SOLAR DECATHLON EUROPE 2010

Towards Energy Efficient Buildings



Virginia Polytechnic Institute & State University, United States of America
Hochschule Rosenheim University of Applied Sciences, Germany
Hochschule für Technik Stuttgart, Germany
École Nationale Supérieure d'Architecture de Grenoble, France
Aalto University, Helsinki, Finland
Bergische Universität Wuppertal, Germany
Arts et Métiers ParisTech, Bordeaux, France
University of Florida, United States of America
Universidad CEU Cardenal Herrera, Valencia, Spain
Hochschule Berlin University of Applied Science for Technology and
Economics + Beuth Hochschule Berlin University of Applied Science for
Technology + University of Arts Berlin, Germany
Tongji University, China
Universidad de Sevilla, Spain
Universidad Politècnica de Catalunya, Spain
Universidad de Valladolid, Spain
University of Nottingham, United Kingdom
Tianjin University, China
Instituto de Arquitectura Avanzada de Catalunya, Spain
Universidad Politècnica de Madrid, Spain



sd europe
SOLAR DECATHLON



ten act10n

Supported by
INTELLIGENT ENERGY
EUROPE

SOLAR DECATHLON EUROPE 2010

Towards Energy Efficient Buildings



sd europe

SOLAR DECATHLON



ten act10n

INTELLIGENT ENERGY
EUROPE

Authors

Solar Decathlon Europe Competition, Origin and Future

Universidad Politécnica de Madrid

Sergio Vega Sánchez

Overview of SDEurope 2010 Competition by the Juries

Glenn Murcutt, Willi Ernst, Dejan Mumovic, Felipe Pich-Aguilera Baurier, Jane Koleeny, Pablo Jiménez García.

Approach to SDEurope2010 Houses Innovations by IDAE

Institute for the Diversification and Saving of Energy

Marcos González Alvarez

Description of SDEurope 2010 Houses by the participating Universities

Virginia Polytechnic Institute & State University, United States of America

Joseph Wheeler, Robert Dunay, Robert Schubert

Hochschule Rosenheim University of Applied Sciences, Germany

Heinrich Köster, Oliver Heller, Mathias Wambsganss, Stefanie Winter, Marcus Wehner, Jan Peters, Gerd Beneken, Werner Braazt, Jürgen

Buchner, Regine Falk, Harald Krause, Franz Feldmeier, Ulrike Förschler, Michael Krödel, Martin Lepsky, Franz Feldmeier

Hochschule für Technik Stuttgart, Germany

Jan Cremers, Sebastian Fiedler

École Nationale Supérieure d'Architecture de Grenoble, France

Pascal Rollet, Nicolas Dubus

Aalto University, Helsinki, Finland

Pekka Heikkinen

Bergische Universität Wuppertal, Germany

Anett-Maud Joppien, Martin Hochrein, Karsten Voss, Soara Bernard

Arts et Métier ParisTech, Bordeaux, France

Denis Bruneau, Philippe Lagiere

University of Florida, United States of America

Mark McGlothlin, Robert Ries, Jim Sullivan, Maruja Torres, Bradley Walters, Russell Walters

Universidad CEU Cardenal Herrera, Valencia, Spain

Fernando Sánchez López, Guillermo Mocholí Ferrándiz, Andrés Ros Campos, Pedro Verdejo, Alfonso Díaz Segura, Manuel Martínez Córcoles,

Elisa Marco, Víctor García Peñas, Nicolás Montés Sánchez, Luís Doménech Ballester, Jordi Renau Martínez, Borja García, Aurelio Pons

Hochschule Berlin University of Applied Science for Technology and Economics + Beuth Hochschule Berlin University of Applied Science for

Technology + University of Arts Berlin, Germany

Friedrich Sick, Susanne Rexroth, Volker Quaschnig, Christoph Gengnagel, Christoph Nytsch-Geusen, Anke Engel, Frank Arnold

Tongji University, China

Hongwei TAN, Quian FENG

Universidad de Sevilla, Spain

Francisco Javier Terrados Cepeda

Universidad Politécnica de Catalunya, Spain

Torsten Masseck, Mónica Tárrega

Universidad de Valladolid, Spain

Jesús Feijó, Alfonso Basterra

University of Nottingham, United Kingdom

Mark Gillott, Robin Wilson, Guillermo Guzman, David Oliver, Michael Stacey, Brian Ford, Lucelia Rodrigues, John Ramsey, Lyn Shaw,

Mike Siebert

Tianjin University, China

Zhijia Chen, Yiping Wang

Instituto de Arquitectura Avanzada de Catalunya, Spain

Vicente Guallart, Neil Gershenfeld, Daniel Ibañez, Rodrigo Rubio

Universidad Politécnica de Madrid

Beatriz Arranz Arranz, Eva Gómez Aparicio

Publication Director

Sergio Vega Sánchez UPM

Editorial Coordination

Mónica Almagro Corpas 10ACTION - UPM
Katja Klinkenberg 10ACTION - UPM

Advisory Board

Sergio Rodríguez Trejo SDEurope - UPM
Edwin Rodríguez Ubiñas SDEurope - UPM

Coordination Support

Helena Echávarri 10ACTION - EMK

Design

Cristina Navas Perona
Javier García-Rivera de la Plaza
Madland Estudio

Layout

Amagoia Aldabaldetrekue
Elena Almagro Corpas

English translation

Participating Universities
Verónica Franco Herrero

Proofreading of English text

Marie-Nathalie Martineau

Photography

Page 159: Fernando Alda
Page 5, 59, 70, 78, 110, 119, 149, 179, 187, 181 and 222: Elena Almagro Corpas
Page 139: living EQUIA / Markus Bachmann
Page 202: Irene Castillo
Page 70: Jan Cremers
Page 100: Amparo Garrido
Page 78, 110, 119, 149, 179, 189, 181 and 202: Alonso Huerta
Page 100: Peter Keil
Page 159: Ricardo Santonja
Page 49: Jim Stroup
Page 119: Pete Vastyán

First edition

September 2011

Book Edition

10ACTION Project
Intelligent Energy Europe Program
© 10ACTION



All Rights reserved; no part of the publication may be reproduced, stored in a retrieval system, or transmitted in any form or by any means, electronic, mechanical, photocopying, recording, or otherwise without prior written permission of the publisher.

The publisher does not warrant or assume any legal responsibility for the publication's contents. All opinions expressed in the book are of the authors and do not necessarily reflect those of 10 ACTION.

The sole responsibility for the content of this publication lies with the authors. It does not necessarily reflect the opinion of the European Union. Neither the EACI nor the European Commission are responsible for any use that may be made of the information contained therein.



ACKNOWLEDGEMENT

With regard to the publication of this book, the Technical University of Madrid (UPM) would like to thank all the people who contributed and/or participated in the Solar Decathlon Europe 2010, from its very beginnings until the end of the competition at the Villa Solar in Madrid. The UPM wants to insist on how much hard work and dedication were invested in this project by all the universities, students, teachers and professionals who contributed to it. Without their active participation, this book would never have been possible.

The help of the American Solar Decathlon team has been inestimable in organizing this event. So far as for the work of more than 500 UPM students, who contributed in various editions of the Solar Decathlon, and of thousands of students from all over the world, which enthusiasm contribute to innovation and constant progress – everything both American and European editions of the Solar Decathlon are about.

Finally, the UPM is especially grateful to the organization teams of the Solar Decathlon Europe and the 10ACTION project, as well as to all the sponsors and institutions who supported it. Many thanks to all of you for making this competition -and its outstanding outcomes- possible.

This book, as is the 10ACTION project, are co-financed by the Intelligent Energy Europe Programme of the EACI.



POLITÉCNICA

Beatriz Corredor Sierra

*Secretary of State for Housing and Urban Development
Spanish Ministry of Public Works*

Energy efficiency and the use of renewal energies in construction are essential elements to combat climate change and to transform the way our buildings and houses are built and retrofitted. In order to promote those elements, the Secretary of State for Housing and Urban Development of the Spanish Ministry of Public Works has believed in the huge potential of the Solar Decathlon Europe to communicate and raise social awareness.

Thanks to the agreement signed with the U.S. Department of Energy and having in mind the worldwide reputation of this competition, we successfully organized the first edition outside the United States. This success had a worldwide impact and allowed us to meet the commitment made with our American partners, with whom we share the target of trying to change the energy design of buildings.

Solar Decathlon Europe has contributed to raise awareness about an important element of our policies: the effort to make construction a more energy efficient process and to prove, by making an intelligent use of renewal energies, in this case the sun, that achieving energy self-sufficiency and even transforming buildings into energy generators is possible. That would reverse the problem without affecting other aspects of buildings.

The SDE 2012 edition, in which collegiate teams from 15 countries and four continents will participate, will be the most international edition of a Solar Decathlon so far. This participation is clear proof of the national, European and international interest aroused by the 2010 European Solar Decathlon. The attendance success, the enthusiasm shown by the participating teams, the interest of the private sector in supporting it, the prestige achieved thanks to the prize it was awarded by the European Commission during the Sustainable Energy Week, and the institutional support from the Commission make us believe in the success of the next edition, in 2012, which we, the Spanish Government, support.

Thus, it seems important to compile in a book the most relevant information collected during the competition held in June 2010, so that there is visual and written evidence of the lessons learned. More people, including those who did not have the opportunity to visit the Villa Solar in June 2010, will be able to study and learn about it.

We would like to congratulate and thank all those who contributed to the creation of this book, especially our main collaborator: the Universidad Politécnica de Madrid, whose deep knowledge of the competition, after having participated as a team in three American editions, and its technical support to organize it have been crucial for the success of the Solar Decathlon Europe.

William Gillett

Head of Unit for Renewable Energy

Executive Agency for Competitiveness and Innovation European Commission, Brussels

The EU is committed to the reduction of its greenhouse gas emissions by 20%, mainly by using energy more efficiently and by increasing the overall share of renewable energy up to 20% of the final energy consumption by 2020. In order to achieve these commitments, a legal framework has been set through the adoption of EU Directives on renewable energy and on energy efficiency. Yet, a lot more effort is needed by public and private organisations, as well as by individual citizens in order to honour these commitments through concrete investments and actions on the ground.

The Intelligent Energy – Europe [IEE] program aims at helping the EU to achieve its 2020 targets by supporting public and private organisations from different EU Member States, making them work together on projects which accelerate energy saving and encourage the use of renewable energy sources.

Today, buildings account for around 40 % of energy use in Europe. It is therefore crucial to find attractive and affordable ways to reduce “conventional energy” consumption in buildings. About what is being done across the EU to make buildings more energy efficient and to substitute the use of conventional energy with renewable energy in buildings, additional information can be found on the internet portal BUILD UP (www.buildup.eu), which is supported by the IEE program.

Against this background, the IEE program is supporting the 10ACTION project, which goal is to broadcast the outcomes of the Solar Decathlon Europe competition so to raise awareness about energy efficiency and renewable energies in buildings. The 10ACTION project targets five different groups including children, teenagers, university students, professional businesses and the general public.

The Solar Decathlon produces exciting designs and concrete examples of how solar and other renewable energies can be used together with the latest energy efficiency measures in buildings. These projects already proved attracting a wide range of visitors to the Solar Decathlon Europe exhibition. We hope future visitors will spread the word to friends and contacts, and will be so inspired by what they have seen that, back home, they will replicate these ideas in their own houses, businesses, and regions.

By publishing this book, the 10ACTION project wants to reach a wider audience. By presenting in detail awarded buildings of the Solar Decathlon Europe, it aims at informing designers and building owners across the EU, as well as inspiring students who are just embarking on careers in the building sector.

If readers of this book find the winning designs of the Solar Decathlon inspiring; if they maybe adopt some of the strategies and exciting ideas these projects feature for their own houses, businesses, and regions, then this initiative of the Intelligent Energy Europe program will have proved worthwhile, well spending the EU tax payers' money.

A MILESTONE IN THE DESIGN AND CONSTRUCTION OF THE BUILDINGS OF THE FUTURE

Alfonso Beltrán García-Echániz

Director of the Institute for the Diversification and Saving of Energy (IDAE)

Energy efficiency and renewable energies are two sides of a coin, as both are essential if we want to reach our objectives on reduction of the greenhouse effect, and cut back our energy dependence on foreign countries. Both aspects are not to miss if we want future generations to keep enjoying a welfare equivalent or higher than ours. Luckily in our case, environmental and economic objectives go hand in hand.

IDAE has been working on energy efficiency and renewable energies for 25 years, and in this sense it has played the role of a catalyst in the development of various sectors, some of which are tokens of success in Spain.

Buildings correspond to approximately 26% of the entire energy consumption in Spain, a percentage that soars up to 40% for the whole European Union; residential buildings account for 17.5% of the whole national consumption. IDAE has worked hand in hand with other administrations to cutback the energy demand and increase the use of renewable energies in buildings.

Moreover, both the Spanish National Plan on Saving and Energy Efficiency and the National Plan on Renewable Energies state specific objectives or measures to reduce energy consumption in buildings, or integrate renewable energies in them. These measures aim at reducing the energy demand, improving the performance, and/or integrating renewable energies in installations and buildings.

IDAE also plays an important role in collaborating with other administrations for the development of buildings' regulations, such as the Technical Building Code, the Regulations on Building Heating Installations, or the Building Energy Certification.

The recent publication of the Directive 2010/31/EU, according to which all the buildings built in Europe will have, from year 2021, to be Nearly Zero-Energy Buildings, compels us to work hard in order to achieve these objectives. Of course, the efficiency level requirements that ought to be established will be remarkably increased, as well as the use of clean energy in buildings.

Bearing in mind all of the above, the celebration in Spain of the Solar Decathlon Europe 2010 represents a milestone in the design and construction of the buildings of the future, placing us ahead of the European and world avant-garde. It is a useful laboratory where both professionals and the general public can experience the building typology that awaits us around the corner.

SOLAR DECATHLON, A GROUNDBREAKING COMPETITION

José Manuel Páez

Vice-Rector for International Relations of Universidad Politécnica de Madrid

The Universidad Politécnica de Madrid first participated in the Solar Decathlon (SD) competition in 2005. With the support of the company ISOFOTON (a spin-off of our university manufacturing photovoltaic solar panels), we then took on the challenge of presenting the only European project of this U.S.-based competition. From that moment on, the UPM participated in three editions of the Solar Decathlon. We built five houses and have been in charge, under the leadership of the Spanish Ministry of Housing, of organizing the first Solar Decathlon Europe (SDE). In this 2010 competition, seventeen teams from seven countries and three different continents competed in a collegiate spirit, attempting at building the most energy wise, self-sufficient house prototype. The competition was held, for the very first time, outside the United States, and therefore attracted the highest international representation ever.

From 2005 until today, more than 150 professors, students and professionals from different sectors have been directly involved in our different SD projects. Graduate students, post-graduate students and professors (especially from the Schools of Architecture, Telecommunications, and Industrial Engineering as well as from the IT Faculty) participated -and still actively do- in the design, manufacturing, logistics, organization and maintenance of our prototypes. The SD program provided the UPM with essential knowledge about the development of international competitions and multidisciplinary projects on the one hand, as well as about the permanent search for financing and sponsorship, on the other.

As an academic institution, we must draw lessons from previous projects and past researches. In pursuing our educational mission, we must think of, and properly organize knowledge transfer to both social and productive sectors. The involvement and participation of the UPM in the last three editions of the SD has allowed our teams to learn and develop new technologies; to materialize them into actual house prototypes; and to eventually incorporate them into the academic activities of our university. Among the most significant outcomes of the SD program at UPM, we count several final projects and post-graduate thesis based on SD projects; participation in more than ten national and international strategic projects, realized in collaboration with companies related to the field; the creation of twenty new research projects on construction and related technologies; several scientific publications in important journals, as well as recognition of more than fifteen patents.

The UPM is proud of the professors, students and external professionals who participated in the SD program. Their dedication, effort and determination - the many different ways in which they carried on this "adventure" make them pioneers in our country. We encourage the university community to support further innovation and initiatives like the SD. They make disciplinary integration and the re-engineering of existing technologies key elements leading towards a cleaner, better, and fairer world.

FROM WASHINGTON TO MADRID

Richard J. King

Director of the U.S. Solar Decathlon Competition

In September 2002, the first U.S. Department of Energy Solar Decathlon was held on the National Mall in Washington D.C. Fourteen pioneering collegiate teams from around the United States designed and built energy-efficient houses powered exclusively by the sun for this first-of-its-kind competition. The teams' leadership and vision made the inaugural event a success.

The goals of the Solar Decathlon remain the same as they were almost a decade ago. The competition still seeks new and innovative solutions to several key issues that we face today: climate change, the need for energy-efficient housing, and an educated workforce. After the first Solar Decathlon, it became evident that these issues were global, requiring everyone around the world to work together toward a common goal.

When the second Solar Decathlon was announced for 2005, international universities were invited to participate. One university in particular stood up to join and compete with the Americans: the Universidad Politécnica de Madrid. Everyone immediately fell in love with the Universidad Politécnica de Madrid's entry, called the "magic box." As the Spanish nation watched from afar, they too were impressed with the team. The "magic box" performed well and gained much respect.

When the team returned to Spain, the Universidad wanted to expand the educational benefits of the competition throughout Europe. Thus the seeds for the first European Solar Decathlon were planted. In 2007, an agreement was reached with the U.S. Department of Energy to create Solar Decathlon Europe.

Thanks to the Spanish Ministry of Housing and the Universidad Politécnica de Madrid, the Spanish people were the first in Europe to experience the excitement created by a competition among 20 universities striving to design and build the most innovative home. When I arrived in Madrid in June 2010, I was so excited. The first thing I did was run down to the Villa Solar to see what the teams had built. What I found was inspiration. I was inspired by the designs, the creativity, and the hard work. I wasn't the only one. Soon, thousands of people joined me in touring the houses.

I want to thank the organizers and especially the university teams from around the world who worked for two years to design and build the houses for the first Solar Decathlon Europe. Their passion and leadership made the international event a wonderful success. They helped change the world for the better. That makes us all winners.

VALUES FOR THE FUTURE

THE IMPORTANCE OF THE SOLAR DECATHLON EUROPE 2010 COMPETITION FOR THE MAIN SPONSORS

Ricardo de Ramón, Country President Spain, Portugal and Morocco of Saint-Gobain

Enrique Valer, Country President Spain, Portugal and South America of Schneider Electric

Rafael Rodríguez, Country President Spain and Portugal of Rockwool

José Ramón Navarro García, Country President Spain of Kömmerling

Baldomero Falcones Jaquotot, President and CEO of FCC

The Solar Decathlon Europe 2010 was a great event endowing “values for the future” for better buildings such as sustainability, technology, innovation and collaborative working.

Its great public impact and media coverage contributed to the development of knowledge, and helped reaching a broader acceptance of advanced solutions and technologies improving the energy efficiency of buildings.

In raising awareness about energy efficiency, and in supporting sustainable, day to day solutions for buildings, the Solar Decathlon Europe meets with our own objectives.

The competition was a great occasion to bring to the public innovative technologies and design strategies for buildings – all that in a very beautiful environment. Such technologies could also be tested, and led towards original collaborations between the scientific world and the business sector. Several collaborative researches were conducted together with businesses. Solutions and outcomes from these researches were successfully applied to the Solar Decathlon’s prototypes which used, tested, and presented new products available on the market.

As a result, the competition encouraged similar initiatives from different organizations throughout Europe, therefore increasing the number of activities explaining the values we share with the Solar Decathlon Europe.

The Intelligent Energy Europe 10ACTION project helps spreading out the outcomes of the Solar Decathlon Europe. This book will be an instrument for both the education and broadcasting of the “values for the future”.



SUMMARY

SOLAR DECATHLON EUROPE COMPETITION ORIGIN AND FUTURE

by Sergio Vega 15

OVERVIEW OF SDEUROPE 2010 COMPETITION BY THE JURIES

Speech at the Architecture Contest Award Ceremony

by Glenn Murcutt 27

Exciting Solar Designs at Solar Decathlon Europe 2010: Building- Integrated Systems were the main innovative Attractions

by Willi Ernst 28

Engineering and Construction in the 21st Century Context More for Less

by Dejan Mumovic 31

Solar Decathlon 2010 Afterthoughts

by Felipe Pich-Aguilera Baurier 33

Catalyst for Change: The Solar Decathlon makes its Debut Overseas

by Jane Kolleeny 35

Industrialization and Market Viability Jury Evaluations

by Pablo Jiménez 37

APPROACH TO SDEUROPE 2010 HOUSES INNOVATIONS BY INSTITUTE FOR THE DIVERSIFICATION AND SAVING OF ENERGY

Insulation 40

Solar Protection Devices 41

Thermal Storage 42

Heating and Cooling Systems 43

Solar Systems 44

DESCRIPTION OF SDEUROPE 2010 HOUSES BY THE PARTICIPATING UNIVERSITIES

LumenHAUS™

Virginia Polytechnic Institute & State University, United States of America 46

Team IKAROS Bavaria

Hochschule Rosenheim University of Applied Sciences, Germany 56

home+

Hochschule für Technik Stuttgart, Germany 66

Armadillo Box

École Nationale Supérieure d'Architecture de Grenoble, France 76

Luuku House

Aalto University, Helsinki, Finland 86

Team Wuppertal

Bergische Universität Wuppertal, Germany 96

Napevomo

Arts et Métiers ParisTech, Bordeaux, France 106

RE:FOCUS

University of Florida, United States of America 116

SML House

Universidad CEU Cardenal Herrera, Valencia, Spain 126

Living EQUIA

Hochschule Berlin University of Applied Science for Technology and Economics + Beuth Hochschule Berlin University of Applied Science for Technology + University of Arts Berlin, Germany 136

Bamboo House

Tongji University, China 146

Solarkit

Universidad de Sevilla, Spain 156

LOW3

Universidad Politécnica de Catalunya, Spain 166

URCOMANTE

Universidad de Valladolid, Spain 176

Nottingham H.O.U.S.E.

University of Nottingham, United Kingdom 186

Sun Flower

Tianjin University, China 196

FabLab House

Instituto de Arquitectura Avanzada de Catalunya, Spain 206

Prototype SDE 10

Universidad Politécnica de Madrid, Spain 216

CREDITS

226



Sergio Vega Sánchez, Dr. Architect, PMP

Professor at the E.T.S. de Arquitectura, Universidad Politécnica de Madrid.

Director of the Master's Degree in Construction Quality Control.

Researcher of the TISE (Innovative and Sustainable Techniques in Building) Group General.

Director-Project Manager of the SOLAR DECATHLON EUROPE Competition.

Main researcher of the 10ACTION project.

One of the top priority, and strategic issues of the European Union and of the world in general is their concern for **sustainable development**, which, despite its general interest, is short of content. An important effort needs to be done in order to disseminate the issues that are related to it, and bring it to the public's attention.

The process of sustainable development was promoted worldwide in Rio de Janeiro in 1992 and in Johannesburg in 2002. It is defined as follows: a **“development that meets the needs of the present without compromising the ability of future generations to meet their own needs”**. Since housing and construction are **responsible for 40% of the consumption of raw materials, for 40% of energy consumption, for a big percentage of waste** (directly or indirectly related to construction processes), and for **a significant use of water and chemical products**, it is essential that we (architects, builders) become more aware of such aspects.

In our field, it means that we must be able to **promote and construct buildings in which not only technical and economic, but also social and environmental aspects are important in meeting our needs and the needs of the generations to come**. Some of the main characteristics of a sustainable dwelling are as follows:

- The house should be located in an environmentally friendly place, and designed in such a way that it can take advantage from **bioclimatic factors**, while using as little ground as possible.
- The house should have a low energy consumption; design and materials should minimize energy needs and improve the efficiency of the building and its systems.
- Most of the energy should come from **renewable resources**: solar thermal and PV, wind, geothermal energy, etc.
- When possible, renewable materials should be used, opting for recycled materials or at least recyclable ones.
- The house should integrate solutions and systems demanding few water and chemical products, and presenting as little embodied energy as possible (life cycle cost).

THE PROBLEM WITH ENERGY

Climate change and dependence on imported energy mean a high economic cost for EU countries – a cost that will keep increasing in the future.

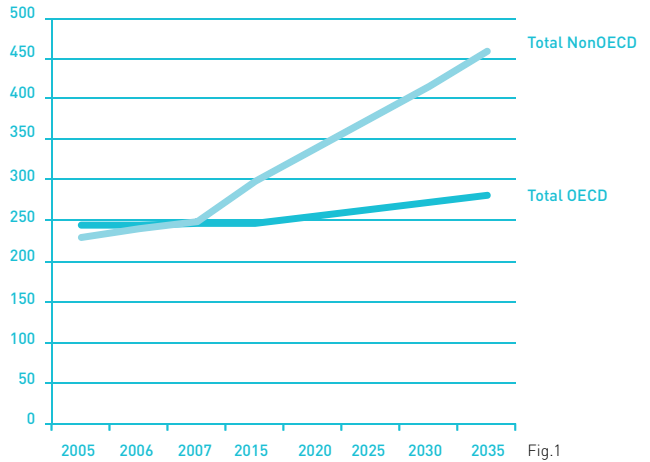

Three main problems are ensuing from this:

The Geo-Strategic and Political Issues of Energy Dependence

Natural resources are unevenly distributed in the world: some countries have a lot of energy raw materials, while others have to buy it at a price established by the market. Energy dependence is a weakness for most of European economies, since they to a large extent depend on oil, gas and coal, i.e. energy sources coming from unstable, and very often non democratic countries.

A significant increase in energy demand and prices

Although the population of OECD developed countries is practically steady, the population of the world is constantly increasing. The global increase in population, its concentration in cities, and the development of emerging countries lead to a big increase in energy needs.

Although oil, gas and coal will be available for many years still, resources are limited. Newly discovered oilfields are more difficult to exploit; consequently, extraction costs are progressively increasing. Moreover, handling and transportation cause major environmental problems in the short-term. Although nuclear energy remains an option in developed countries, the risks it entails is less and less accepted by Western societies; we therefore try to limit its use in more unstable regions.

Consequently, **energy-related costs are likely to explode within the next few years** – not to mention the very problem of supplies. Europe's lack of resources makes us highly dependant on other countries which are our rivals in the industry.

Climate change

The planet is known to have undergone dramatic climatic changes which have been linked, by a large consensus, to greenhouse gases (GHG). Most of the CO₂ emissions, which is considered the main greenhouse gas, are attributed to energetic usages. Both direct and indirect emissions ensuing from human activities are associated with **coal, oil and gas burning**. The concentration of GHG in the atmosphere directly affects the global temperature, with potentially global, dramatic consequences. Without any doubt, *it is indispensable to define an objective of maximum emissions*, in order to limit problems in the future.

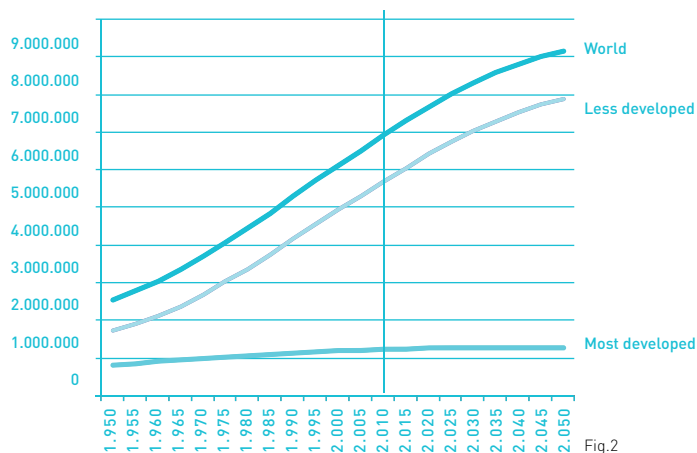

Fig.1 World energy consumption (projection) Quadrillion Btu
 Source: International Energy Outlook 2010: Reference Case Projection Tables [2005-2035]. U.S. Energy Information administration OECD
 Australia, Belgium, Chile, Denmark, France, Greece, Iceland, Israel, Japan, Luxemburg, Netherlands, Norway, Portugal, Slovenia, Sweden, Turkey, USA, Austria, Canada, Czech Republic, Finland, Germany, Hungary, Ireland, Italy, Korea, Mexico, New Zeland, Poland, Slovak Republic, Spain, Switzerland, United Kingdom.
 Fig.2 World population (projection) Thousands of people
 Source: World Population Prospects: The 2008 Revision. Medium Variant United Nations Division. More developed regions comprise Europe, Northern America, Australia, New Zeland and Japan. Less developed regions comprise all regions of Africa, Asia (excluding Japan), Latin America and the Caribbean plus Melanesia, Micronesia and Polynesia.

Fig.2

TURNING THREE MAJOR PROBLEMS INTO OPPORTUNITIES

Taking the necessary measures to mitigate the effects of climatic changes forces us to change radically our development model by phasing out the use of oil, gas or coal; by improving the energy efficiency of our buildings and cars, and by diversifying the energy mix through innovations and the use of renewable energies – all of which also represent a *good opportunity to innovate and to gain some competitive advantage over other countries.*

INTERRELATIONS BETWEEN CONSTRUCTION AND ENERGY SECTORS

In buildings, we mainly use two forms of energy: electricity and heat.

Electricity

A large part of **the energy consumed in buildings (both for their construction and their operation) is electricity.** Its provenance and ecological footprint depend on what the grid offers rather than on the preferences of the user.

Electricity is usually produced in big plants, transported and distributed (very often altered in the process of carrying), and finally consumed. To make it cleaner, we need to intervene at three different levels:

- **Generation:** *The energy mix* designate the mix of sources generating electricity. In developed countries it usually comes from the combustion of gas, coal or oil-derived products, and/or from nuclear, hydroelectric, solar or wind power plants. We want a **safe, non-polluting electricity production**; but we need to **guarantee the supply. Renewable sources are intermittent** (it is not always sunny or windy and it does not rain everyday), and **we do not have many electricity storage systems.**

The Spanish energy mix, for example, is quite diversified. The renewal energies supply average is nowadays 31.7%, especially of wind power and, to a lesser extent, of solar energy. Our objective is to reach 40% of renewable energy sources by 2020.

- **Transportation, transformation and distribution.** Energy is very often produced far from the location where it is consumed. Important losses and a significant amount of CO2 emissions are associated with energy transportation (electricity is carried in high voltage in order to minimize the losses) and with its transformation (it has to be turned into low voltage for its use). **The current trend is to focus on a distributed production:** the idea is **to produce, so far as possible, most of the energy that is needed in the building itself, or in the district or the city where it is located,**

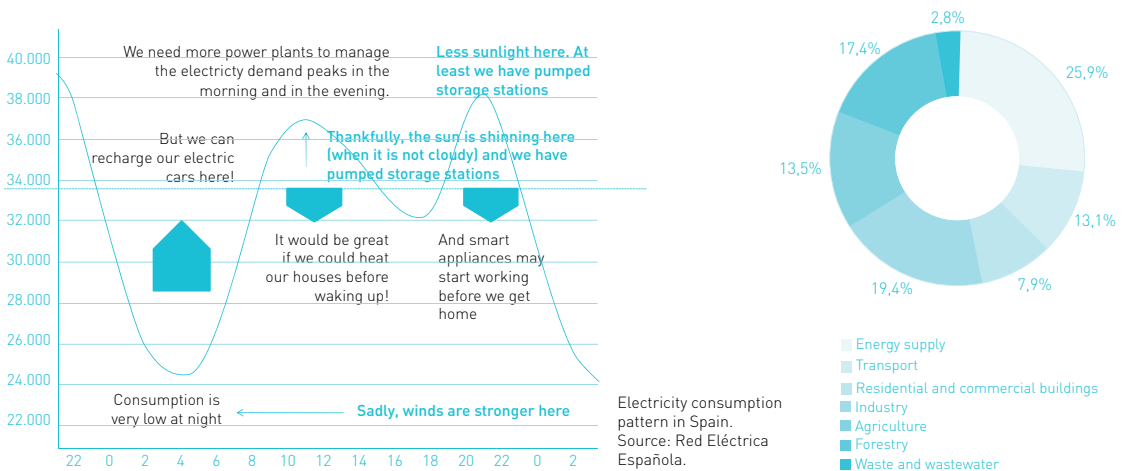

so that it does not need to be transported. This type of energy production, however, tend to be more expensive and less reliable. In any case, we need to find an adequate **balance between on-site energy production and big power stations supplies**, so to provide a certain stability for this type of systems.

- **Consumption.** We do not need only to reduce the electricity taken from the grid, but also to adjust as far as possible the demand to the production and vice versa. Nowadays, there are big differences in energy consume between some particular time slots, and controlling and adapting them is difficult, since, for example, it takes a long time stopping and starting a nuclear power station, or we cannot be sure there will be wind or sun when we need it.

We can work on **stabilizing the demand** and on adjusting the production to the demand. There is scope **to use night hours**, for example, for increasing the demand, by using household appliances, batteries or electric car recharges, etc. Increasing the thermal inertia of buildings could as well be tremendously useful: energy consumption peaks could significantly be reduced if houses were heated or cooled mainly overnight.

In order to improve the efficiency of the power grid, technologies of so-called **“smart grids”** are being developed. Three levels of action are at play here:

- **We can intervene on the European power grid and on national power grids**, which regulate and balance the power grid. We need to guarantee a production adjusted as closely as possible to the demand, and **manage it in an intelligent way**. Most of the European power grids are perfectly interconnected, regulated and optimized.

- We can work on the development of **local and district “smart grids”** in order to control the energy produced in districts and cities according to the concept of **distributed production, which can be much more efficient. If the demand is controlled and if energy storage systems are implemented, the system can be very efficient.** The arrival of **electric cars** can do a great deal here. If slowly recharged (during more or less eight hours) at home overnight, we could make good use of electricity that we are already producing and that is not being used. While, of course, refraining from using petrol, and therefore avoiding pollution related to it.

- We can improve the **building** itself, by enabling energy generation (*micro-generation*) in order to meet, totally or partially, its own energetic demand. *Demand management systems* and the adjustment of the consumption to the availability (price) of the energy would help regulate and balance the demand; consequently, energy would be used much more efficiently at any time. Along with this, we must implement consumption measuring technologies (at each electricity line in houses) or smart systems that automatically optimize energy consumption. Finally, establishing pricing policies that would adjust prices to the demand (more or less expensive according to a high or low demand)

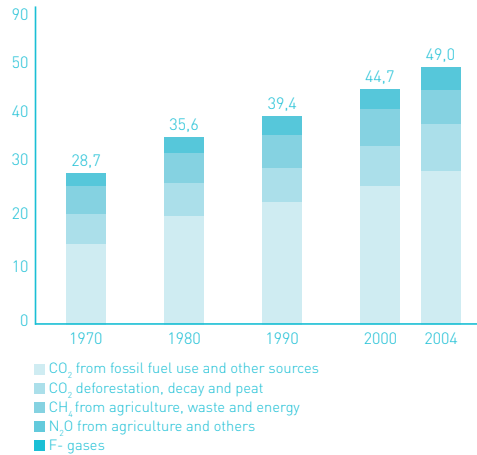
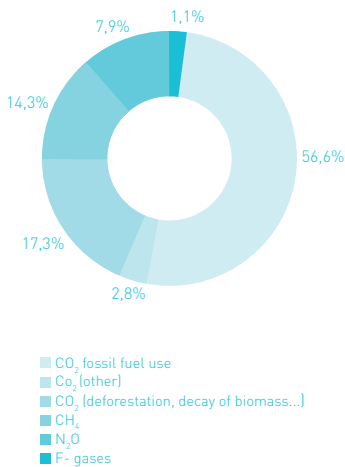

Includes only carbon dioxide (CO₂), methane (CH₄), nitrous oxide (N₂O), hydro fluorocarbons (HFCs), perfluorocarbons (PFCs) and sulphurhexafluoride (SF₆), whose emissions are covered by the UNFCCC. These GHGs are weighted by their 100-year Global Warming Potentials (GWPs), using values consistent with reporting under the UNFCCC.

Source: IPCC Fourth Assessment Report, Climate Change 2007 (AR4). Fig. 2.1. Publisher: Cambridge University Press.

would also help reaching a better energy efficiency.

Heat

A large part of the energy requested by buildings are related to heating and cooling. In many countries, big plants produce the heat that is needed in districts or in cities. In Spain, heating or cooling are always generated in the building, reducing transportation losses; the production is less efficient though. On the whole, efficiency depends on how much money is being invested by users in equipment and in its maintenance. District systems represent a more balanced solution.

Electricity production usually generates some residual heat. It is essential to analyze both processes all together, attempting at combining both in order to reach a maximum energy efficiency. Cogeneration systems in buildings and districts (district heating) can be a good solution.

In sum, with regard to the interrelation between construction and energy, we must keep in mind that decisions about **how to improve existing buildings, and about regulations that should be imposed for future constructions will have an impact on other sectors**: opting for *micro-generation* will affect the structure of the power grid (fewer power stations and fewer energy transportation networks); *demand management* would not only ease congestion in electric networks, but could also have a decisive influence on the energy consumption related to the transportation sector with the use of electric cars.

THE ROLE OF BUILDING

Buildings have a determining role, since they are responsible for a **large part of energy consumption, and for a significant amount of CO₂ emissions**. We can reduce its impact by consuming less energy, and by making sure that the production of the energy that is consumed release fewer Greenhouse Gas (GHG).

Reducing the consumption is the first, crucial step. Producing the same amount of energy with equal, fewer, or no GHG emission is, to this day, technically and economically unfeasible.

More precisely, we speak of:

- **A significant reduction of the demand.**

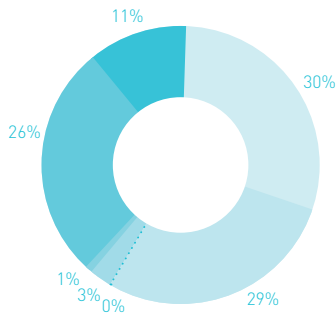

Final Energy Consumption by sector: EU27 (2008)

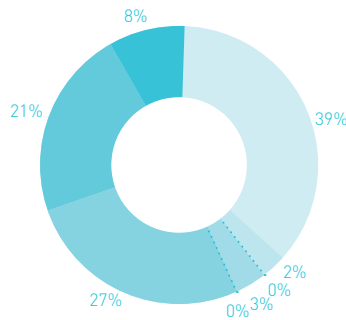

Electricity consumption by sector + losses: EU27 (2008)



Sources Graphics: Solar Decathlon Europe. Data on consumption: Eurostata. Data on emissions: IEA
 Next page: Challenge: try to find your own country's figures and guess why are so similar/ different to the spanish example. Source: IDAE

- Increasing the efficiency of the systems meeting the demand.
- Implementing **non-pollutant systems, preferably based on the use of renewable energies.**

European buildings use fuels and electricity mainly for heating and water heating demands, and incidentally for lighting, cooling and electrical household appliances.

The reduction of the demand requires, first and foremost, a change in **behaviours, i.e. raising awareness and finding ways for users to make a better use of the building.** Secondly, a **higher efficiency** can be reached by improving the **features of the built** envelope, and of the systems and equipments that consume electricity or burn fuel. Finally, these improved systems should use **renewable sources of energy.**

Due to the dimensions of the existing urban land and its constant growth (more than 80% of the globe by the year 2020), together with the **almost unstoppable wave of population growth and of economic development**, new urban developments will be limited in developed countries, so the **main action in building should be focused on energy retrofit without forgetting the challenge of achieving that all the new buildings must be "nearly zero-emissions" buildings.**

In order to carry out more relevant actions, we also need to better document the ways in which energy is used in actual, existing buildings, so that we can clearly identify where it is worth investing, find strategic ways to reduce consumption, and propose accurate ways to do it. The distribution of the consumption in Spain, for example, is as follows:

THE EUROPEAN COMMITMENT

The European Union is strongly committed to improving the conditions of sustainability for our societies, an objective that has been translated into the 20-20-20 targets. The 20-20-20 targets are as follows: reducing EU greenhouse gas emissions by at least 20% below 1990 levels; lowering by 20% the projected levels of use of primary energy, by means of energy efficiency improvements; and reaching 20% of renewable energy sources in supplying the demand. In addition to this, the EU also proposed to reach a reduction of 30% of emissions if ongoing negotiations lead to a serious commitment from other developed or developing countries. The objective of Spain to reach 40%.

These objectives are included in three European Directives that have been developed to this end:

- Directive 2002/91/EC [...] on the energy performance of buildings. Member States are bound to lay down some

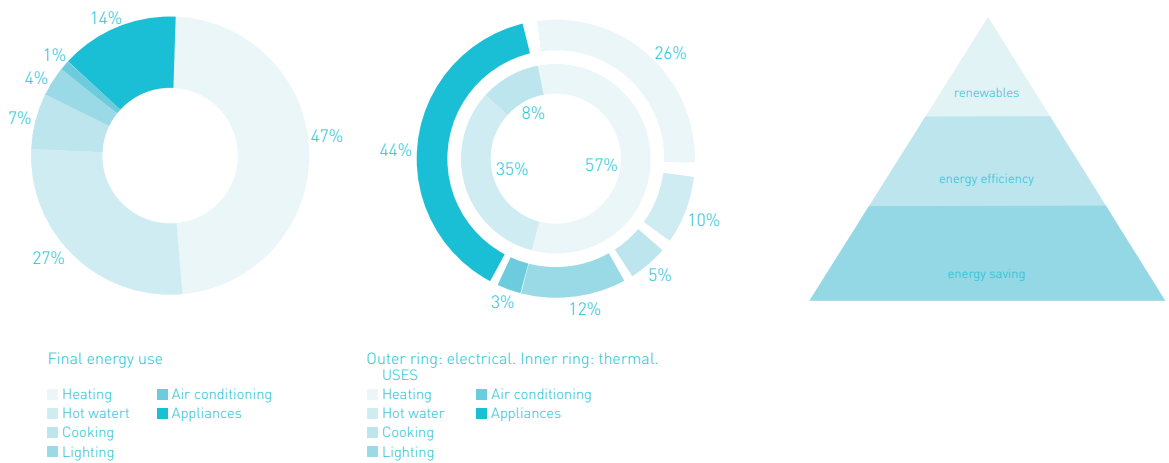

minimum requirements on existing and new buildings, to certify the efficiency of the use they make of energy and to plan regular inspections of boilers and air-conditioning systems.

- Directive 2009/28/EC [...] on the promotion of the use of energy from renewable sources [...]. It lays down a 20 % target for the overall share of energy from renewable sources by 2020 and a 10 % specific target for energy from renewable sources in the field of transport, besides other essential measures for the development of these sources.

- Directive 2010/31/EU [...] on the energy performance of buildings (recast). It is a recast of the 2002/91/EC that includes the amendments considered necessary eight years later. Among others, we would like to point out the promotion of “*nearly zero-energy buildings*”. By 31 December 2020, all new buildings shall be nearly zero-energy buildings and two years before, new buildings owned by public authorities shall be nearly zero-energy buildings. In addition to these three Directives, a new Directive on Energy Efficiency, proposed on June 22nd, 2011, brings a step further measures that would help reaching the 20% reduction target in energy demand – which, out of the three 20s, seems to this day the least feasible (since estimated to only 9% following actual rates). This new Directive establishes regulations about direct heating, cogeneration, heating and cooling plans, as well the support of public bodies to energy saving in each country.

The relation between the investment (costs) and the effectiveness of such measures could be represented by a simple pyramid, in which investing in **energy saving** is the most effective one. Consequently, **raising social awareness** is essential (switching lights off when leaving a room has a higher saving potential and is more profitable than covering everything with solar panels). In any case, **improving energy efficiency** is also necessary in order to reduce the energy demand of buildings. Finally, we need to obtain the (fewer) energy that would still be required from **renewable, low-polluting sources**.

European policies and targets ensuing from these Directives states the following priorities:

- **Generating the necessary knowledge** to develop new technologies that would render possible energy savings by improving the energy efficiency of buildings, their equipments and appliances, and by producing, storing and distributing clean, renewable energies in the most efficient way. Such efforts and innovations are essential if we want to **gain a competitive advantage** over other, non-European countries.

- Equally, **knowledge transfer to the industry** is essential, so to **turn these efforts, innovations, and competitive advantage into concrete, efficient industrial products**.



Top: Solar Village in National Mall, Washington D.C

Bottom: UPM Magic Box 2005, UPM Casa Solar 2007 & UPM Casa Black & White 2009



• **Disseminating this knowledge** among technicians and companies working in various related sectors is also essential. This way, we can **generate a critical mass of professionals that would productively integrate innovations to their “know-how” and daily routine.**

• Finally, **raising social awareness** at every level, from children to the general public, is essential, so we can all make a responsible use of energy.

The aim of this book is to compile experiences from the SOLAR DECATHLON EUROPE and from the 10ACTION projects, two initiatives of the Spanish Government (the Secretary of State for Housing and the Institute for Diversification and Saving of Energy, or IDAE), the Madrid City Council and the Universidad Politécnica de Madrid, promoting innovation, knowledge transfer and activities related to the priorities aforementioned.

THE SOLAR DECATHLON EUROPE COMPETITION

The Solar Decathlon is a competition organized by the U.S. Department of Energy that first gathered teams from mainly American universities. Teams were asked to design and build self-sufficient, solar-powered houses equipped with technologies enabling maximum energy efficiency. Their houses were built and exhibited at the “Solar Village” of the National Mall, Washington D.C., where they were evaluated and competed within ten different categories (Decathlon).

The Universidad Politécnica de Madrid, which is highly committed to sustainable development, participated in three different editions of the American competition: in 2005 with the MAGIC BOX house, in 2007 with the CASA SOLAR and in 2009 with the BLACK&WHITE house.

As a result of the active participation and commitment of the UPM, the Spanish Government and the American Government met at the CASA SOLAR and signed, in October 2007 (during the 2007 edition), a Memorandum of Understanding (MOU). By virtue of this agreement, Spain would organize two editions of the competition in Madrid, where participant would come from mainly European universities. It resulted in the SOLAR DECATHLON EUROPE 2010 international edition, which is the object of this book; the forthcoming 2012 edition is currently being developed.

When the Spanish Government, through the Ministry of Housing, asked the Universidad Politécnica de Madrid to organize these two editions of the competition, they specified two main objectives:

- First, promoting innovation and knowledge so to improve the performance of systems, increase energy efficiency

Points distribution per contests in Solar Decathlon Europe 2010

Areas	Contests	Points
ARCHITECTURE	1 Architecture	120
	2 Engineering & Construction	80
SOLAR	3 Solar Systems	80
	4 Electrical Energy Balance	120
COMFORT	5 Comfort Conditions	120
	6 Appliances	120
SOCIAL & ECONOMIC	7 Communications & Social Awareness	80
	8 Industrialization & Market Viability	80
STRATEGIC	9 Innovation	80
	10 Sustainability	120

1000 points

of buildings, integrate renewable energies, and help achieving conditions of sustainability for cities and buildings. Knowledge transfer to the industry and to professionals was also emphasized, aiming at progressively creating a critical mass of technicians who would integrate innovative, eco-energetic solutions to their day to day design and activities.

- Second, taking advantage of the social and media interest aroused by the competition to make society, from children and youngsters to the general public, more aware of the importance of using energy responsibly. Improving the energy efficiency of our buildings, equipments, bulbs, etc., and developing ways to exploit renewable energies are, in short, ways of together creating a more sustainable world.

The first edition of the SOLAR DECATHLON EUROPE competition was launched in 2008. It reached its final stage in June 2010: a Villa Solar was settled in Madrid in the surroundings of the Manzanares River, between the Puente de Segovia and the Puente del Rey.

Seventeen universities reached the final stage of the competition, whose houses are presented and analyzed in this book. They competed within ten different categories (Decathlon) which were organized in five areas, after what the houses were attributed a cumulative mark out of a total of 1000 points (see figure above). The contests focused on ten aspects promoted by the competition:

The attribution of the 1000 points was based on objective quantitative measurements on the one hand, and on the evaluation of 6 juries formed by eighteen international experts on the other. Jury members evaluated the following aspects: architecture, engineering, solar systems, communications, industrialization and sustainability.

In order to fulfil the objectives above mentioned, more than 75 different activities were organized (during the competition and the months before). Activities were intended for all type of audiences, and aimed at raising social awareness on various aspects related to a responsible use of energy, and conditions of sustainability for houses and cities. The outcomes of these activities couldn't be more positive:

- Hundreds of university students from various countries and continents were trained and informed about possibilities of improvement, as well as innovative architectural and technological solutions regarding energy efficiency and conditions of sustainability for buildings and cities.
- More than 192,000 visitors attended the competition venue, therefore creating great opportunities for communication and raising awareness.
- More than 268,000 persons from more than 157 different countries visited the website www.sdeurope.org both during the previous months and during the competition.



- More than 5,000 media entries were counted worldwide (about 2,000 registered in Spain); we estimate that more than 400 million people potentially accessed direct information about the event.
- The competition was hard-fought and exciting until the very last minute. The ambiance was one of fairness and cheerful celebrations. The competition culminated in a very gratifying way, by enriching the experience all participants decathletes.

THE 10ACTION PROJECT

In pursuing and complementing the scope of activities developed through the SOLAR DECATHLON EUROPE 2011, a great amount of activities are being developed all over Europe as part of the 10ACTION project.

The Universidad Politécnica de Madrid and the IDAE (Institute for Diversification and Saving of Energy, State Secretary for Energy) are leading the 10ACTION project, an initiative actively supported by more than twelve European countries. The Technische Universität Darmstadt, the Austrian, Greek and Portuguese Energy Agencies (AEA, CRES and ADENE), and EMK company are also contributing to the project.

The objective is to encourage a change in European citizens' behaviours, by promoting education, social awareness and the dissemination of knowledge. The project promotes a responsible use of energy, higher energy efficiency, the integration of renewable energies and the improvement of the conditions of sustainability for buildings and cities.

The action plan targeting five different groups (children, youngsters, university students -all of them represent the future in some way-, professionals from the field and the general public), for which all the activities are intended. Additional information about 10ACTION project activities can be found at www.10action.com

Among the many activities that are being organized, especially interesting are the games and competitions for children and teenagers. Trainings and debates organized for European university students are also important, as well as a competition named "MORE with LESS (emissions)".

The International Architecture Competition, organized by the Universidad Politécnica de Madrid, is also worth mentioning. The competition opens up great possibilities for bringing innovations developed within the sphere of the SDEurope to the market, addressing the questions of higher density and more sustainable typologies.

The objective of the competition (which is divided in two main steps: the call for proposals, and the development of projects), is to contribute to new ideas ensuing from the knowledge, technologies, systems and strategies developed by the SOLAR DECATHLON EUROPE competition. The challenge is the following: to develop ideas for constructing



“nearly zero-energy”, low-cost and nonetheless efficient social housing, and to apply those ideas to a green district in Madrid. The project is supported by the Empresa Municipal de Vivienda y Suelo, the housing authority of the Madrid City Council.

This book, which intend to educate and raise social awareness, is also an activity developed within the scope of the SOLAR DECATHLON EUROPE and the 10ACTION projects.

SOLAR DECATHLON EUROPE 2012 COMPETITION

So far, twenty teams from fifteen countries and four continents (Spain, Germany, France, Italy, Portugal, Denmark, Holland, England, Norway, Romania, Hungary, Brazil, Egypt, China and Japan) already committed themselves into participating in the next edition of the SOLAR DECATHLON EUROPE, which will be held in Madrid in September 2012. The Villa Solar will be located at the Casa de Campo. Significant new challenges are foreseen, namely the fact that the electric car and the “smart grid” will be included in the Villa Solar. Citizens will be able to witness the ways in which an intelligent management of energy can be achieved at three different levels of control: the national power grid, the smart grid, and demand management of houses.

COMMUNICATIONS AWARD IN THE SUSTAINABLE ENERGY EUROPE AWARDS COMPETITION

On April 12th, 2011, the European Energy Commissioner, Mr. Ottinger, announced that the SOLAR DECATHLON EUROPE has won, out of more than 300 European initiatives, the Communications Award of the SUSTAINABLE ENERGY EUROPE AWARDS COMPETITION.

I would like to finish this brief introduction by sharing this award with teams from the SOLAR DECATHLON EUROPE and the 10ACTION projects, with institutional partners (Madrid City Council, IDAE, U.S. Department of Energy), and with sponsors (Saint Gobain, Schneider Electric, Kommerling, Rockwool and FCC) who helped organizing it. Without all of them, we would not have been able to carry most of the activities we have been awarded for. I also would like to thank the media for their support and wide coverage of our activities, as well as of course – last but not least– hundreds of university students who competed and gave their best in building prototypes for the future: their vitality and innovative ideas definitely help making the world a more sustainable place.

I finally would like to thank all the people and institutions who actively participated in the development of this project, and in the activities associated with it. This book is a tribute to all of them.

Overview of SDEurope 2010 Competition

by the juries



Architecture
Solar Systems
Engineering and Construction
Sustainability
Communication and Social Awareness
Industrialization and Market Viability

SPEECH AT THE ARCHITECTURE CONTEST AWARD CEREMONY

Glenn Murcutt

Member of the Architecture Jury of Solar Decathlon Europe.

Founding president of the Australian Architecture Association. Awarded the Alvar Aalto Medal in 1992, the Pritzker Prize in 2002 and the AIA Gold Medal in 2009.

The Architecture Jury of Solar Decathlon Europe 2010 was composed of three members and one coordinator:

*Members of the jury: **Glenn Murcutt, Louisa Hutton, Francisco Mangado***

*Jury coordinator: **Luis Fernández-Galiano Ruíz***

Having been a member of the first Solar Decathlon conducted in Washington D.C. in 2002 I can confirm that the standard of design reached in this Solar Decathlon exceeds the quality achieved in Washington by a large measure. It has been an enormous improvement.

The jury congratulates the Spanish government for having brought the Solar Decathlon to Europe, the American Department of Energy and the Politécnica Madrid as well as Luis Fernández-Galiano who has been totally involved and committed to this event. We also congratulate all of you students and your respective universities for your commitment to the realization of such a high level of excellence in the constructed buildings.

However, there are two issues that emerged during the jury deliberations, which we thought should be addressed so as to improve results even further in the future an I'll mention them broadly.

The competition brief has been modeled on the North American experience where single dwellings are able to be afforded – or were, given this international economic crisis – on single sites, resulting in some very mixed quality suburban developments and often poor environments.

It is the view of the jury that the European Solar Decathlon must address the medium to high density condition in the future of cities. This does not mean that the 2010 Solar Decathlon has not addressed important and immediate issues facing our environment – it does by promoting many innovative elements of technology that can be incorporated in more urban contexts.

Secondly, there appears to be an emphasis on the use of technology in construction to address environmental issues. So, passive consideration has still not been sufficiently addressed such as the orientation of buildings, the simple construction, the incorporation of natural ventilation, the ability of opening up and closing down of a building, much in the way one maximizes the performance of a yacht – or even the way one dresses according to seasonal variations. So less reliance on technological solutions alone and a lot more on working with nature and its seasonal variations, minimizing the use of technological solutions is important.

In writing the next Solar Decathlon Europe brief, consideration should be given to allowing for eaves, awnings, covered areas that extend the possibilities of passive design solutions without the loss of points. Such decision would allow for better, simpler and more economical solutions, resulting in considered relationship between the interior and exterior spaces.

Night visits are, we believe, as important as day visits. As jury we very much hope that all the participants will meet their colleagues from near and far to learn from one another and their built experiments.

Lastly, we wish that the Solar Decathlon Europe 2010 is a catalyst for change in the global environment.

EXCITING SOLAR DESIGNS AT SOLAR DECATHLON EUROPE 2010: BUILDING- INTEGRATED SYSTEMS WERE THE MAIN INNOVATIVE ATTRACTIONS

Willi Ernst

Member of the Solar Systems Jury of Solar Decathlon Europe.

Co – founder of "Biohaus Paderborn". Managing director and main share holder of the PV wholesaler "Biohaus PV Handels GmbH". New technologies and innovations advisor for Centrosolar Group AG.

The Solar Systems Jury of Solar Decathlon Europe 2010 was composed of three members and one coordinator:

*Members of the jury: **Willi Ernst, Marcos Calvo Fernández, Christian Bongartz***

*Jury coordinator: **Estefania Caamaño Martín***

The American team from Virginia Tech was the runaway winner of the Solar Decathlon Europe 2010. Their prototype, Lumenhaus, obtained 811.8 points out of a possibility of 1,000. Interestingly, the Americans emphasized quantity over quality in the solar systems category. The criteria of the competition did not promote new, innovative approaches, the jury favoring projects that reached or exceeded the stipulated energy production targets (the consumption of the prototypes during the competition week, plus x percent). In other words: the higher the kWh, the higher the marks. Consequently, the Virginia team, who has learned from previous competitions, used its more than ample financial resources to create a PV field from bifacial SANYO HIT double modules covering the entire roof (a total of about 10 kWp). When slightly tilted, this roof could generate significantly more surplus energy than required. The decision to opt for this technology was a good one, especially given the high temperatures in Madrid and the resulting positive temperature coefficients. The technology was also able to generate an additional energy surplus of up to 25% compared to other modules that use the same cell technology (monocrystalline cells with an additional amorphous layer), as the modules were capable of producing energy on their rear side under favourable conditions - namely the highly reflective roof covering. This meant that the glass-glass modules, which were installed over the north entrance, were less about generating energy (they were not even connected for some time) and more about achieving points for architecture and design.

Like a number of other teams, Virginia had no qualms in relinquishing thermal collectors in favour of using the PV current to heat water with a heat pump. "This is very clever in terms of the competition. Firstly, we are using the available surface area more efficiently by using PV modules to generate more kilowatt hours than collectors would have, which means more points. Secondly, the warm water we are generating is simply a waste product of the active cooling process, which we would require anyway," said the students, now more savvy than ever having taken part in two Solar Decathlons. Almost two thirds of the teams subscribed to this type of thinking. The majority of the other teams, who generated the required warm water with traditional collectors, installed their collectors inside the facade. "This way, the collectors become part of the design of the exterior wall, while also being multifunctional. Of course, they generate the most energy here in winter, which can then be used for heating," explained the teams.

The team from Bordeaux took another approach entirely. Cooperating with a start-up company, the French team designed a tracking concentrator module, which uses monocrystalline, high-performance cells manufactured by the UK company NAREC. The special contact used means that the cells are more concentrated and therefore significantly more efficient at absorbing solar energy. Because they are more concentrated, the cells become extremely hot but are maintained at an acceptable temperature (in this case, approximately 70°) using brine, which flows through a cooling element located behind the cells. According to the students, the size of the receiver was based on the expected warm water requirements in Bordeaux, but the receiver can also cope with the electricity requirements there in summer. In order to ensure the house generated sufficient power to meet the competition targets, the students installed 3.15 kWp Sunpower modules over the south veranda. To counteract the excessive temperatures of the Madrid climate, the students wrote their own computer-supported rule logic, which was capable of adjusting the receiver as desired to get the best from the heat or to offset the heat using a roof-mounted radiator.

The positioning of the parabolic receiver on concrete spoked wheels was cleverly designed but also architecturally risky. The wheels can be rolled backwards and forwards by a single actuator and do not have to be fixed to the building thanks to their own weight. The Bordeaux team received the Innovation Prize from the Solar Jury for their overall concept and for executing and presenting it "with knowledge and passion". They also came third in the Solar Systems category with 52.2 points.

A German project won the Solar Systems category with 55 out of 60 possible points: the Berlin house Living Equia. The team, comprised of students from several Berlin universities (HTW, Beuth Hochschule für Technik, UdK), gave their entire building a black exterior (it was nicknamed the "Casa Negra") and were the only ones who used a sloping roof. Well-ventilated, frameless modules were embedded into the roof and, while not technically innovative, the tilted roof and ventilation they used meant that these modules were optimal for solar technology. The team also chose well when it came to the appearance and positioning of the facade collectors as functional wall elements, and they efficiently integrated the thermal energy into the ventilation and heating system of the house. Two unique features gave the Berlin house an edge over the competition: the south windows were fitted with collapsible, semi-transparent shutters, which featured embedded crystalline cells in the latest plastic modules from Sunovation. On the north roof, plate elements - which again were black and the same size as the modules - ensured that the stored water was cooled during the night and then redirected to the heat pump.

The third place for the overall competition as well as second place for the solar systems category (with 53.7 points) went to the HFT Stuttgart team, from Germany. The students were solely responsible for the extremely professional design and presentation of their solar systems. Their home* design was the most eye-catching project in Madrid, with special glass-glass modules covering the entire facade with coloured Sunways cells. The colour of the cells moves from silver to gold to brown, getting darker as it approaches the roof, in order to blend into the black of the Sunpower cells installed in the middle of the roof. The rear side of these cells is equipped with cooling elements as genuine PV/T modules, which were developed by the students themselves and that, so they say, are market-ready. These modules increase the efficiency of electricity and thermal heat energy production. Solar chimneys, already in use for centuries in the Arab world, were a technological highlight in Madrid. These chimneys circulate warm air using cell-like aluminium plates, which suck in fresh air and spread it over moist cloths to cool it down. A Moorish cooling system at its best!

The German team from Bergische Universität Wuppertal ranked eighth, with 45 points. The distinctive feature of their house was its coating with a special mesh, which drastically reduced the solar radiation in and around the house, which in turn reduced the amount of energy required for cooling. The solar showstopper was the front facade of the house with its square PV modules, as well as the evacuated tubes, which were installed behind a small reflective pond, on an exterior wall bordering the veranda.

The experts were thoroughly impressed by the thin-layer facade used by the CEU Herrera University team from Seville, Spain - who ranked fourth in the solar systems category, with 48 points. Small, long formations of a glass-

based a-Si module are embedded into a prepared plastic facade in such a way that an inverter-compatible string is created, with each row connected from top to bottom. This concept, which could finally lead to the development of a modular system for PV facades using the right technology, can be adapted to suit facades of all heights and widths in a modular manner without one-off production.

The use of modern CIGS tube modules from Solyndra by the University of Florida was also impressive (seventh place with 45.3 points). While this has a certain architectural appeal, the modules did not generate the energy returns the American students expected for reflective flat roofs.

On the other hand, the students from Valladolid, Spain (eleventh place with 42.8 points), made a clever choice in regard to solar engineering. They skillfully installed Centrosolar modules parallel to the roof, so they could be fully rear-ventilated, meaning that upwards-flowing air can be used to heat rooms during the winter. This was essentially a smarter version of a PV/T system, but it proved to be just as effective as an air collector. However, using solar roof tiles instead - which Centrosolar has successfully been manufacturing and selling for years - would have increased these effects even further, as well as producing a tri-functional water-distributing panel with power, heat generation and roof cladding all in one.

Markets that are neglected or underdeveloped with regard to solar technology were shown to entail knowledge deficits regarding the finer points of solar technology. This was especially evident in the self-shading modules of the bamboo house created by the Tongji University team (tenth place with 44 points), the incomplete collector installation in the building created by the University of Nottingham team (who also came last in the solar systems category), as well as the special design of the collector system by the Finnish students from Helsinki (ninth place with 44.8 points). The Finnish team had designed their collector surface to accommodate the lower sunlight levels of Scandinavia and tried to prevent the collectors from overheating in sunny Madrid by eventually placing an awning over them for protection.

In the solar systems category, the house designed by the Institute for Advanced Architecture of Catalonia from Barcelona really turned heads. This plywood house on stilts (nicknamed "Gusano the worm" in Madrid) was fitted with hemispherical plastic collectors with ribbed piping on their interior and featured Sunpower cells on metal panels with Tefzel. As the students noted proudly, this allowed high-performance modules to be adapted to suit the round shape of the building, while being flexibly installed using a standard DIY power drill. Yet unfortunately, because of the resulting lack of durability of the modules, the IAA landed in the fifteenth place, with 40.6 points.

All in all, Spain was a good choice for the Solar Decathlon venue. Its industry and especially politics still have a long way to go in terms of promoting solar technology. The Spanish people themselves, however, showed a great interest in the topic and were keen to learn. During the few days of the Solar Decathlon, 190,000 visitors of all ages attended, from Madrid as well as from all over the world. The future is looking bright!

ENGINEERING AND CONSTRUCTION IN THE 21ST CENTURY CONTEXT: MORE FOR LESS

Dejan Mumovic

Member of the Engineering and Construction Jury of Solar Decathlon Europe.

Lecturer in Environmental Design and Engineering at The Bartlett School of Graduate Studies, University College London (UCL). Member of the 'Complex Built Environment Systems' research group. Co-editor and author of the book 'A Handbook of Sustainable Building Design and Engineering - An Integrated Approach to Energy, Health and Operational Performance'.

The Engineering and Construction Jury of Solar Decathlon Europe 2010 was composed of three members and one coordinator:

*Members of the jury: **Chris Twinn, Dejan Mumovic, Rafael Úrculo***

*Jury coordinator: **Ramón Rodríguez Cabezón***

As all other buildings dwellings are complex, dynamic, socio-technical systems seeking to provide solutions for a multitude of either poorly defined or conflicting design issues. In urban settings, where most of the world population lives, the complex interaction between energy consumption, ventilation, thermal comfort and acoustics presents considerable challenge for designers. Therefore, the process of designing sustainable dwellings is essentially iterative and progressive; this requires close collaboration between architects, building service and construction engineers, and ideally should take into account views of end users (if known). Delivering more for less was the major assessment criteria for the members of the engineering and construction jury, and therefore we were looking for the evidence of processes and techniques which might enable design teams to do so. The criteria were as follows:

- Iterative and progressive design including critical analysis of energy flows and microclimate
- Sound fabric design with respect to heat gains/losses, thermal mass, thermal bridging and airtightness
- Provision of appropriate services including integration of active and passive building systems
- Proper selection of control systems and operational programmes focusing on intuitive use
- Advances in use of passive design solutions

The "more for less" approach is not based only on parameters related to embedded carbon emission and operational energy performance. Members of the jury believed that a sound building engineering design has to appreciate that:

- The built environment is fundamental to the occupants' sense of well-being, productivity and performance.
- The adaptability of design improves the capacity of buildings - over time technologies and practices co-evolve, with householders choosing new technologies from the options they perceive attractive and available.
- Evidence based decision making process leads to reduction of discrepancies between 'as designed' and 'in use' performance of buildings.

Members of the jury especially valued evidence of team working and evolution of initial design ideas. The jury was undivided in thinking that the team from Stuttgart University of Applied Sciences showed a strong evidence of forward thinking and on-going 'in house' research by integrating cooling based on PCM and wind towers with evaporative draught cooling addressing the issues of minimisation of associated health risks and integration of air distribution into architectural design of the house.

Furthermore, the jury strongly believed that sustainable building services must not be considered as an independent part of the building but need to be integrated into the building design. Innovation should be always encouraged, but a sound approach to building design requires technically feasible solutions, justified in terms of costs, acceptable from the environmental and social standpoints, and ensuring the high level of living standard and comfort. Solutions offered by Arts et Métiers Paris Tech such as integration of thermal mass into relatively lightweight construction or ventilative skin behind earth clay panels and an interesting prototype of shading system (which addresses a design

conflict between solar control and use of natural ventilation) designed by Ecole Nationale Supérieure d'Architecture de Grenoble were judged to be good examples of integrated building design.

Last but not least engineering and construction in the 21st century context has to address the issues of rapidly diminishing natural resources. The major challenge is to engineer for high urban density social housing. Nottingham's University house was judged to be a realistic example of sustainable social housing based on passive evaporative draught cooling which could be delivered en masse by construction industry. In this direction, École Nationale Supérieure d'Architecture de Grenoble carried out a feasibility study aimed to analyse how their design could be applied to provide a high density urban development.

Overall, members of the engineering and construction jury have been impressed with the energy, drive and growing expertise of future professionals. They have done well indeed. Solar Decathlon proved to be a knowledge exchange forum which brought together enthusiastic future professionals from all around the world, their supervisors and industrial collaborators with a range of necessary expertise including building design, engineering, construction and project management. The members of the engineering and construction jury have been impressed with the energy, drive and growing expertise of future professionals. They have done well indeed.

SOLAR DECATHLON 2010 AFTERTHOUGHTS

Felipe Pich-Aguilera Baurier

Member of the Sustainability Jury of Solar Decathlon Europe.

President of GBC Spain. Founding member of ASFE (Asociación de Arquitectos sin Fronteras) of the ESARQ/

UIC (School of Architecture of the International University of Catalonia), and of the Agrupación Arquitectura y

Sostenibilidad del Colegio de Arquitectos de Cataluña (Group for Architecture and Sustainability of the College of Architects of Catalonia).

The Sustainability Jury of Solar Decathlon Europe 2010 was composed of three members and one coordinator:

*Members of the jury: **Fiona Cousins, Chrisna du Plessis, Felipe Pich-Aguilera***

*Jury coordinator: **Beatriz Rivela Carballal***

After visiting the prototypes of the Solar Decathlon Europe 2010 and carefully looking into the strategies, the systems and the materials used for each house, I was convinced that aiming at an environmentally sustainable way of building is not just an empty concept or an alternative option anymore. The underlying ideas of the prototypes were not just good intentions, but a catalogue of actual, practicable solutions leading towards, in many cases, concrete market applications.

It is obvious that the people who visited the Villa Solar found the prototypes really interesting. I am not just talking about experts, but especially about ordinary people who massively attended Villa Solar during the whole week –something exceptional in itself for an exhibition about building and architecture. This social interest was one of the most relevant aspects of the competition, since it allowed a wide audience to witness the fact that energy self-sufficiency is possible in daily life. Beyond abstract approaches, it showed to the broadest public that architecture is ready to merge with technology, offering specific, operative solutions.

The Solar Decathlon showcased some of the strategies and of the main trends that are being developed in the field today. It suggested far-reaching solutions for the future – some of which, though, might imply some contradictions.

There is some latent duality between architecture and machines from an environmental point of view. On the one hand, some consider the building as an instrument achieving adequate climate and habitability conditions. On the other hand, some consider its potentiality to integrate very efficient mechanisms in terms of consumption and environmental impact. In a way, these two approaches represent two “extremes”, or two different paths that may be followed, the first one being prevalent in warm climate cultures, and the other one in cold climate cultures.

In spite of that, all the prototypes clearly demonstrated (to a greater or lesser extent) a focus on passive approaches, based on strategies linked to the inherent design of the houses. At the same time, they included active technologies such as machinery and other elements. What made a difference was the way both strategies were combined. However diversified in terms of options and architecture, the projects were somewhat eclectic: we could hardly draw a “model” or a type out of it –which would, say, reflect the “paradigm of today”. To that respect, maybe more “radical” research programs are needed. I am not saying that the exhibition didn’t featured very good architecture, yet I remark that designs still owed a lot to the conventions of the modern tradition. That said, I would like to highlight evident achievements in regard to systems integration, i.e. regarding the sensitiveness and creativity deployed in “turning into architecture” some systems that could otherwise have stayed simple gadgets and protuberances, as for example the PV parameters of the Stuttgart team.

Yet, the prototypes did show some common features: teams generally shared some technology or approaches they all considered essential to their design. The use of the thermal inertia of the materials as a heat storing and interior conditioning element is a good example. Since we are talking about light constructions, almost all the envelopes of

the prototypes also integrated phase change materials, to give some inertia to thin laminar systems.

Another commonality (somehow implicit in the dynamic of the competition) was a conception of the construction as a dry assembly of components. This underlies a reflection on the necessary "manufacturing" of the elements, their disconnection from the place where the house is located, its eventual industrial logic, its recycling, and so on. Such a conception of architecture, industrialized in some way, was present in all the prototypes, even if they of course featured different approaches ranging from "low-tech" reinterpretations of systems and traditional materials (like the prototype of Tianjin University) to intricate "high-tech" strategy of complementary skins (like the prototype of Virginia University).

The exhibition suggested a contrast between two general philosophies. On the one hand, those who think that the right thing to do is a "progressive evolution": improving standard constructions, based on what "society is used to". On the other hand, those who, on the contrary, believe that we need to take things as far as possible in order to produce excellent references which can widen the whole sector. Without underestimating the effort and effectiveness of the first one, I personally am in favor of the second option. From my point of view, especially since the media are so important nowadays, it is the most appropriate strategy to stimulate innovation and research. It is the only way we will witness the development of a new architecture.

I would like to conclude in earnestly congratulating the institutions which have planned and organized this event, as well as the industries which have been involved in it, and, most of all, the large team which made all this possible. All together, they proved that innovation can arouse social interest - precisely thanks to the shared complicity and the effort they both enact and promote. I hope that our sector takes good note of this.

CATALYST FOR CHANGE: THE SOLAR DECATHLON MAKES ITS DEBUT OVERSEAS

Jane Kolleeny

*Member of the Communication and Social Awareness Jury of Solar Decathlon Europe.
Senior editor in Architectural Record magazine. Managing Editor of GreenSource:
The Magazine of Sustainable Design.*

The Communication and Social Awareness Jury of Solar Decathlon Europe 2010 was composed of three members and one coordinator:

*Members of the jury: **Jane Kolleeny, Javier Gregori, Miguel Ángel Valladares***

*Jury coordinator: **Beatriz Arranz Arranz***

After five U.S.-based competitions, the Solar Decathlon went to Madrid in June 2010 through an agreement between the U.S. government and the Spanish government's Ministry of Housing. Seventeen solar-powered residences were assembled on a stretch of land lining the Manzanares River, west of the Royal Palace in Spain's capital city. Students from universities around the world raised funds for the projects, and conceived, designed, built, and marketed them. The Solar Decathlon serves as a learning lab, where students are judged in ten categories, challenging them to think holistically about design. Among the areas ranked are architecture, engineering, energy performance, communications, and market viability. Some of the categories are performance-based and ranked by measurement, others by jury. Next year, the competition will add affordability to the mix.

This internationally known competition began in the U.S. in 2002, the brainchild of the Department of Energy's Richard King. He was frustrated at the slow deployment of solar technologies and sought means to educate consumers and aspiring students about them. King, who has watched the program grow from its infancy, says its beauty lies in "[...] its iterative progression. The teams come together and learn from each other what is successful. Then, the new generation of teams takes these lessons, goes back to the drawing board, and tries to create better homes," King explains.

In the inaugural year, fourteen teams from the U.S. and Puerto Rico competed, their houses occupying the National Mall in Washington, D.C. In 2010, seventeen competing teams came from all over the world, including two from China, two from the U.S. and two from France; three from Germany; one from Finland and one from the U.K.; finally five from Spain, marking a transition in the program to global participation.

This past year in Madrid, Pritzker prize-winning architect Glenn Murcutt joined other architectural jurors—Louisa Hutton from Berlin-based Sauerbruch Hutton, Pamplona-based architect Francisco Mangado, and Luis Fernández-Galiano from the magazine *Arquitectura Viva*. Murcutt was on the original jury for the first decathlon, so it was an apt opportunity for him to revisit the program and acknowledge the tremendous progress it has made since 2002. This year, the architecture jury recommended that future competitions address the density of cities. They also emphasized natural ventilation, "allowing for eaves, awnings, and covered areas that extend the possibility of passive design solutions without the loss of points," explained Murcutt in his remarks at the competition.

The architecture jury also felt the weightings of the ten categories needed adjustment, feeling that architecture needed to trump the other categories. With this in mind, they premiated multiple winners in the architecture category to assure that design weighted more significantly than the other measurements. While their strategy does not necessarily solve the problem, the topic should be debated by the organizers from opposing standpoints to come up with a viable solution.

I served on the media jury. It was a unique and interesting challenge for me. As a journalist with both a communications and green design background, I found it hard to single out the success of communication from a project's other strengths or weaknesses in the area of architectural design. Acknowledging that aesthetics plays an important role in communication, that it conveys the overall sensibility of a project, it seems that aesthetics is the first and most overall impression a project makes. So, in hindsight, my background was in fact well-suited!

I was joined on the media jury by Miguel Angel Valladares, who has served since 1998 as the Director of Communications of the World Wildlife Fund in Spain. He has a robust background in journalism and book publications, and has lectured and been interviewed extensively in his role. In addition, Javier Gregori, a radio journalist from 1993 to 2007 for a radio show called "The Green Hour" focused on the environment, now teaches scientific journalism at the Universidad Carlos III de Madrid, and lectures and publishes extensively on the environment. Our jury was able to come to agreement with ease regarding our evaluations of the projects, although language was sometimes a barrier.

Among the tools we used to evaluate projects in the communications category were website, branding and project name, technology tools and applications, communication of the student team, the building tour, the displays of the project, the videos, the communications plan, brochures or collateral materials, and, finally of course, the built projects themselves. The overall design of each project was perhaps the most visible communications vehicle for the competition.

Our winner in the media category was the Refocus House by the University of Florida. The jury felt the articulation of the communication plan was unrivaled. We loved the branding of the Refocus house idea, which was conveyed in all ten categories of the decathlon. The project linked seamlessly to the navigation and usability of their website, and a series of buttons and brochures strengthened their concept. We loved their guerrilla marketing strategy, and their "make a change, not a footprint" campaign. The modern interpretation of the traditional southern-style Cracker house was aesthetically superior we felt.

Inspired by the Farnsworth house, Virginia Tech's Lumenhaus took top honors in the sum of all categories in Madrid. This was the team's first big win after participating in the competition in 2002, 2005, and 2009. Lumenhaus was among the top contenders in the communications category as well. We loved the name and the slogan "a brighter day every day". The project utilizes smart technology including an I-Phone application that allowed the house to be powered from off-site locations. We also appreciated the design of the house altogether, including the graceful metal screen facade.

The Refocus house team included a group of marketing students who were solely concerned with communications on behalf of their team. This worked to their advantage. We wondered if other teams were so fortunate to have such resources—I doubt it. We noted that some of the non-winning projects websites were only in German or Spanish, many teams had little or no communications plan, and a variety of other weaknesses. In general we felt there was an inequality in resources available to the teams, i.e., with additional resources some of the teams could have done much better.

In October 2011 the Solar Decathlon will once again convene in Washington D.C.. The U.S. competition will include newcomers from the U.S., as well as Hawaii, New Zealand, and Belgium. Spain will continue to host the competition in alternate years convening again in 2012, where universities from all over the world have presented their proposals. Currently, 33 out of 47 teams are set to compete in 2012 in Madrid, the majority are from Europe, from America, Africa and Asia. See you there I hope!

INDUSTRIALIZATION AND MARKET VIABILITY JURY EVALUATIONS

Pablo Jiménez

Coordinator of the Industrialization and Market Viability Jury of Solar Decathlon Europe 2010.

Architect. Sustainability Coordinator, TYPSA Group.

The Industrialization and Market Viability Jury of Solar Decathlon Europe 2010 was composed of three members and one coordinator:

*Members of the jury: **Senta Morioka, Luis Basagoiti, Garry Palmer***

*Jury coordinator: **Pablo Jimenez García***

The Industrialization and Market Viability Jury assesses the viability of the housing model in analyzing three key aspects:

- Commercial and economic viability. A potential market is identified and explained: the prototype must attract future inhabitants and property developers.
- Industrialization of the construction process. The design is evaluated regarding its eventual mass production, focusing on three different volumes of production.
- Flexibility and re-arrangement. The capacity of possibly generating different urban models is examined.

The Solar Decathlon Europe 2010 assembled a multidisciplinary jury of highly specialized experts in the field. Senta Morioka is the president of Toyota Housing Inc. He has been leading Toyota's Housing Division since 1996, where prefab houses are designed, built and delivered. Luis Basagoiti is specialized in structures and light industrial prefabricated buildings. Garry Palmer founded AECOM Advanced Design Group and his interest in the Solar Decathlon is based on the question of how architecture, performance, flexibility and materials all together influence the viability of innovative residential architecture when applied to city scale master planning, within differential contexts and geographies.

The jury studied the documentation provided by the participants about their project at different stages of the competition. Complete documentation was sent to the jury one month and a half before the actual contest. Amongst this documentation, the Industrialization and Market Viability Report prepared by the teams is worth mentioning: each team had to concisely explain the industrialization, construction and assembly process of their prototype. They provided an analysis of the production and construction costs, based on which economic/market viability studies could be conducted. They also presented, graphically, different possible arrangements for their prototype. Jury members all remarked how useful these reports were in completing their evaluation. The crucial part of the competition took place at the Villa solar on June 19th and 20th. Jury members spent two days visiting, one by one, the seventeen houses that had reached the final stage of the contest. According to Solar Decathlon's rules, they followed a detailed procedure: twenty minutes was allowed for the overall presentation, and for related questions/answers, after what the jury was given ten minutes to gather and deliberate in private. While moving from one prototype to the other, the jury had an extra ten minutes for a brief exchange and for greeting the teams; this time also allowed them to get a general impression of the outside while approaching the following house. In a spirit of respect and fairness, the schedule was scrupulously observed by both by the teams and the jury.

In a highly professional atmosphere -lightly peppered with the typical nerves felt at such important events-, the students presented the result of two years of brilliant research, hard work and effort to the jury. All well-aware of how important this final stage of the competition was, the students showed thoroughly prepared: they rightfully illustrated the concepts of their projects and presented them in a neat and methodical fashion. They briefly, consistently translated their ideas into words, pictures and sounds, with the support of every technical or technological means available -some of which are already on the market, some of which have not been commercialized yet.

On 20th June, after two intense and exhausting days of touring, the jury gathered in what can be considered a privileged space: the very house that represented the UPM (Polytechnic University of Madrid) and the whole Spain

at the 2007 edition of the Solar Decathlon. They deliberated for more than four hours. Jury members brought their notes to the table; they all presented a general evaluation, and also shared a personal assessment of each of the teams. After these individual presentations, the jury discussed and then voted for a ranking of the projects, according to the rules and criteria of the competition. The final ranking was very tight – a proof of the high quality of some of these projects in their conceptual, technical as well as professional aspects.

The jury was finally asked to provide a report summing up the strengths and weaknesses of the projects, identifying aspects that could be improved in each of them. This way, experiences and lessons from every team could be put together and gathered in a useful way, leading towards the future of research, development and innovation in the field of industrialization applied to sustainability and energy efficient architecture.

Approach to SDEurope 2010 Houses Innovation

by Institute for the Diversification and Saving of Energy



*Insulation
Solar Protection Devices
Thermal Storage
Heating and Cooling Systems
Solar Systems*

Fortunately, the use of insulation in opaque components of the building envelope (walls, roofs, etc.) is something common, as well as obligatory, in the legislation concerning buildings in most of developed countries. Nevertheless, competitions like the Solar Decathlon Europe 2010 act as a test laboratory to use innovative materials before they become widely used on the market.

Even nowadays, most commonly used insulation materials are non-biodegradable, and hardly recyclable. Many of the solutions proposed within the context of the last edition of Solar Decathlon were based on the use of environmentally friendly materials (see figure 1). Their thermal properties may not be as spectacular as some of the most well-known insulation materials. Nevertheless, they doubtlessly have a much lower impact on the environment. For example, some of the projects presented in this book, such as the Arts et Métiers Paris Tech house, used wood or newspaper fibers as new solutions.

Another solution proposed by some of the competing universities was vacuum panels (see figure 2). Their energy features are very good: they achieve very low thermal transmittance values with really thin profiles, due to the extremely good conductivity values (about $0.005 \text{ W} / \text{m}^2\text{K}$). Teams from the Bergische Universität Wuppertal and the Tongji University are good examples.

These vacuum panels consist of a reflective coating that prevents the gas inside, surrounding the nucleus, to flow through: the vacuum is made in the nucleus where the insulation material is located. When the air is eliminated from the hollows of the insulation material, the thermal features of the material are remarkably improved.

Panels of this kind feature:

- Coating preventing the passage of air into the vacuum area.
- A nucleus in the inside of which vacuum is made, and which provides structural stiffness to the whole as well. The most widely used materials are aerogels (a very low-density solid), glass fibers or foams.
- Chemical products that capture the gases that may be filtered through the coating, so as to maintain the absolute pressure of the nucleus pores under 1 mbar.

Aerogels (see figure 3) can also be used as primary material to compose a translucent insulation "sandwich". Such a solution has been proposed by the Virginia Polytechnic Institute & State University. Insulation panels are made of double layer translucent polycarbonate systems filled with the aerogel.

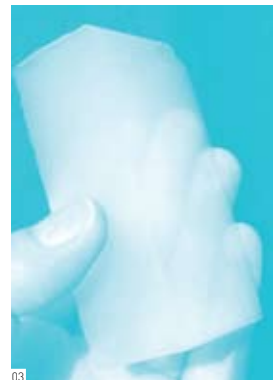
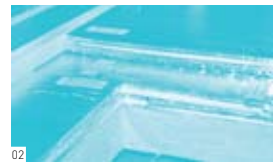

Fig 1: Thermal Insulation composed of cotton fibers
Source: Green Home Authority, USA
Fig.2: Vacuum panel
Source: International Starch Institute, Denmark
Fig 3: Aerogel

SOLAR PROTECTION DEVICES

Solar protection devices prevent the excess of gains derived from solar radiation falling on the hollows of the building envelope. Moreover, if these devices are endowed with the appropriate geometric shape, or with a well-designed control system, gains can be achieved in the wintertime, when they are necessary to reduce the heating charge in the building. On the contrary, solar gains will be avoided in the summertime when they are not necessary, as they will demand greater energy consumption devoted to cooling.

For all the houses taking part in the Solar Decathlon Europe, architectural design took into account an appropriate exploitation of solar gains. For example, the winning house, by the Virginia Polytechnic Institute & State University, uses a series of mobile devices (see figure 4), enabling the exploitation or avoiding solar gains depending on the indoor activity and the outside climate conditions.

The University of Applied Sciences Rosenheim (see figure 5), used solar protection based on zig-zag panels, which apart from allowing the control of solar radiation entering the house, contribute to its very interesting architectural design.

Moreover, similar devices, as in the example of the University of Florida, allow the integration of PV systems to generate electric power (see the solar system section).

Solar protection devices can contribute to the high-quality design of windows and glass roofs. The project of the Stuttgart University of Applied Sciences provides a good example (see figure 6, 7).



Fig. 4: LUMENHAUS, Virginia Polytechnic Institute & State University
Fig 5: IKAROS, University of Applied Sciences Rosenheim
Fig. 6,7: Interiors of HOME+ and skylight, Stuttgart University of Applied Sciences

THERMAL STORAGE

The aim of thermal energy storage is the reduction of demand peaks in a building by taking advantage of its own mass, or making use of the so-called phase change materials (PCM).

The exchanged heat between a body and the surrounding environment responds to this equation: $Q = m \cdot c_p \cdot \Delta T$ where Q represents the amount of exchanged heat; m , the body mass; c_p , its specific heat under constant pressure, and ΔT , the temperature variation undergone by the body.

Therefore, to store a remarkable amount of energy into a material which does not change phases, it is necessary to use a large amount of mass as the increase or decrease in temperature the building can use will not be that high, due to its physical and use limitations. Its specific heat will also be established depending on the kind of materials typically used for building. It is the very structure of the building that is used (usually concrete, and therefore, massive). The techniques used vary, ranging from the simple use of faced forging to forced circulation of night air through the hollows of honeycomb forging. Solutions of the kind have been used by the Virginia Polytechnic Institute & State University.

Should the said body change phases, the equation in question will be: $Q = m \cdot L$ where L represents the latent heat of the body. Phase change materials take advantage of this heat, which is, in the case of some materials, comparatively much higher than the specific heat under constant pressure. In the case of water, fusion latent heat (change from solid to liquid) is 334 kJ / kg versus the 4.16 kJ / kg·K specific heat at constant temperature. This is the reason why in order to cool a drink, it is much more profitable to make use of ice than of the same amount of liquid water at the same temperature.

Phase change materials take advantage of this effect. In order to choose them, it is necessary to look for materials whose fusion / solidification takes place within the appropriate temperature rank. For example, ice has been used for years to store energy in large heating and cooling installations. These phase change materials are used by universities such as Universidad de Sevilla or the Arts et Métiers Paris Tech (see figure 8).

They can be used to store energy during a period of time where the temperature is low enough to solidify the material (at night), and then used to cool the building during the hottest hours. Bergische Universität Wuppertal uses them to reduce the peak loads by preheating the exterior air before having this air flow through a heat exchanger. This preheating effect is achieved by blowing the air through a device containing the phase changing materials that were solidified during the night.



Fig. 8: PCM heat exchanger, Arts et Métiers Paris Tech

HEATING AND COOLING SYSTEMS

Houses make use of a large variety of different heating and cooling systems - only some of them are stated in this document. The reader is referred to detailed information provided with the description of the projects taking part in the contest to get more information on the specific systems used.

Some make use of evaporative cooling, as for example the University of Nottingham (see figure 9) or the Universidad Politécnica de Cataluña. Evaporative cooling consists in the use of water, which is sprayed onto the outdoor airflow to be introduced into the house: this water evaporates, and reduces the impulsion air temperature. This colder air is then lead into the needed areas, either by means of mechanic systems (which is usually done in conventional buildings) or with passive systems taking advantage of the natural tendency for cold air to go down as a result of its higher density (as compared to hot air).

The University of Nottingham has made use of this effect by means of air diffusers placed at an opening of the roof house. They used passive systems so as not to have to resort to air intakes by way of the traditional system of fans and ducts.

The Universidad de Valladolid has used the same evaporative cooling concept (see figure 10), but they used a device that moistens the air taken into the house, the way a botijo (earthen jug) works (a traditional small ceramic container enabling to keep the water cool): the university staff resorted to the porosity of pottery which, this way, gets the air in touch with the evaporating water, and therefore cools the whole.

The Universidad de Sevilla made use of solar chimneys (see figure 11) to favour natural airing in the building, and to reduce its thermal charges. Hot solar radiation heats the roof which heats the air below it. This air goes outside through natural means, giving place to a depression making air come into the house without using mechanical means to do so. Exterior air enters the house through the chimneys, which include an evaporative cooling system to chill it.



Fig. 9: Evaporative cooling system, University of Nottingham.
Fig. 10: Evaporative heat exchanger, Universidad de Valladolid.
Fig. 11: Showing the solar chimneys Solarkit house, Universidad de Sevilla.
Fig. 12: Flexible PV panels used by the Instituto de Arquitectura Avanzada de Cataluña.
Fig. 13: Concentration system used by Arts et Métiers Paris Tech.
Fig. 14: Integrated PV panels in solar protections used by the University of Florida.
Fig 15: Slim-layer PV-modules integrated in the facade. SMLHouse, Universidad CEU Cardenal Herrera.
Fig. 16: Hemispherical collector by the Instituto de Arquitectura Avanzada de Cataluña.

SOLAR SYSTEMS

The 2010-1031 Directive on Energy Efficiency in Buildings called for “nearly zero energy buildings”. Accordingly, the prototypes of the Solar Decathlon Europe had to mostly self supply their own energy demand. The small amount of energy still demanded should be provided, whenever possible, by renewable energy sources.

Solar Decathlon houses make an extensive use of solar-PV energy, ranging from flexible panels integrated in the building, as in the case of the Instituto de Arquitectura Avanzada de Cataluña (see figure 12), to concentration systems that enable generation of electric power and domestic hot water (DHW), as in the case of the house presented by the Arts et Métiers Paris Tech (see figure 13).

The University of Florida (see figure 14) used tubular photovoltaic modules. Apart from fulfilling a solar protection function, they can be integrated to the facade, while generating electric power.

The Virginia Polytechnic Institute & State University used bi-facial PV-modules which inclination is adjustable. CEU University (see figure 15) used slim-layer PV-modules integrated in the facade.

Some teams also used solar energy to produce domestic hot water (for direct use or for the heating and cooling of the house itself). Some of them came along with very innovative solutions, like the hemispherical collectors proposed by the Instituto de Arquitectura Avanzada de Cataluña (see figure 16), or the thermal concentration panels used by the CEU University.



Text written by:

Marcos González Álvarez

*Project Manager / Building and Households Department
IDAE: Institute for the Diversification and Saving of Energy
Ministry of Industry, Tourism and Trade*

Description of SDEurope 2010 Houses

by the participating universities



Virginia Polytechnic Institute & State University, United States of America

Hochschule Rosenheim University of Applied Sciences, Germany

Hochschule für Technik Stuttgart, Germany

École Nationale Supérieure d'Architecture de Grenoble, France

Aalto University, Helsinki, Finland

Bergische Universität Wuppertal, Germany

Arts et Métiers ParisTech, Bordeaux, France

University of Florida, United States of America

Universidad CEU Cardenal Herrera, Valencia, Spain

Hochschule Berlin University of Applied Science for Technology

and Economics + Beuth Hochschule Berlin University of Applied

Science for Technology + University of Arts Berlin, Germany

Tongji University

Universidad de Sevilla, Spain

Universidad Politécnica de Catalunya, Spain

Universidad de Valladolid, Spain

University of Nottingham, United Kingdom

Tianjin University, China

Instituto de Arquitectura Avanzada de Catalunya, Spain

Universidad Politécnica de Madrid, Spain

LumenHAUS™

Virginia Polytechnic Institute & State University, United States of America

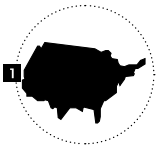

Nº.1 / 811,83 points

Contest 1: Architecture: 120,00 points.

Contest 2: Engineering and Construction: 51,00 points.

Contest 3: Solar Systems and Hot Water: 67,00 points.

Contest 4: Electrical Energy Balance: 114,74 points.

Contest 5: Comfort Conditions: 99,61 points.

Contest 6: Appliances and Functioning: 113,39 points.

Contest 7: Communication and Social Awareness: 68,80 points.

Contest 8: Industrialization and Market Viability: 60,30 points.

Contest 9: Innovation: 42,00 points.

Contest 10: Sustainability: 70,00 points.

Bonus Points and Penalties: 5,00 points.

Introduction and Main Objectives of the Project

The Virginia Tech Solar Decathlon Team is working to provide a model for an energy independent architecture that accommodates active lifestyles of a changing society in a spatially rich environment. A collaborative of students, faculty, and staff from fifteen departments have come together to design, build and operate a unique solar house that demonstrates a comfortable living and working environment, excellence in sustainable construction, and strong architectonic expression. As a pilot fish in design research we want to crack open new ideas regarding residential construction and the use of energy in buildings. This may seem a provocative house for a conservative market, but aspirations are set to Daniel Burnham's polemic: "make no small plans, they fail to stir the hearts of men" (and women).

The mission of the Virginia Tech Solar Decathlon team is to inform and educate the public about issues regarding energy (particularly solar) and sustainability while enhancing student education through a design-build process of innovative research, testing and application.

Our multidisciplinary team strives to achieve the following goals:

- Illustrate how solar energy can improve quality of life through increased energy and access to natural light in residential building.
- Increase public awareness of energy use in daily life by providing an awareness of electrical use, thereby promoting a mandate for conservation.
- Demonstrate that market-ready technologies exist,

and that they can meet the energy requirements of our daily activities by tapping into the sun's power.

- Establish a home that is responsive to its environment and integrates passive heating, cooling and daylighting.
- Demonstrate that sustainable materials and technologies can comprise a beautiful structure in which to live, work, and play.
- Examine a project in a prototypical manner to develop solutions that can be reproduced and realized through manufacturing techniques with economic benefit.
- Challenge conventional architectural practice through interdisciplinary collaboration and corporate partnerships.

Architectural Design

The Virginia Tech LumenHAUS™ is driven by a multidisciplinary approach that challenges research through application. It harnesses the tension created by the dualities of calculation and intuition; technological innovation and architectural expression; optimized performance and sensible materials; and between physical fact and psychic effect. Simultaneous consideration of technology and architectural content has guided the identity of the house. *Every decision involving quantitative criteria was measured in terms of its contribution to spatial quality.*

Issues of energy are often interpreted as primarily technical, comprising data and enhanced by equipment. We subscribe to this mandate and affirm that the calculative world of science and engineering are

indispensable. Yet, we also believe that these efforts in themselves are not sufficient - it ultimately must be beautiful as well as functional.

The architectural concepts that inform our design are as follows:

- A house larger than itself – plan and section orchestrated by light and material to enhance spatial perception of a small footprint and volume.
- A house that responds to changing environmental conditions and user requirements.
- Every technical decision is measured in terms of its contribution to spatial effect.
- Material considered for its technical capacity and architectonic expression.
- The landscape and architecture are one.

Energy efficient and sustainable living is offered in a rich and sensuous environment.

- Marketability and innovation – simultaneous awareness of public taste and the need for something meaningfully different and exciting.

Exterior design. The name LumenHAUSTM and the notion of *living a brighter day everyday* finds expression in a specific architectural type. The house takes the provocative position of a pavilion - an architectural space of distinction unlike most solar powered houses. Where most energy conscious houses are closed with strategic openings to resist heat transfer, our house has flowing spaces linking the inside and the outside. Open on the north and south facades, the house seems much larger than its small footprint. Decks, water features and landscape mesh with the architecture to create a seamless environment of sun and space. Rich and divergent qualities of light fill the house from sunrise to sunset, and sliding panel systems respond to climatic conditions, providing a full range of protection from the elements and a rich architectural experience.

Interior design. The house is composed of a rectangular plan of open and flowing spaces. Mechanical and electrical equipment anchor the west façade; the kitchen is embedded in the east wall. These elements serve as bookends to the plan inflecting the space to the north and south decks. A ribbon window contiguous with the kitchen counter admits afternoon light. Bouncing off the west water pond, the yellow glow of dappled sunlight splashes on the ceiling. The kitchen is a center of activity supporting informal social gatherings and a transformable workspace. Of particular note is a sliding table that nests with the counter to make a second work surface as a galley kitchen, or it can move over the dining table to create a side table, separating the

dining from the living room. The dining table can be rolled in the opposite direction supporting activities on the north or south decks. Cabinets are designed with intricate “fold down – slide out” elements that make a small space more efficient. Similar space-saving design can be found within the bedroom’s storage closets and laundry cabinets.

A central core accommodates storage, bathroom and office areas, playing an important functional and spatial role. As an object in the space rather than an assembly of walls, it separates the living area from the bedroom, allowing a full reading of the volume. It also yields alternate paths on which one can walk through the dwelling.

Construction and Materials

The structure of the house is a rigid steel frame factory assembled to close tolerances. Structural insulated panels (SIPs) comprise the roof and end walls. With high insulation values, these panels also serve as the sheer bracing for the structural frame. Removable diagonal bracing allows for the frame to resist deflection and carry heavy loads. Thus, the house can be transported intact with little site assembly. The detachable gooseneck (connection to cab) and bogey (rear wheel assembly) are prototypes for a distribution strategy for mass produced units.

Eclipsis© system. The house adapts to optimize energy efficiency, and articulates the architectural space differently through combinations of sliding panels. It is designed to be flexible and fluid to a wide range of climactic conditions while accommodating various modes of living. The north and south walls are composed of sliding layers of curtains, glazing, insulating panels, and metal shutters. The two outer layers are part of the *Eclipsis© System*. The outermost layer is a stainless steel sheet metal assembly with a circular geometry of laser-cut holes and folded tabs. It functions as a shutter with a four-fold role, in order to keep the summer sun off the façade; to offer degrees of privacy while maintaining contact to the outside; to break sunlight into fractals that intensify and enrich the space, and to permit cross ventilation. The folded tabs have three variables – the diameter of the circular cut, the orientation of the tab and the degree of tab fold. These variables are articulated to block and bounce sunlight and create views. For example, in the bedroom, the tabs are folded on a vertical axis favoring south-east/north west orientation. This causes the rising sun to strike the backside of the tabs and bounce into the bedroom while

blocking direct views into the space. In the dining room, strategic tabs are fully folded (90°) on a horizontal axis to create a direct view outside from dining height while blocking direct sunlight.

The second layer is an assembly of polycarbonate panels filled with Nanogel (Cabot Chemical's trade name for aerogel). An innovative wall assembly contains light literally and phenomenally. This double wall section gives an R-24 insulation value while transmitting a beautiful translucent light. In this house, there is no need for electric light from sunrise to sunset and the energy collected during the day is symbolically radiated back out at night through the lantern glow of the house. Between the layers of the polycarbonate panels is a three-inch airspace containing banks of LED (light emitting diode) fixtures. The glow of these lights through the polycarbonate reflecting off the water gives the house a unique nighttime identity.

Interior Comfort, HVAC and House Systems

General concepts for sustainable architecture – compact volume, little air infiltration, strategic insulation, natural/cross ventilation, integrated geothermal energy sink and passive heating are articulated with appropriate technologies.

Other features difficult to demonstrate in renderings but critical to the architecture include:

- The concrete floor aids in passive heating and provides a sense of dwelling through its massive presence; the extra weight is balanced by a spatial condition of permanence and security.
- Radiant heating is the highest quality heat -there is no moving air, it is quiet, the heat is located at one's feet and the ambient temperature can be kept lower.
- Translucent polycarbonate panels filled with Nanogel offer high insulating values (R-24) while delivering a beautiful translucent natural light from sunrise to sunset.
- The pavilion characteristics of the house allow for less mechanical heating and cooling throughout the year.
- The landscape is built to demonstrate water conservation techniques through development of a system that integrates the exterior and interior environments inclusive of rainwater harvesting system, constructed wetlands, and hydroponic planting schemes.
- The constructed (hydroponic) wetlands are organized through a modular grid system. A variation of a green roof modular system is utilized as the base for our wetland cells due to the ease in moving and constructing the system. These elements are placed in the three

reflective water basins around the house. The grey-water from primary treatment passes through modular wetland units to naturally remove the nutrients from the water. Floating plants in the reflective ponds further cleanse the grey-water. The ponds are interconnected with back flow prevention and when the water reaches the last pond, it is thoroughly treated and passes through a final UV filter for distribution with the water closet in the house.

Solar System

The 10.5 KW photovoltaic array is reasonably sized to the scale of the installation. It will meet the highest demands of the house while generating additional energy to power an electric vehicle or to return to the grid.

Electric motorized actuators raise and lower the photovoltaic array to track the sun throughout the season. This flexibility allows the house to be located anywhere in the world, since it works with varying sun angles. The PV array features bifacial panels that collect energy from both sides of the glass, producing more power than a typical panel. The all photovoltaic electric system powers a highly energy efficient geothermal heat pump heating, cooling and hot water system. Since hot water is already provided, a thermal hot water system is not needed. More space is thus allocated to photovoltaic, making the house more competitive for the Solar Decathlon contest.





View of different solutions using LumenHAUSTM

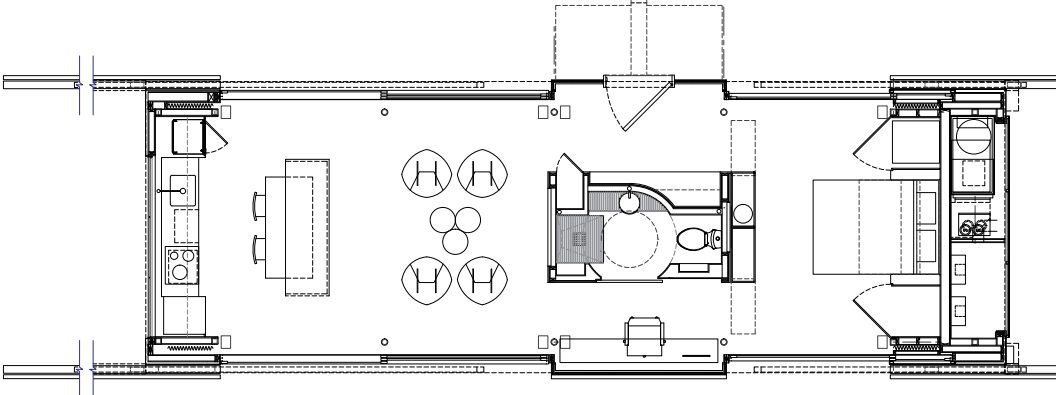

Floor plan

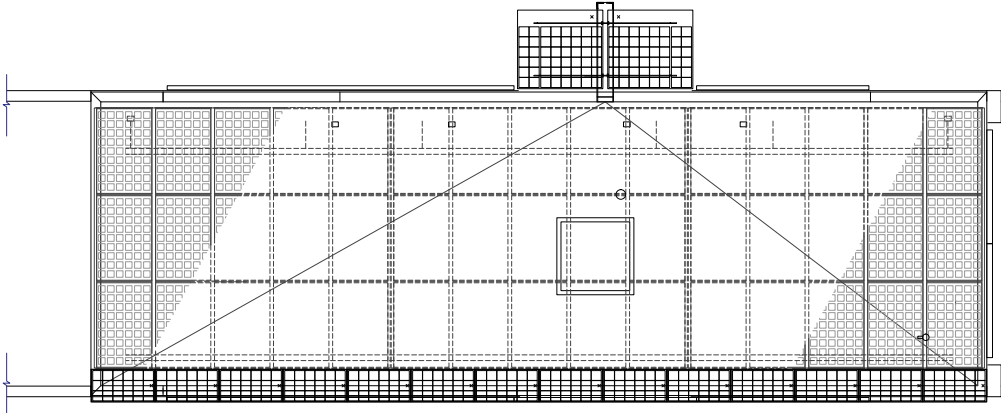

Roof plan

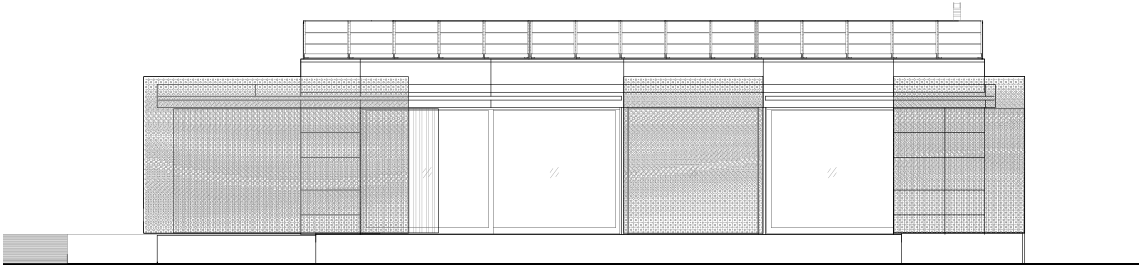

South site elevation

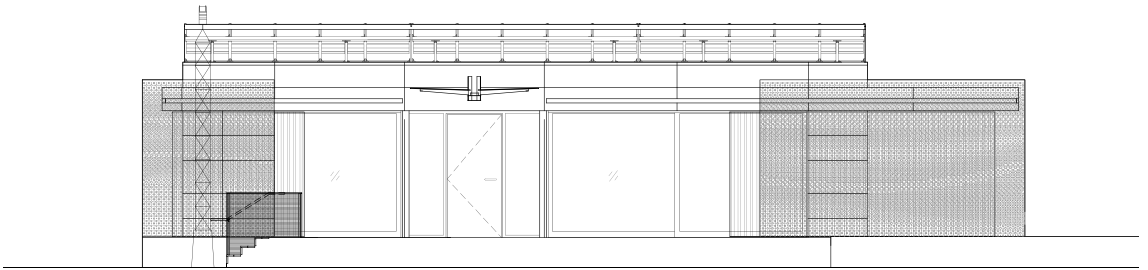

North site elevation

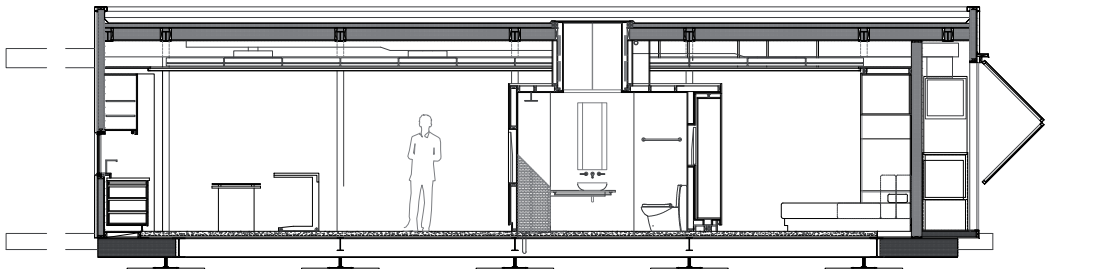

Longitudinal section-north

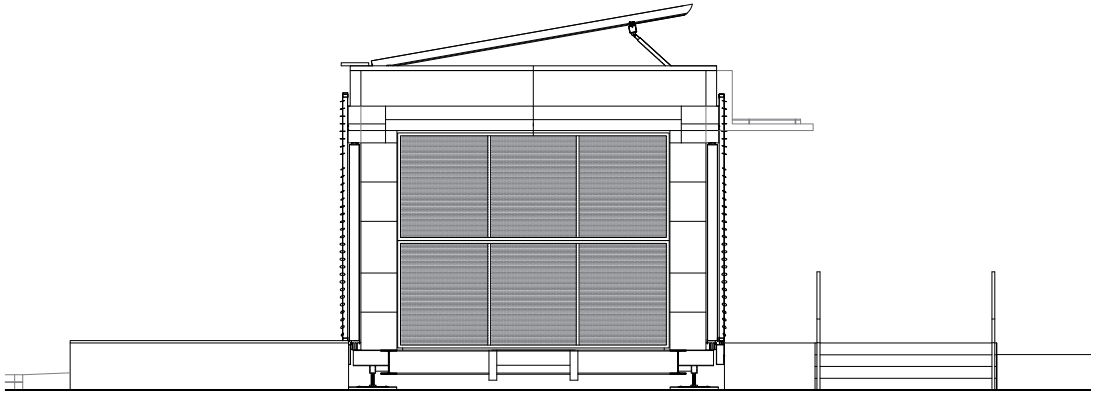

East site elevation

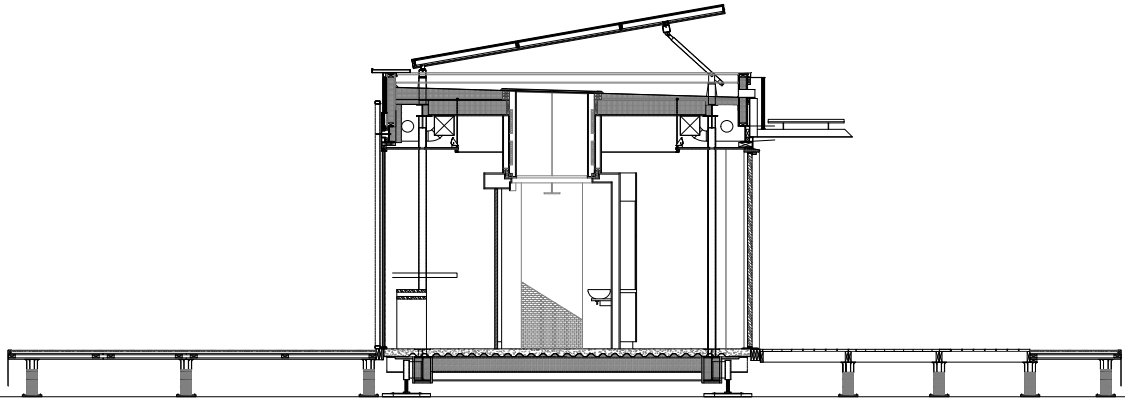

Section bathroom

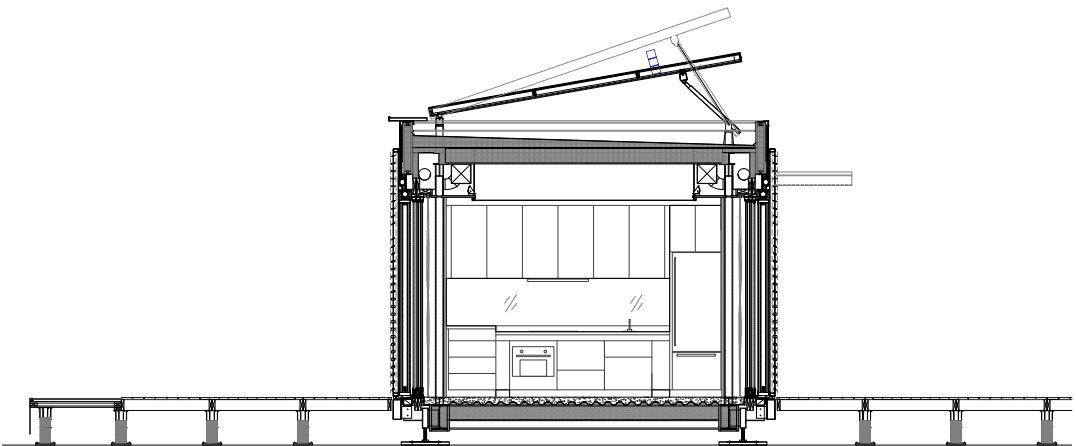

Section dining

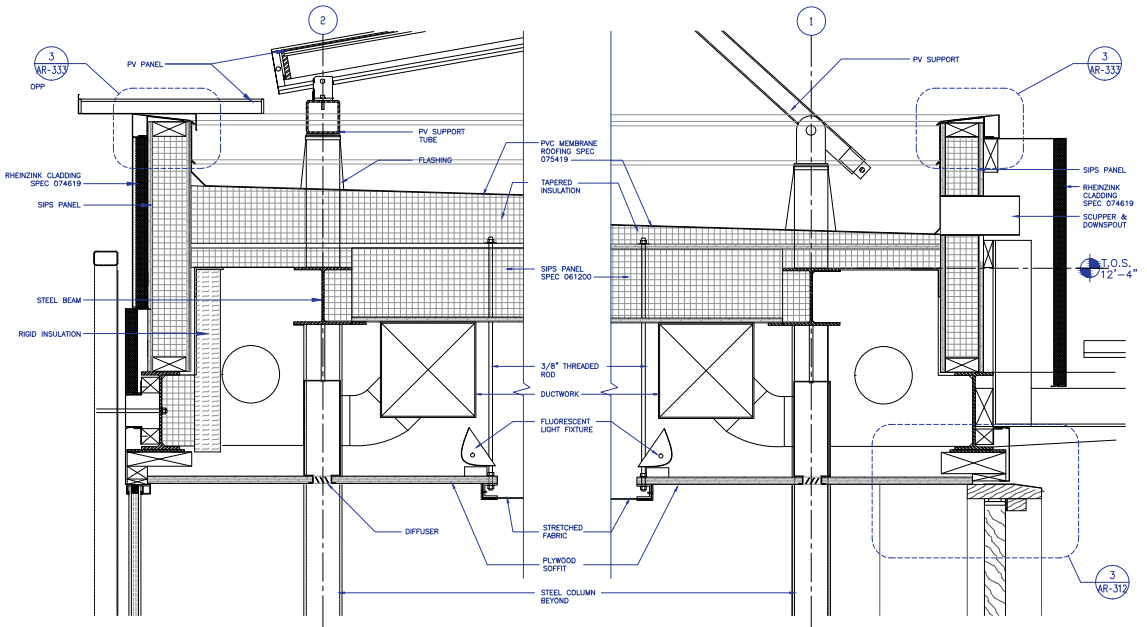

Roof detail 1

Roof detail 2

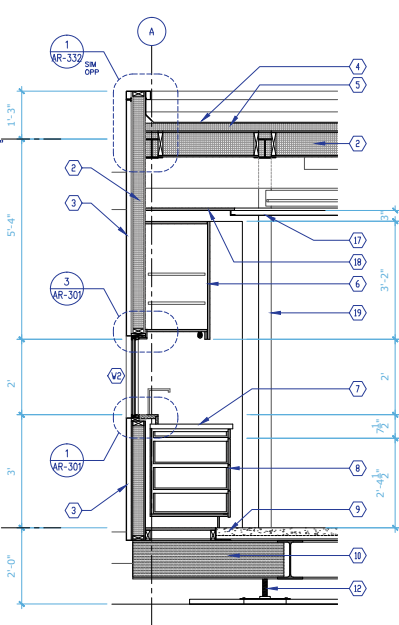
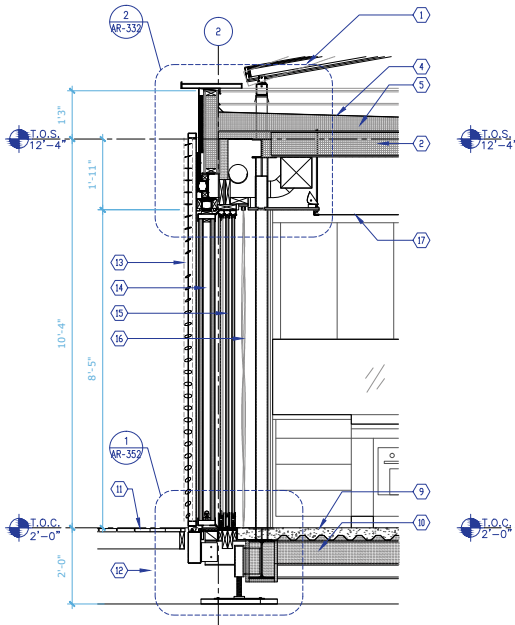

1. PHOTOVOLTAIC ARRAY
2. SIPS WALL PANEL
3. ZINC CLADDING SPEC 074619
4. PVC MEMBRANE ROOFING SPEC 075419
5. TAPERED INSULATION ON SIPS ROOF PANEL
6. MAPLE VENEERED WOOD CABINERY—PUREBOND BY COLUMBIA FOREST SPEC 064113
7. GRANITE COUNTERTOP
8. MAPLE VENEERED BASE CABINERY SPEC 064113
9. CONCRETE FLOOR ON STEEL DECK (SEE SPECIFICATIONS 030000 FOR CONCRETE SPECS)
10. SPRAY FOAM INSULATION SPEC 072119
11. IPE WOOD DECKING SPEC 061533
12. FOUNDATION SUPPORT
13. METAL SHADING/PRIVACY SCREEN
14. INSULATION PANEL
15. SLIDING GLASS DOOR SYSTEM
16. AUTOMATED DRAPERY SYSTEM
17. STRETCHED FABRIC CEILING SYSTEM
18. PLYWOOD SOFFIT FRAME
19. STEEL COLUMN BEYOND

Wall section 1

Wall section 2

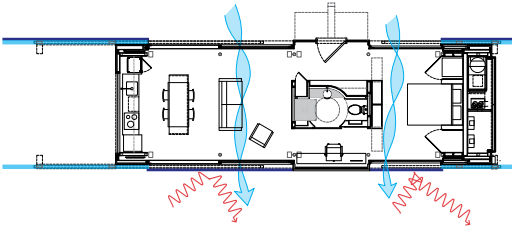

SUMMER DAY- MODERATE: All insulation panels and the northern metal screens are left open to allow for natural ventilation and maximum daylighting. The southern screens are closed to eliminate direct solar heat gain and still allow for cross-ventilation.

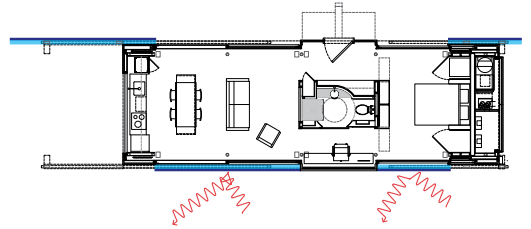

SUMMER DAY- HOT: North panels are left open to maximize natural daylight, and. Both southern panels are closed to keep out the maximum amount of solar radiation.

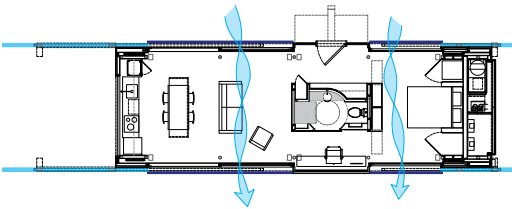

SUMMER NIGHT- MODERATE: Insulation panels remain open to allow for natural ventilation and metal screens are closed for security.

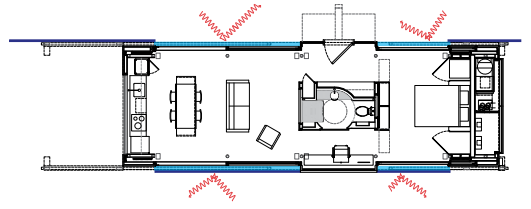

SUMMER NIGHT- HOT: Insulation panels are closed on both sides to allow the air conditioning system to work at maximum efficiency. Metal screens remain in previous positions to preserve energy by not moving.

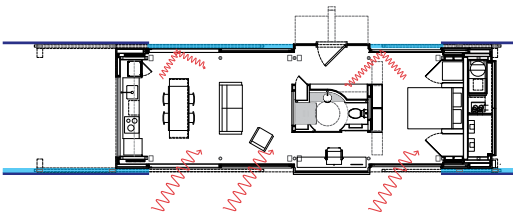

WINTER DAY: Insulation panels are closed on the north side to add insulation and southern glass is left exposed to allow for passive solar heat gain into the thermal mass of the dark-linted concrete floor. All shade screens are left open to maximize natural daylighting.

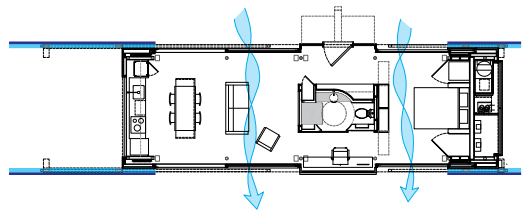

SPRING DAY: All panels are left open to maximize living space, light, and natural ventilation.

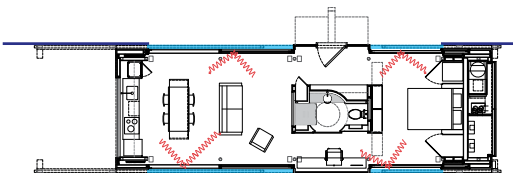

WINTER NIGHT: Insulation panels are closed to fully insulate the house, trapping the heat now being released from the concrete floor. Shade panels are left open to conserve energy by preventing the use of the electricity needed to close them.

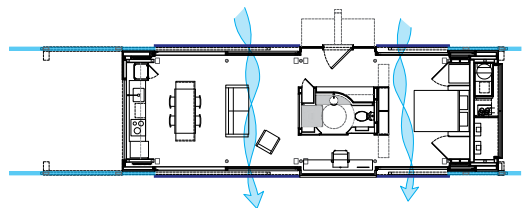

SPRING NIGHT: Insulation panels remain open to allow for natural ventilation and metal screens are closed for security.

TECHNICAL DATA OF THE HOUSE

Project name:
lumenHAUS™

Construction area:
74 m²

Conditioned area:
52,8m²

Conditioned Volume:
136,6 m³

ENERGY BALANCE

Estimated energy balance:
2.12 (ratio of energy produced/energy consumed)\Omega
+9.418,2 kWh/a (energy surplus)

Carbon Emissions Factor:
950 kgCO₂/kWh

Estimated energy production:
17.813,2 kWh/a

Photovoltaic system:
Installed PV power (kW):
10,3 kW
Types of PV Modules:
Sanyo HITT Double 190w Bifacial
(8.775 kW + bifacial contribution)
Suniva Artisun Series 3bus
Custom array size (1,4 kw)

ENERGY CONSUMPTION

Estimated energy consumption:
8.395 kWh/a (maximum 23.0 kWh/day)

Estimated energy consumption per m²:
159 kWh/m²a

Characterization of energy use:
For a one-week study in October: Appliances 20%,
Lighting 12,5%, HVAC* 67,5%.

***note: In warmer months, passive strategies will be**
utilized more to reduce the need of active cooling.

CONSTRUCTION ENVELOPE

Insulation types (type and thickness):
1,5" polycarbonate panels filled with Nanogel (Cabot
Chemical's trade name for aerogel).

Constructive Systems thermal transmittance:

	U-value (Btu/hr-sq ft °F)	R-value	U-value (W/ m ² K)
North Wall	0.037	26.7	0.210
South Wall	0.037	26.7	0.210
East Wall w/ insu	0.037	26.7	0.210
West Wall w/ insul	0.037	26.7	0.210
Roof	0.026	38.5	0.148
Floor	0.039	25.4	0.221
East glass	0.182	5.5	1.033
West glass	0.182	5.5	1.033

SPECIAL AND INNOVATIVE SYSTEMS

passive heating: thermal mass through concrete floor
passive cooling: cross ventilation through sliding
panels and Eclipsis© system
radiant heated floor
grey-water purification & rainwater harvesting system,
constructed wetlands, and hydroponic planting
schemes

COSTS

Construction Cost:
300.000 €

Industrialized Estimate Cost:
233.000 €

Team IKAROS Bavaria

Hochschule Rosenheim University of Applied Sciences, Germany

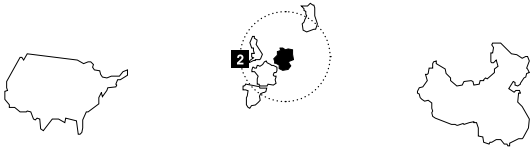

Nº.2 / 810,96 points

Contest 1: Architecture: 96,00 points.
Contest 2: Engineering and Construction: 64,00 points.
Contest 3: Solar Systems and Hot Water: 67,00 points.
Contest 4: Electrical Energy Balance: 119,90 points.
Contest 5: Comfort Conditions: 105,30 points.
Contest 6: Appliances and Functioning: 118,16 points.
Contest 7: Communication and Social Awareness: 40,00 points.
Contest 8: Industrialization and Market Viability: 62,00 points.
Contest 9: Innovation: 42,60 points.
Contest 10: Sustainability: 95,00 points.
Bonus Points and Penalties: 1,00 points.

Introduction and Main Objectives of the Project

The house designed by the Team IKAROS Bavaria combines modern design, ecologically sustainable standards and energy efficiency, thus creating a living environment which does not only correspond to the resident's needs, but also expresses a new sustainable lifestyle.

A building design was first chosen out of a competition within our university. In cooperation with students from different faculties, we came up with a well thought architectural concept which highly innovative and future-oriented character is truly impressive.

The basic idea was to create "a flexible form of living" based on modular structural elements. The interior can be used in different ways, thanks to the use of slidable furniture. This way, both great design flexibility and high efficiency are achieved.

The eye-catcher of the Team Bavaria house resides in the zig-zag facade developed, designed and built by the students of the University of Rosenheim, which gives a distinctive character to the building.

Architectural Design

We opted for the geometric form of the cube, to achieve a good proportion between the volume and the envelope of the house. This way, we minimized the loss of energy through the building shell. The cube also enhances the expressive structure of the facade.

For the colors, we chose white and light green. White represents pureness and has a great luminous power. Green stands for freshness, ecology (having a green lifestyle) and shows the connection between the residents of the house and their natural environment. We intentionally picked cold nuances for both these colors, so to create a contrast with the warm tone of the oak parquet. Wooden flooring is a naturally grown material which gives our house a native, warm character.

Exterior design. The main idea behind the design of the facade was to create a sun blind that can modify the appearance of the house throughout the day and over the course of the year, following changes in sunlight at different hours and seasons. In order to achieve this, we placed a structure with punched openings on the forehead of the glass facades, which zigzag design and sun-blinds create a very attractive and interesting play of light on the inside floor, and gives the house an interesting external structure.

On the north façade, a glass terrace allows using the exterior area in different ways. During the winter, the glass folding walls are closed inside as well as outside, and the exterior area can be used as a winter garden. During the summer, the outer and inner glass walls can be opened, creating an open space; in spring or fall, the interior folding walls are opened, while the exterior ones are closed, extending the interior living space.

Interior design. The envelope of the building functions as a natural shell that protects the core. It encloses the four modules which form the building. The first module

accommodates the function of sleeping and working. The second one corresponds to the hall area, which enlarges the space. The third one corresponds to the cooking and dining area (including the bathroom); the last module is the living area. Based on this modular construction, different floor plan settings can be created. The two external modules (east and west) are where the entrance of the roof and the previously mentioned north terrace are located.

According to the specifications of the competition, we minimized the footprint. In order to reach maximum living comfort (even though working with a limited surface), we used a flexible and functional furniture system. Different uses of the space, required at different moments of the day or night, are accommodated on the same surface. Generally, the living space is designed to be open.

Each one of the four modules offers its own possibilities of use, or a specific piece of furniture. On the whole, a homogenous, plain design brings coherence to the space.

Construction and Materials

We used wood, metal and plastic. 64% of the construction consists of wood or wooden composites. The use of metals is mostly indispensable for timber construction. Thus, our construction entails different types of steel connections (stainless steel, galvanized steel and aluminum). We used plastic mainly for sound insulation and for electrical installations. We also used it for sealing, together with silicate materials.

For insulation, we followed the following logic. For a five cm thick insulation layer, vacuum insulation achieves a heat transfer coefficient comparable to a 40 cm wood fiber insulation. Considering the restrictions of the competition in terms of built square meters, we chose vacuum insulation.

The slidable wall represents a true innovation in the field of interior fittings. Here, strongly individualized, special constructive solutions are required. For example, the

entire construction and the guiding mechanisms of the acrylic glass sliding doors (PMMA) are reinforced through a double rack substructure. The doors should overhang freely from the slidable wall: they are only fixed to the guiding rails (no overhanging) at the rear part of the door leaf.

Modularity. Our prototype is a wooden frame construction designed for two people. An innovative bend-proof wooden corner joint, combined with a wooden ribbed slab, results in a slim, stable and space-saving construction. We added vacuum insulation panels (VIP) to the wall and roof structures. The glass facade is mounted directly on the support structure of the building by using a facade carrier profile. The external jag-shaped sun protection is movable and is located below the floor level.

The modules are interconnected through metal connection systems by Knapp. They are screwed onto the sides of the main frame and can be connected to each other by inserting them from above. This way, elements shaping the entire building are held together by a simple plug-in system. Following this principle, we avoid bolted connections or nailed joints, and the modules are therefore easy to assemble on-site.

Interior Comfort, HVAC and House Systems

Windows connect the interior of the building to its environment. We wanted the residents to be able to experience this contact at any time.

A glass terrace is located in the northwest of the building. If desired, it can be opened completely, creating a smooth transition between outdoor and indoor. The terrace is delimited by a threshold-free folding system (1). On the outer side, the glazing of the system consists of a two-pane-insulating glass, and on the inner side, of a three-pane-insulating glass. All the fixed glass elements are executed with a three-pane insulating glazing, which constitutes a part of the building's thermal envelope. Access to the terrace is also facilitated by the folding/sliding system (2). The bathroom receives daylight through a ceiling-high fixed glazing window element (4). The glazing is meant to provide a high degree of visual

protection, while being highly translucent. In the south of the building, a large glass facade (3, 5, 7) offers an open view on the environment.

Our light design for the room wanted to reach an ideal exploitation of daylight. The different areas of use are arranged according to the natural path of the sun during the day. At daytime, direct sun in the living and cooking area can be optimally adjusted as desired, thanks to individually adjustable sun protections. A sufficient amount of daylight reaches the room, while the input of solar heat radiation is regulated.

For artificial lighting, we above all wanted to create a comfortable ambience while using energy-efficient technology. Such criteria could be met with the support of the Nimbus Group.

An installation wall, which looks like an ordinary kitchen rear panel, contains home automation, electrical systems and water installations. A double floor was installed all through the building, so the installations which are placed below remain easily accessible.

Cooling and heating are performed by a water / water heat pump. In summer, required cooling is provided by a buffer storage (Pcold) with a volume of 2000 l. The waste heat generated is used for drinking water heating and is collected in a buffer storage (P heat) with a volume of 300 l. In winter, the 2000 l buffer is used to store the heat energy generated, while the 300 l buffer is used for re-cooling the heat pump system. The cooling and heating energy is distributed by a cooling and heating ceiling equipped with phase change materials (PCM), which help buffer eventual temperature peaks.

A rain water cistern serves as a cold storage. The heat absorbed into the building cooling circulation (primary circulation) is transferred via a heat exchanger to the secondary circulation, where the heat is stored in the cistern. To provide re-cooling, the water in the cistern is pumped onto the roof of the building overnight. It is distributed over the surface of the roof. As it drains, it is cooled down (in the ideal case to slightly below dew point temperature) through heat emission via

convection, evaporation and radiation exchange with the atmosphere. The cooled water is fed back into the cistern via the gutter and a filter. The primary circulation is a close system, while the cistern with secondary circulation and re-cooling circulation (roof circulation) is an open system.

To comply with comfort criteria such as humidity and CO2 concentration, a controlled living space ventilation is necessary. In order to do so, we used a central device by the Zehnder Company. The device works as follows. Air from the outside is directly sucked in and cleaned through a rough material and fine filter, and pre-heated in winter. The air is heated up to approximately 4–6 °C, so that an antifreeze effect is ensured: eventual icing of the appliances is therefore prevented. Next, the outside air is led via the fan to the cross-flow/counter-flow heat exchanger, where it is heated (or cooled down in the summer) through the exhaust air.

Solar System

The roof, 70 m², has 40 photovoltaic modules. According to the first simulations we conducted - based on the information provided by the manufacturer -, from March to October, an output of more than 1000 kWh per month can be reached. We chose 96 monocrystalline cells modules by the SunPower Company.

The photovoltaic system of the house is on a 15 cm high substructure. Individual elements are mounted on the substructure following an angle of 3° from the roof cladding. Despite being nearly horizontal, the inclination is sufficient for rainwater to be drained, while presenting advantages for radiation cooling.



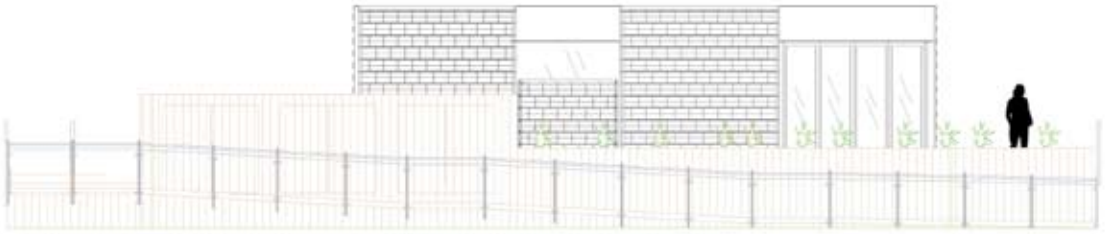

North site elevation



Floor plan

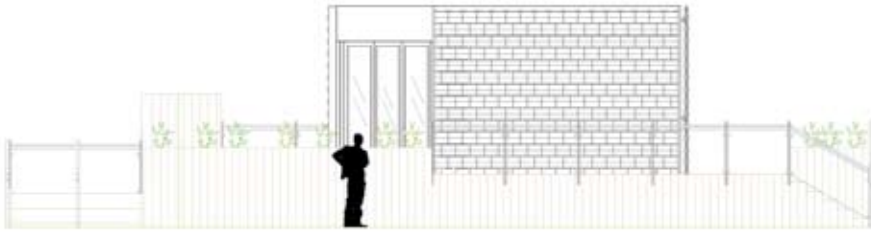

West site elevation

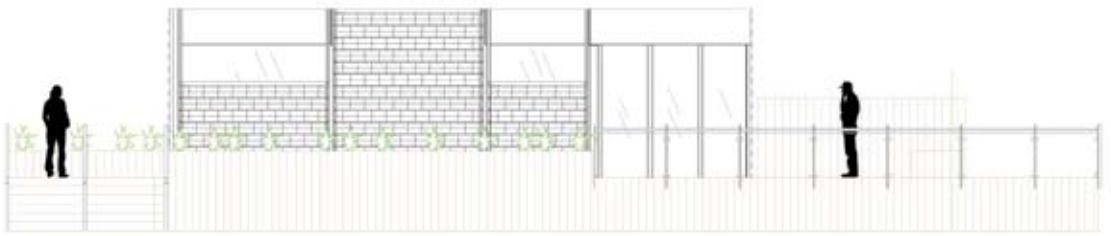

South site elevation



Longitudinal section

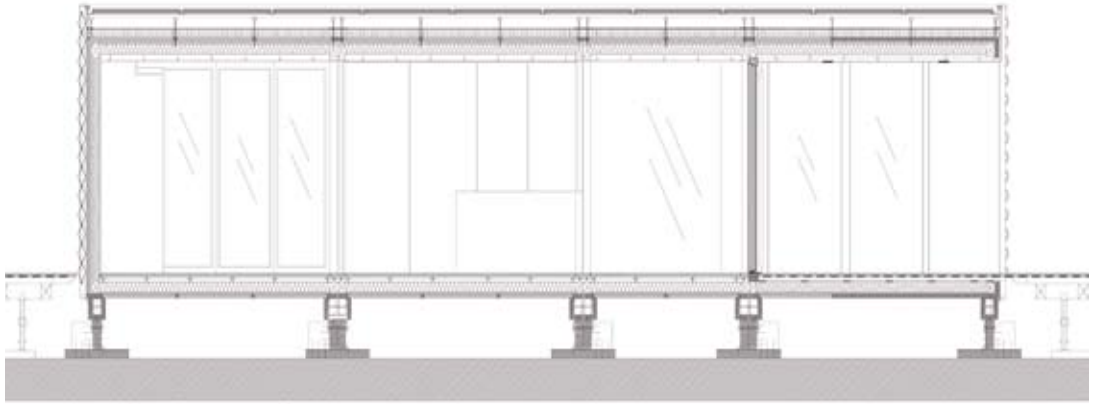

Longitudinal section

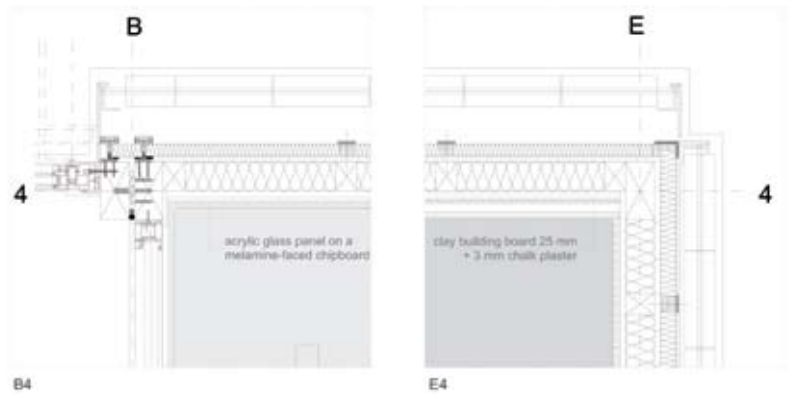

Details: wall - floor

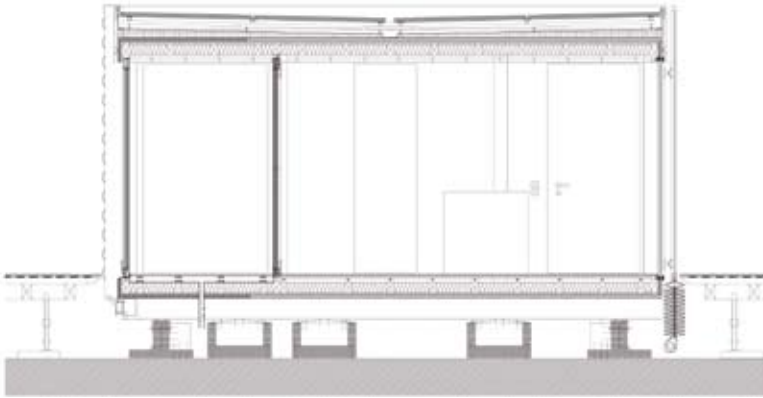

Transversal section

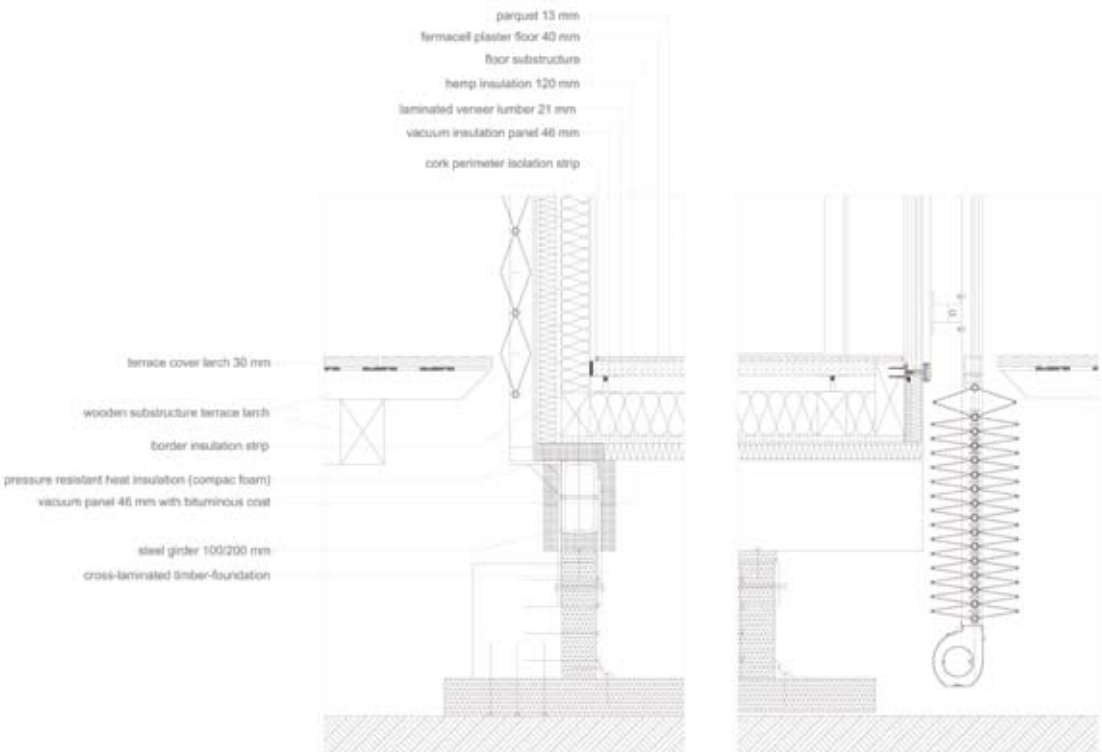

Details: floor. Inside sections

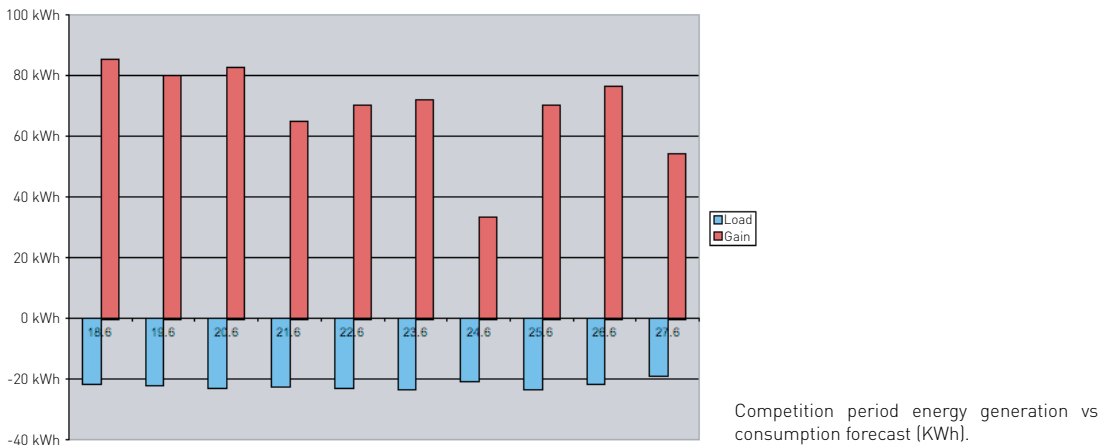
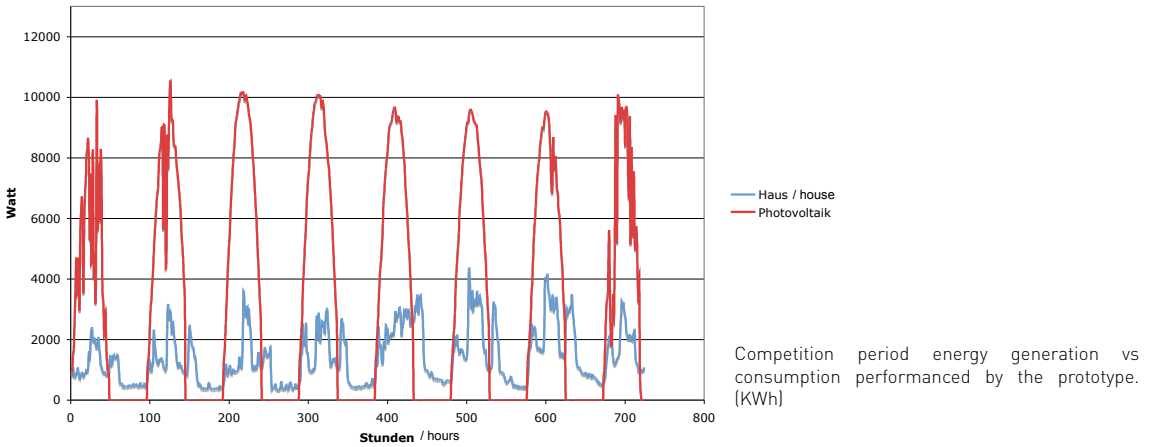
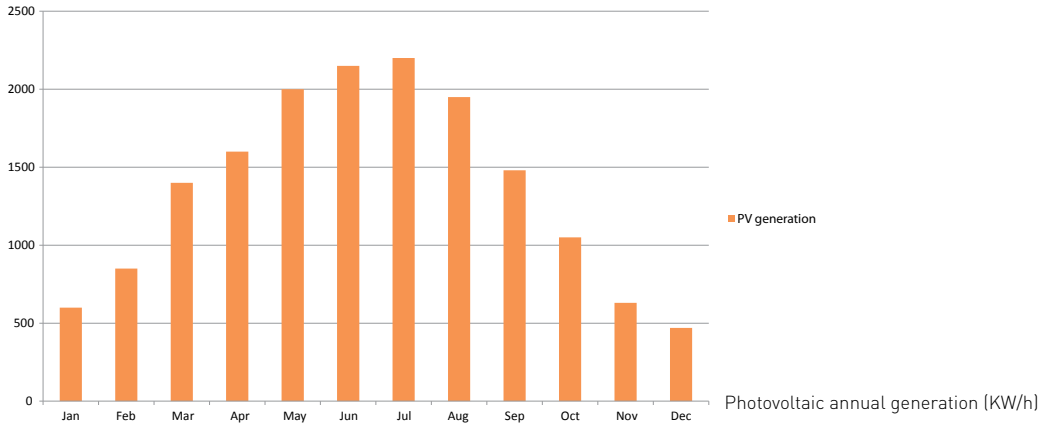

TECHNICAL DATA OF THE HOUSE

Project name:
IKAROS Bavaria

Construction area:
73,20 m²

Conditioned area:
55,00 m²

Conditioned Volume:
230,55 m³

ENERGY BALANCE

Estimated energy balance:
+11.772 kWh/a

CO₂ Emissions:
2.536 kgCO₂/a

Estimated energy production Madrid:
16.000 kWh/a

Photovoltaic system:
Total installed PV power:
12.6 kWp

Types of PV Modules:
Roof: 40 PV Monocrystalyn Modules Sun Power WTH 315
Inverter Sunny Boy SMA 3300

ENERGY CONSUMPTION

Estimated energy consumption Madrid:
4.228 kWh/a

Estimated electrical consumption Madrid:
76,87 kWh/m²a

Characterization of energy use:
Appliances 3.120 kWh/a
Heating 96 kWh/a
Cooling 352 kWh/a
Domotics 480 kWh/a
Air Handling Unit 180 kWh/a

CONSTRUCTION ENVELOPE

Insulation types (type and thickness):

Type	Gypsum	Mineral wool	Leimplatt	VIP
Width [mm]	12,2	100	20	50
Thermal Resistivity (m ² K/W)	0,0488	2,85714	0,15385	6,25

Constructive Systems thermal transmittance:

Opaque wall 0,098 W/m²K

Glazing 0,56 W/m²K

Floor 0,095 W/m²K

Roof 0,098 W/m²K

COSTS

Construction Cost:
626.712 €

Industrialized Estimate Cost:
220.500 €

home+

Hochschule für Technik Stuttgart, Germany

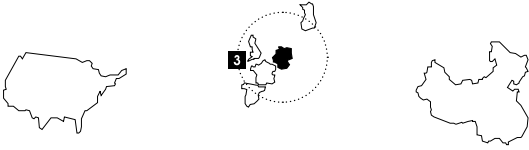

Nº.3 / 807,49 points

Contest 1: Architecture: 84,00 points.
Contest 2: Engineering and Construction: 72,00 points.
Contest 3: Solar Systems and Hot Water: 74,00 points.
Contest 4: Electrical Energy Balance: 114,55 points.
Contest 5: Comfort Conditions: 88,53 points.
Contest 6: Appliances and Functioning: 116,31 points.
Contest 7: Communication and Social Awareness: 40,00 points.
Contest 8: Industrialization and Market Viability: 51,30 points.
Contest 9: Innovation: 51,80 points.
Contest 10: Sustainability: 110,00 points.
Bonus Points and Penalties: 5,00 points.

Introduction and Main Objectives of the Project

The Solar Decathlon Europe is an international competition open to universities from all over the world. The objective is to design and build a self-sufficient home, grid-connected, using solar energy as the only energy source and equipped with technologies maximizing energy efficiency - at the highest architectural design level. It is a great chance for students and schools of architecture to gain experience, to exchange ideas and to promote the concerns of energy-efficient and sustainable building.

In October 2008, our interdisciplinary team of architects, interior designers, structural engineers and building physicists at the Hochschule für Technik Stuttgart (HFT) accepted the challenge, and worked together on the design of the building. The basic idea of our design 'home+' was to use traditional means of dealing with the climate in hot and arid zones and to combine them with new technologies. Thermal mass, sun shading and evaporative cooling will help to achieve a comfortable indoor climate with passive means. The key element of our passive cooling concept is a new building component that we call "energy tower", which is also an important feature of the interior design. In addition, night cooling via sky radiation and evaporation is used to discharge phase change material (PCM) material embedded in the house's ceilings. Active cooling is supplied by a compact reversible heat pump with a capacity of 2.4 kW powered by photovoltaics.

The competition took place in June 2010 in Madrid.

Our project, home+, finally ranked 3rd, only 4.5 (out of a possibility of 1000) points behind the winner. However, it received the first award under both the rubric "engineering and construction" and "innovations"; we won the second place for "Solar Systems" and "Appliances and Functioning", and finally the third prize in "Sustainability".

Architectural Design

The design is based on architectural and energetic considerations. The starting point is a compact and highly insulated volume with a small surface to volume ratio. The volume is segmented into four modules, which are positioned with interspaces between them.

These gaps are used for lighting, ventilation, pre-heating in the winter and passive cooling in the summer. One of these gaps is higher than the others, containing the "energy tower". Based on traditional principles of climate control, the energy tower is a key element for the energy concept as well as for the outer appearance of the building and the interior space. The modules and the gaps are bound together by the building envelope, which is covered in large areas with photovoltaic elements.

Zoning. The interior shows a clear zoning and a reduces the use materials to few, selected ones: white vertical surfaces, natural oak for most horizontal surfaces including the floor, green felt for the module niches and the cushions of the seats. The key structure is emphasized by light grey lines: visible primary timber structure and wooden window frames.

In the north-south direction, the terrace, the living area and the dining area are marked by the gaps, yet they also can be used as one big space. This revealed useful, as for example, the two times we invited our neighbors of the solar village over for dinner. A more private working and sleeping area is separated by the volume of the energy tower. In the east-west direction, each area is accompanied by a serving zone (kitchen, entrance and facilities, bath).

Modularity. The modular design of the building does not only facilitate the transport and the assembly in Madrid, but also allows thinking about a modular building system meeting different requirements. By using the same basic modules, we can create living and working space for singles, couples, families or apartment-sharing communities in detached and semi-detached, as well as in multi-family houses.

Interior comfort, HVAC and House Systems

The basic idea of our design is to use traditional means of dealing with the climate in hot and arid zones and to combine them with new technologies. Thermal mass, sun shading and evaporative cooling will help to achieve a comfortable indoor climate with passive means. The key element of our passive cooling concept is a new building component that we call "energy tower", which is also an important feature of the interior design. In addition, night cooling via sky radiation and evaporation is used to discharge phase change material (PCM). Active cooling is supplied by a reversible heat pump powered by photovoltaics. Since the competition occurred in June in a Southern Europe country, the most challenging part was to satisfy the comfort level in cooling mode

Low energy night cooling systems. The energy tower supplies passively part of the ventilation and the cooling needs, through evaporative cooling when the ambient conditions are not extreme (not too hot, not too humid). Free cooling operates in moderate climate conditions and/or at night by letting the air flow through the openings in the gaps.

During the day, the PCM ceiling uses the latent heat

of the PCM to store the heat and to maintain the room temperature around the melting temperature (21-23°C). During the night, the PCM ceiling is actively regenerated using cold water from the night radiative cooling system on the roof (PVT-collectors). The cold water is stored in a cold storage and used during the day to activate the radiant floor. This was achieved with an innovative storage management combining a storage tank (water) with PCM integrated in the building construction (ceilings). During the winter, a 1200 liters water tank is used to store the heat from solar collectors in order to increase the water-water reversible heat pump efficiency. In summer, during the day, part of the cooling loads is taken passively by the PCM and the store is used as a heat sink by the heat pump in chiller mode. During the night, a radiative cooling system using hybrid photovoltaic-thermal (PVT) collectors discharge the PCM and rejects the heat of the store to the ambient. Simulations show that around 30% of the cooling loads are covered by the PCM, another 15 % are supplied in free cooling mode (when the water from the store is directly used to cool the building) with very low energy input. Additionally, the heat pump is operated very efficiently in both heating and cooling mode (seasonal performance factors of 4.3 and 4.2 respectively). The electricity consumption for the HVAC systems is therefore reduced to a minimum and the electricity balance of the house is largely positive (surplus of 7500 kWh/year) for the climate of Madrid. Measurement data during the competition confirmed the previously simulated results.

The conventional ventilation system (active) is equipped with a heat recovery system between the return air and the supply air for winter and summer. Additionally, an indirect evaporative cooling device enhances the cooling capacity through ventilation in summer.

Back-up cooling system. When the passive or the low energy cooling systems do not cover the demand, the reversible heat pump removes heat from the radiant activated floor to cool down the house. The choice of an electrical solution for the back-up is due mainly to the lack of thermally driven chillers in the range of small power and the lack of space available for the equipments (solar collectors, heat rejection devices, etc.). Therefore,

the facades and the roof are covered with PV modules in order to provide the electricity needs of the house and inject the rest into the grid. A classic solar thermal system provides domestic hot water for the building.

System integration. All the HVAC components of the house have been integrated into a complex hydraulic system. The so-called "heat sink tank" (HST) is an essential part of this installation, since it is involved in all energy exchanges for both heating and cooling. In the case of cold winter sunny days, the vacuum tube collectors (VTC) deliver heat to the solar tank; the PVT collectors feed the heat sink tank in order to enhance the efficiency of the heat pump that supplies heat into the building via the activated floor. When only low irradiance is available, the VTC can supply solar heat into the HST in order to avoid freezing.

In summer, the HST is used during the day to store the heat rejected by the heat pump in chiller mode. When the temperature in the HST is below 19°C, the free-cooling mode can be operated. The PCM ceiling takes passively part of the cooling loads during the day. During the first part of the night, the PVT collectors regenerate the PCM ceiling by radiative cooling; afterwards they can reject the heat stored in the HST.

Control strategy. We favored passive technologies and gave priority to technologies that require low parasitical energy:

Priority	Subsystems
1	PCM ceiling
2	Energy tower (if possible)
3	Free cooling
4	Night cooling / activated floor
5	Indirect evaporative cooling
6	Reversible heat pump

Thermal Comfort. Thermal mass (PCM), sun shading devices and evaporative cooling help to achieve a comfortable indoor climate with passive means. The "ventilation tower" supplies passively part of the ventilation and cooling needs by evaporative cooling using the wind as driving force. Mechanical ventilation

with heat recovery and indirect evaporative cooling systems is used to reduce heat losses in winter and provide additional cooling in summer. Active cooling and heating is supplied through a radiant floor (30 m²) by a reversible heat pump powered by photovoltaics. At night during the summer, a radiative cooling system using newly developed hybrid PVT collectors (36 m²) regenerates the PCM ceiling (18 m²) and takes up the heat rejected from the reversible heat pump by cooling down the "heat sink tank" (HST).

If possible, a free cooling mode is run by pumping the cold water directly from the heat sink tank to the radiant floor. Dehumidification of the supply air can be done with the reversible heat pump through a fan coil by cooling the air below the dew point. Domestic hot water (DHW) needs are covered by vacuum tubes collectors (6.6 m²) which feed a 300 liter solar tank with electrical heater back-up. The thermal collectors also provide shading in the area of the glazed gaps by the geometry of the absorbers. In winter, when necessary, the solar thermal system provides heat to the heat sink tank in order to increase the heat pump efficiency.

Solar System

Innovative PV modules. With regard to a unique design, we included different facade and roof PV modules. The roof should provide a maximum of electricity output. Roof and facades are visually connected using different colors for the cells, forming a unique 'pixel design'. The colors of the cells are gold and bronze on the roof edge and the façade, while the roof is covered with monocrystalline black cells. Overall installed power is about 12.5 kWp.

The PV system consists of about 66 m² of two-color (Gold/Bronze, 13% cell eff.) polycrystalline cell modules on both east/west facades and parts of the roof, and of 33 m² of monocrystalline cells (17% cell eff.) for the PVT modules, also on the roof.

Singular Systems

System simulation results and measurements in Madrid. The house, with all the HVAC equipments

and the complete hydraulic, was simulated with TRNSYS for the climate of Madrid. A detailed model for radiative cooling with PVT collectors was developed and implemented in the simulation. We used Meteoronorm weather data for the annual simulation of Madrid city. The PV installation was simulated separately with the simulation environment INSEL.

Due to the large PV system installed, the electricity balance is highly positive (7500 kWh surplus annually for Madrid). However, the specific electricity consumption is relatively high (68 kWh/m²a). This is mainly due to the building management system (BMS) and to the house appliances (70%). Due to the efficiency of the energy concept and the chosen components, the HVAC equipments are responsible for only 25% of the total electricity consumption. The radiative cooling system with PVT collectors, in combination with the HST, work very efficiently since it covers about 45% of the cooling loads (PCM + free cooling mode). The calculated mean cooling power for the PVT is around 40 W/m² and the mean electrical COP of the system is 30.

The measurement results of Madrid also show that the radiative cooling system with PVT collectors worked very well.

As both simulated and measured results show, due to an innovative storage management combining a water storage tank and PCM integrated in the ceiling, the thermal conditions inside the prototype building home+ could be kept within comfort range at very low energy demand – even during hot periods. Our experiences confirm the results of the simulations we realized beforehand: due to an innovative storage management combining a 1.2 m³ water storage tank and PCM integrated in the ceiling, the thermal conditions inside the prototype building home+ could be kept within comfort range at very low energy demand – even during hot periods. Our concept and its relative complex hydraulic system might look disproportionate for a small residential building – this, however, is due to the specific requirements of the competition, which demanded indoor temperatures between 23°C and 25°C. Moreover, it offered the opportunity to deal with technical solutions

that show potential for further research at HFT Stuttgart. In particular, the newly developed PVT collectors proved their capability of generating cooling energy at minimal expense of electricity. Amongst others, these innovative components will therefore be the object of further examination - when home+ is going to be set up as a permanent research facility at Stuttgart.

Text by Prof. Dr. Jan Cremers and Nansi Palla, M.A.

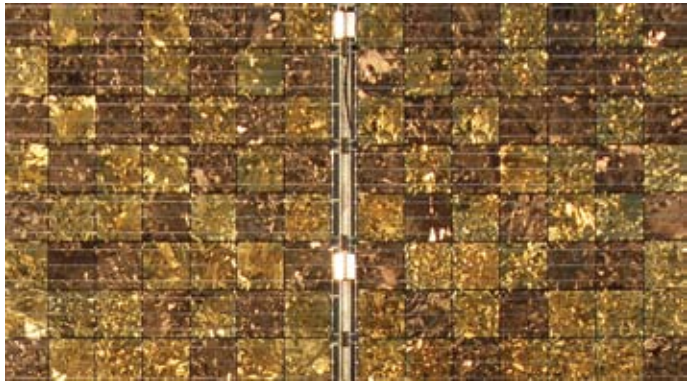

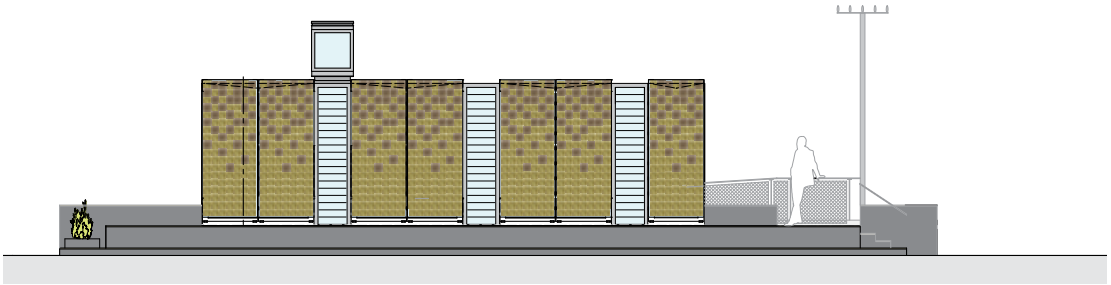

West site elevation

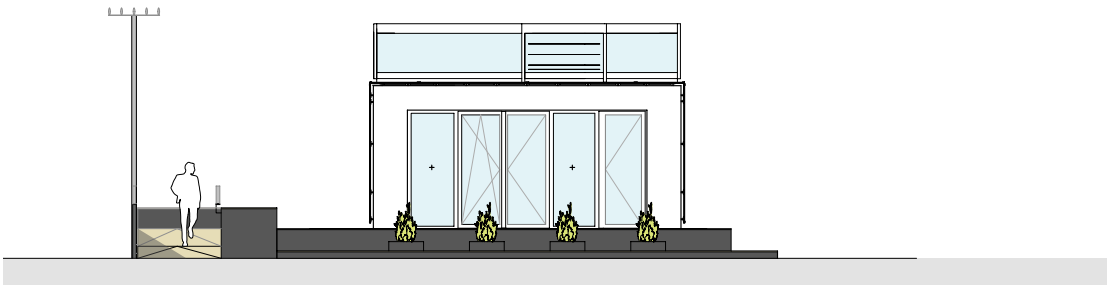

North site elevation

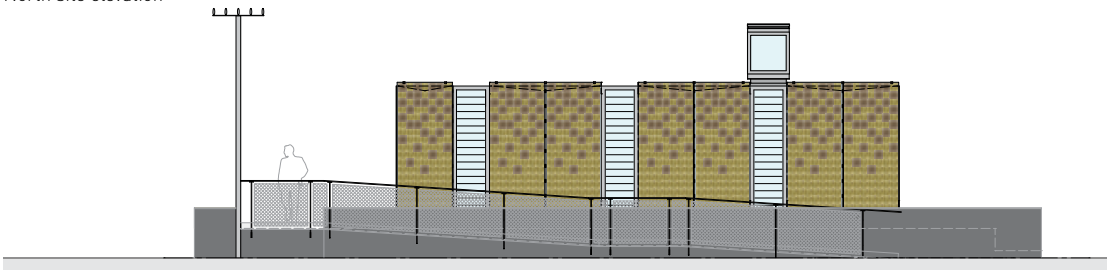

East site elevation

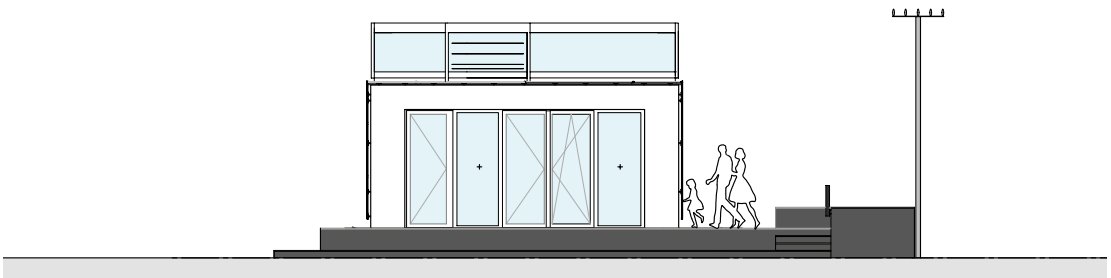

South site elevation

direct radiation
diffuse radiation

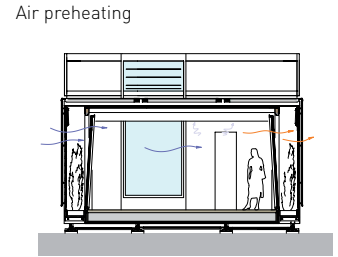
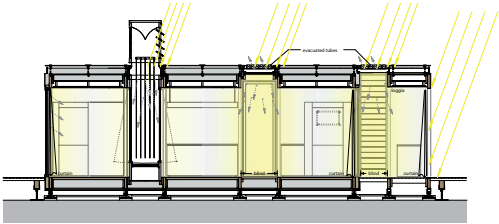
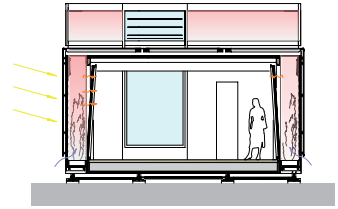
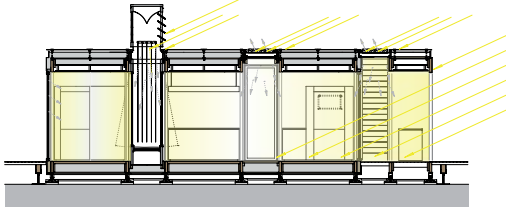

Cross ventilation

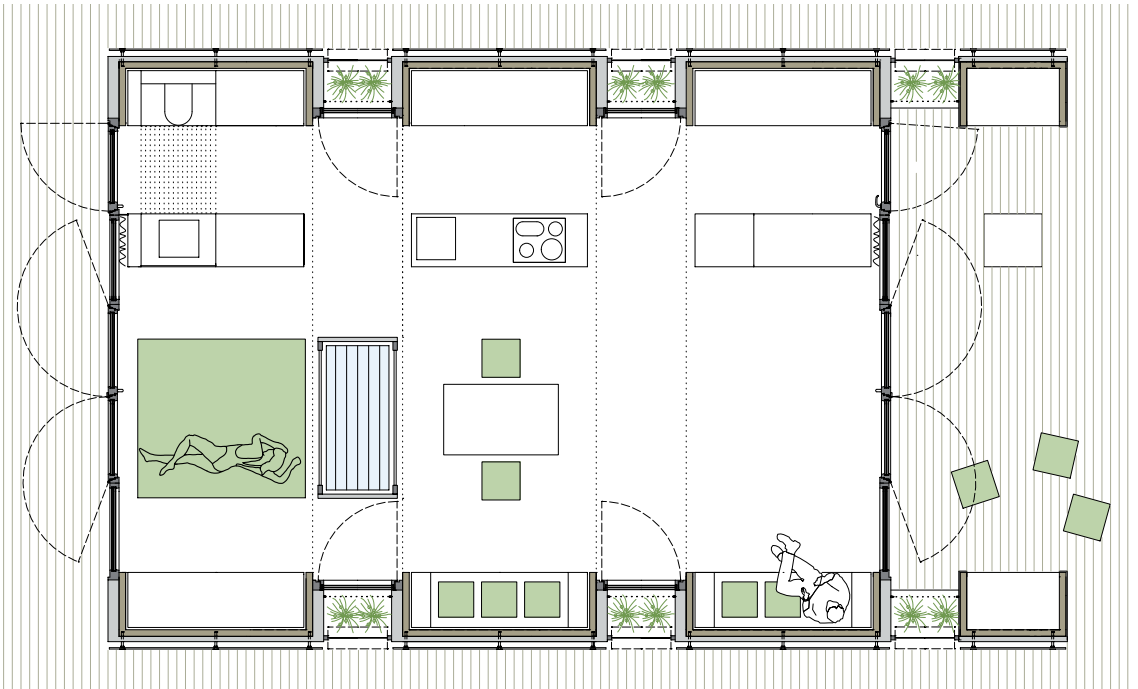

Floor plan

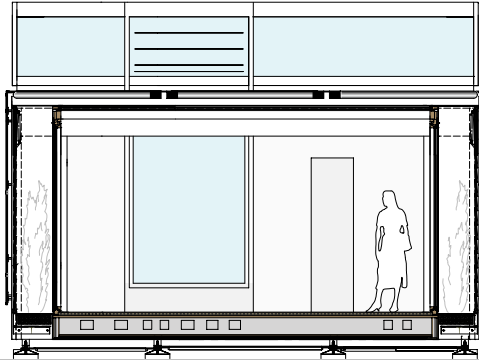

Transversal section climate gap

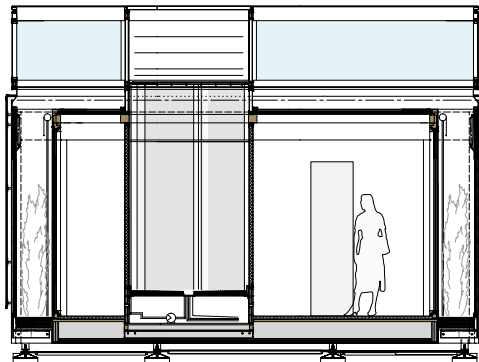

Transversal section ventilation tower

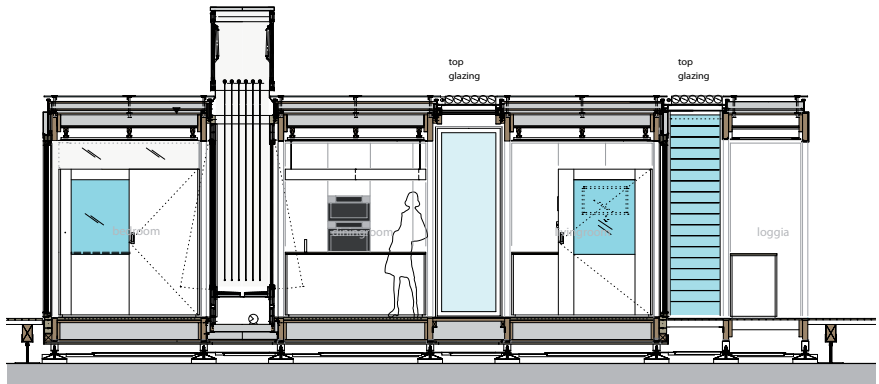

Longitudinal section

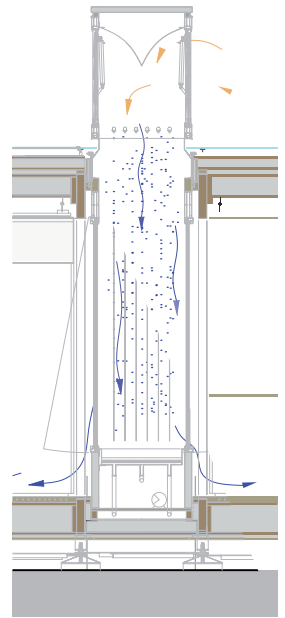
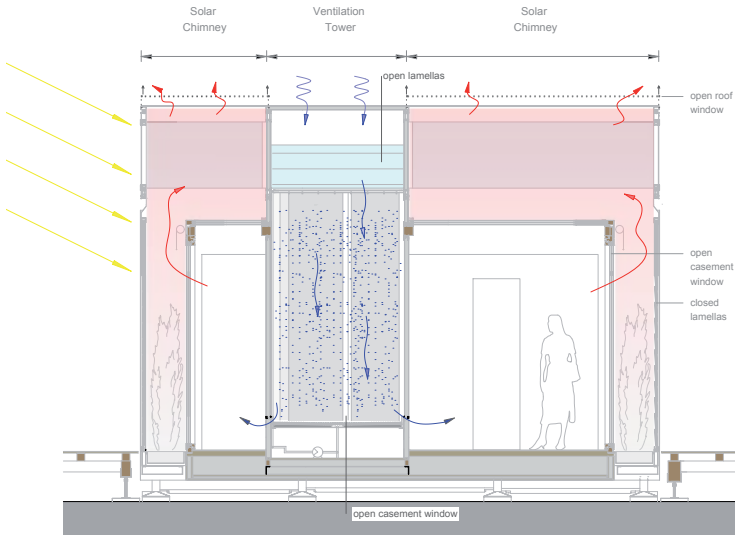

Sections: energy tower.

- 1 Roof:
 - Photovoltaic glass/glass modules with laminated PV cells
 - air layer
 - waterproofing RAL 9016
 - OSB panel, slope 3 %, 20 mm
 - insulation (sheep wool) 120 mm
 - OSB panel 20 mm
 - Vacuum-insulation-panel, two-ply 40 mm
 - OSB panel 25 mm
 - crossbeam 80/160, with insulation between crossbeams (sheep wool) 160 mm
 - OSB panel 22 mm, vapour barrier fully surfaced
 - taken down ceiling
 - cooling ceiling 54 mm, PCM boards 10 mm, gypsum plaster board 20 mm RAL 9016
- 2 Load carrying system for the photovoltaic modules, pointed fixing
- 3 evacuated tube collectors direct floor
- 4 Triple glazing U-Value 0.5 W/m²K:
 - toughened safety glass 6 + Argon 18 + toughened safety glass 4 + Argon 18 + laminated safety glass 6 mm, g-Value=48 %
- 5 Floor:
 - waterproofing
 - OSB panel 20 mm
 - Vacuum-insulation-panel 24 mm
 - OSB panel 22 mm
 - wooden beam ceiling TII 60/240 mm with insulation between crossbeams (sheep wool) 240 mm
 - OSB panel 30 mm
 - floor heating/cooling 30 mm
 - floor cover, oak white oiled 10 mm

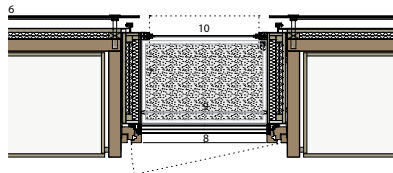

- 6 Wall:
 - Photovoltaic glass/glass modules with laminated PV cells
 - air layer
 - waterproofing RAL 9016
 - OSB panel 20 mm
 - Vacuum-insulation-panel, two-ply 40 mm
 - vapour barrier fully surfaced
 - wood construction FSH 75 mm
 - furnishing 650 mm

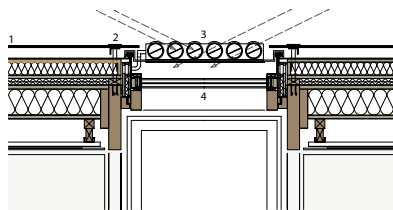

- 7 Gaps:
 - Aluminiumverkleidung beschichtet in RAL 9016 3 mm
 - OSB panel 12 mm
 - Sheep wool 40 mm
 - Vacuum-insulation-panel, two-ply 40 mm
 - OSB panel 20 mm
 - Wood construction FSH 75 mm
 - Furnishing
- 8 Triple glazing U-Value 0.5 W/m²K:
 - toughened safety glass 4 + Argon 18 + toughened safety glass 6 + Argon 18 + laminated safety glass 4 mm, g-Value = 50 %
- 9 Sun shading
- 10 Lamella glazing h = ca. 250 mm

Detail: horizontal section gap
Detail: vertical section gap

TECHNICAL DATA OF THE HOUSE

Project name:

home *

Construction area:

74,00 m²

Conditioned area:

52,11 m²

Conditioned Volume:

208,51 m³

ENERGY BALANCE

Estimated energy balance:

+7596 kWh/a

CO₂ Emissions:

2.291 kgCO₂/a

Estimated energy production Madrid:

11.415 kWh/a

Photovoltaic system:

Total installed PV power:

12,5 kWp

Types of PV Modules:

Roof: PV module ERTEX with Sunways cells.

47,50 m²

East/West: PV module ERTEX with Sunways cells.

51,40 m²

Inverters: Sunways AT2700

ENERGY CONSUMPTION

Estimated energy consumption Madrid:

3.819 kWh/a

Estimated electrical consumption Madrid:

69,31 kWh/m²a

Characterization of energy use:

Appliances 1.314 kWh/a

HVAC+DHW 768 kWh/a

MSR 1.314 kWh/a

Hp Compressor 314kWh/a

Inverters 109 kWh/a

CONSTRUCTION ENVELOPE

Insulation types (type and thickness):

Type	Sheep Wool	Vacuum Insulated Panel
Width	210-240	24-40
Thermal Conductivity	0,04	0.007

Constructive Systems thermal transmittance:

Opaque wall 0,16 W/m²K

Wall south-north 0,13 W/m²K

Glazing 0,52 W/m²K

Floor 0,10 W/m²K

Roof 0,11 W/m²K

COSTS

Construction Cost:

663.169 €

Industrialized Estimate Cost:

220.000 €

Armadillo Box

École Nationale Supérieure d'Architecture de Grenoble, France



N°.4 / 793,84 points

Contest 1: Architecture: 108,00 points.
Contest 2: Engineering and Construction: 64,00 points.
Contest 3: Solar Systems and Hot Water: 60,75 points.
Contest 4: Electrical Energy Balance: 116,55 points.
Contest 5: Comfort Conditions: 99,17 points.
Contest 6: Appliances and Functioning: 93,37 points.
Contest 7: Communication and Social Awareness: 56,00 points.
Contest 8: Industrialization and Market Viability: 53,70 points.
Contest 9: Innovation: 47,30 points.
Contest 10: Sustainability: 100,00 points.
Bonus Points and Penalties: - 5,00 points

Introduction and Main Objectives of the Project

Armadillo Box has learned from the tattoo lesson: it regulates its indoor atmosphere as well as the microcosm.
The Grenoble team.

«Armadillo» is a Spanish word that means «little one in armor». It refers to the leathery armor, i.e. the shell that covers the tattoo's head, back, paws and tail. Thanks to its slow metabolism, the armadillo produces little heat. It regulates its body heat by cooling down the blood that runs from its heart through its arteries, with fresh blood that comes up from its paws which are in contact with the ground, through a network of veins curled up around the arteries.

In order to develop the armadillo strategy, our team decided to explore the CORESKIN-SHELL concept, which allows to conceptually decompose each part of the house by giving them a series of homogeneous and non contradictory functions. The Armadillo Box has three easily identifiable parts: a core, a skin and a shell. The core is the technical node: it is produced like an industrial component, and includes the machinery and fluids. The skin is a low tech and low cost thermal envelope built on site. It covers the core and the interior spaces of the house, providing insulation and waterproofing. The use of soil as a construction material for the skin impressed the jury, who praised its aesthetics, its constructive solution, and its thermal performance. The shell is a high tech, outer envelope who enfolds the skin. It protects the house from the sun and collects solar energy. It is prefabricated according to

the specific dimensions of the house. The combination of these three elements gives the Armadillo Box an "armor" which protects it, increases its energy efficiency, and produces electrical energy.

Architectural Design

The interior of the house is organized around a technical core that is located at the heart of the interior space. The technical core is located on the north side; it comprises the technical block, the kitchen, the bathroom, the studio and the storage. The living room area is an open space which furniture can be reconfigured according to the resident's moods. Large bay windows provide openings connecting the inside and the outside, through a shaded, south oriented porch.

Construction and Materials

The Armadillo Box relies on the following architectural concept: an affordable solar house based on the "deconstruction" of the building system. In order to speed up the production, and to reduce the "assembly on site" phase, the house is designed in three independent pieces, each of which exploits a different mode of production.

The core is an industrialized component where all technical equipments are located (kitchen and bathroom appliances, Murphy's bed, HVAC system, electric panels, inverters and PV connections, etc.).

The skin is a high performance thermal envelope based

on a simple building technique using STEICO wooden l section beams and OSB sheeting with wood fiber insulation that can be locally produced (even by unskilled workers if properly trained by some specialists). From there, self construction is therefore possible. The thermal envelope also features a high performance triple glazing on large facades, which value passive solar gains and minimize heat losses.

The shell is prefabricated. It is a custom made steel structure which holds PV panels and is efficient in terms of solar protection. It is fabricated by specialized steel builders equipped with CNC tools. When thinking about costs reduction, time is the key factor. Prefabrication and industrialization reduce the time needed for the construction; it allows a better control of the quality, and induces significant decreases in the cost of labor. Self construction and local craftsmanship also make good use of local resources and contribute to local development. Overall, it also creates better conditions of financing, as well as it significantly increases the optimization of fees.

We chose wood as the main material for the Armadillo Box. We used it in several forms such as: solid wood, blades of composite wood (WEX by Piveteau), structural posts and beams (Steico), wooden fiber insulation (Pavatex) and panels OSB4 (Kronotex). We also used soil, glass, steel and technical textile. Soil was used for the exterior layer on the east and west facades, and for the radiant panel on the inside. North and south openings are made of wood frames, triple glass doors and windows (Optiwin/Glasstrosch by Joinery André). The structure of the external shell is in steel. It supports the solar modules, the facade blinds as well as the exterior textile roller blinds (Solatis/Ferrari).

Interior Comfort, HVAC and House Systems

The house is organized around a technical core that is located at the heart of a "free space". This technical core is located on the north side of the habitable space, and regroups the following equipments:

- A technical block where all the functional elements of the house are located (NILAN VP18, electric board, laundry room). These elements generate a lot of heat. For that reason, we grouped and isolated them from the rest of the house.
- A Schmidt kitchen with modern commodities (oven, refrigerator, cooking area, selective waste disposal cans, storage, etc.).
- A bathroom with shower and toilets.
- A study with storage.

The indoor space is organized around this central core. During the day, it is closed and people live in the "free space" of the house. At night, it opens up: the main living area can be divided in two areas, with the help of the bed which unfolds from the core.

If need be, two sliding walls, which are integrated into the core, allow separating the kitchen and the bathroom from the living room. On the kitchen side, this wall blocks smells and minimizes the propagation of moisture in the house, particularly during the winter. It provides the resident with choices in spatial configurations. Some people like cooking in front of everyone. Others prefer a closed kitchen for confidentiality. On the toilet side, three sliding panels allow freeing the bathroom area, doubling its size and bringing in direct light from the large northeast bay window. Wheelchair access is also guaranteed. Intimacy is regulated by a "command and control" occultation system. The house is equipped with a three in one compact HVAC unit (Nilan VP 18) which introduces a heat recovery system, and produces hot water through the heat pump. This unit uses the calories that are generated by the production of cold, and transfers it to the hot water reserve. Heating and cooling needs are partly ensured by the ventilation system, which can blow warm or cool air in the living volume. The east and west interior walls feature earth radiant panels (WEM) with an embedded hydraulic radiant pipes (16 mm) network. Combined with the air/water heat pump, it provides additional radiant cooling in summer. The thermal mass of the panel may induce a "dephasing effect" after shutting down. On the final location of the house, panels will be connected to a geothermal heat pump. We attempted to engineer the outdoor environment by an adjustable shade device and by the integration of draught evaporative cooling in porous semi defined boundary conditions.

Solar Systems

The PV modules have been installed on the exterior shell: on the roof, 42 polycrystalline panels with a peak power of 10.5 kWp; on the south face, one row of seven panels with a peak power of 1.75 kWp; on the east and west side, 24 panels on each face with a peak power of 1.8 kWp per face. All PV are divided in six solar arrays wired to three Schneider SunEzy 600E inverters. Two strategies are used to reduce overheat of the PV panels. First, they are installed 80 cm above the roof; second, we installed a fogging nozzle system (BRO) which creates an evaporative cooling effect under the panels.



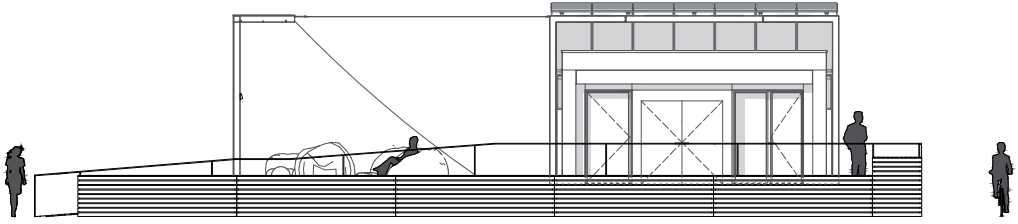

North site elevation

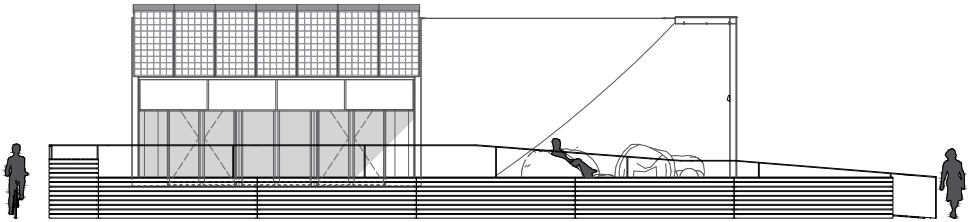

South site elevation

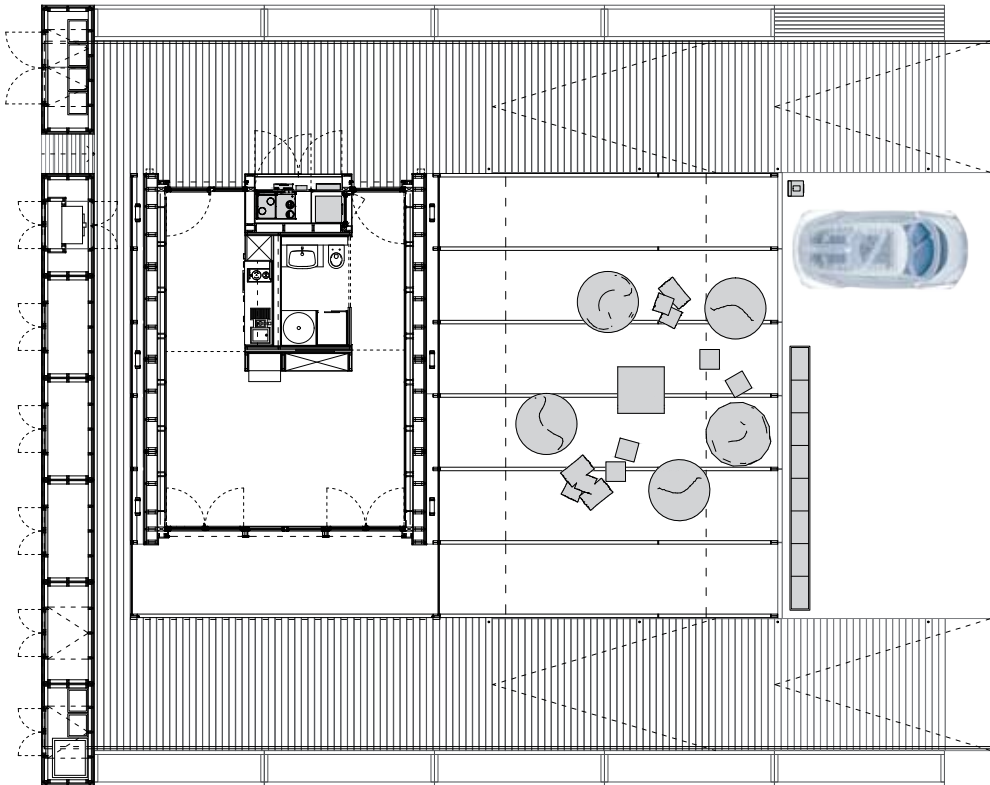

Floor site plan

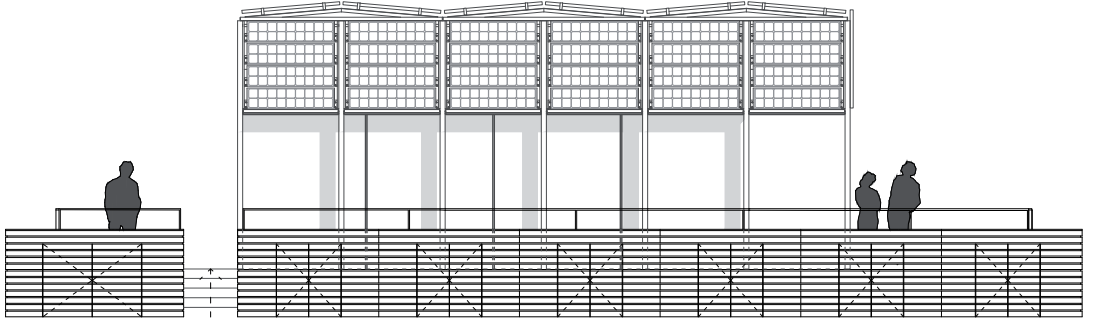

West site elevation

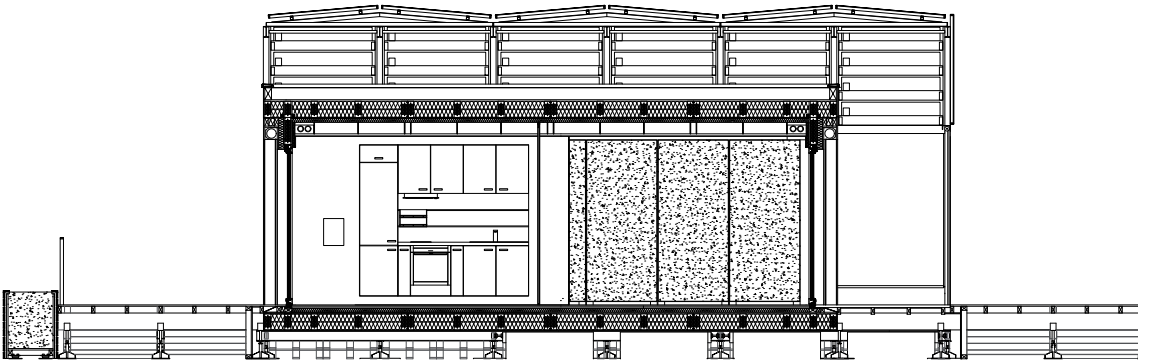

Longitudinal section

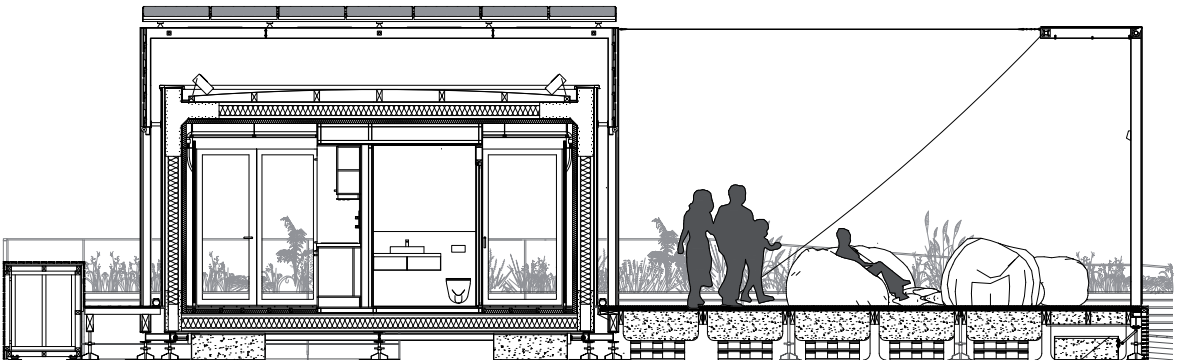

Transversal section

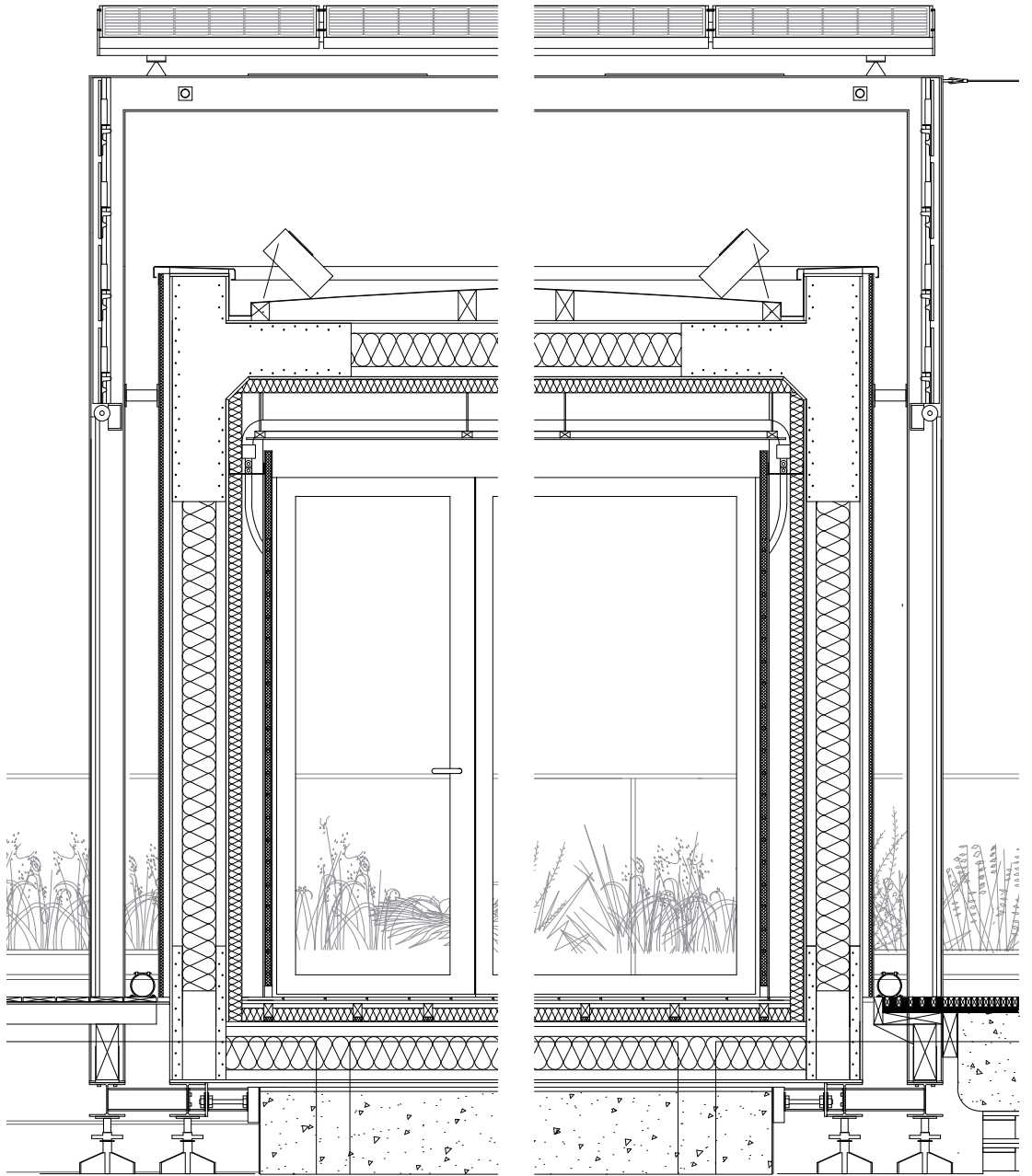

Wall details

A Winter nights, passiv energetic strategy - Longitudinal section
 BA-003 Stratégie énergétique passive nuit en hiver - coupe longitudinale



At night, blinds are rolled down in order to protect the thermal envelope from cold winds' radiative transfers which increase energy losses. Energy stored in interior earth lateral panels thermal mass is given back to living space. Radiative heating effect due to hot water circulation in WEM panels embedded ducts helps to maintain ambience in the comfort zone.

Durant la période hivernale, pendant la nuit, les stores extérieurs sont abaissés afin de protéger l'enveloppe thermique des transferts radiatifs des vents froids qui augmentent les pertes d'énergie. L'énergie stockée dans la masse thermique des panneaux en terre latéraux est restituée vers l'espace de vie. L'effet de chauffage radiatif dû à l'eau chaude circulant dans les conduits intégrés des panneaux WEM aide à maintenir l'ambiance dans la zone de confort.

B Winter nights, passiv energetic strategy - Transversal section
 BA-003 Stratégie énergétique passive nuit en hiver - coupe transversale

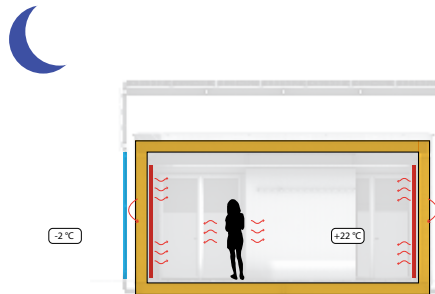

A Passiv energy strategies summer night, longitudinal section
 BA-005 Stratégies thermiques passives nuit en été, coupe longitudinale

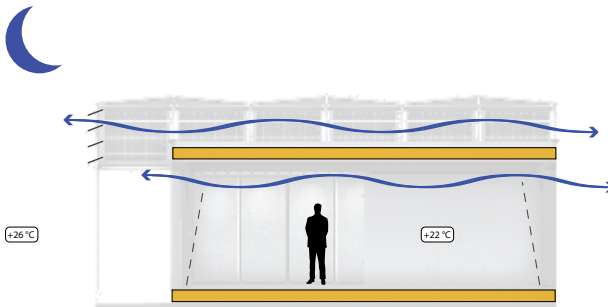

During summer nights, external blinds and solar screens are rolled up to allow for maximum radiative transfers. Walls can evacuate the heat. The separation of subroofing permits a ventilation of the vacuum under PV that helps to low their temperature down.

Durant la période estivale, pendant la nuit, les stores extérieurs sont relevés pour permettre de décharger les murs thermiquement. L'espace entre la toiture et la dalle permet une ventilation naturelle.

B Passiv energy strategies summer night, transversal section
 BA-005 Stratégies thermiques passives nuit en été, coupe transversale

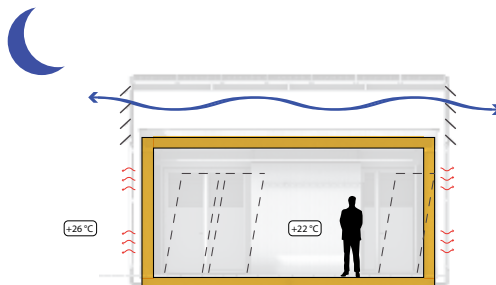

A Winter days passive energetic strategy - longitudinal section
 Stratégie énergétique passive journée en hiver - coupe longitudinale

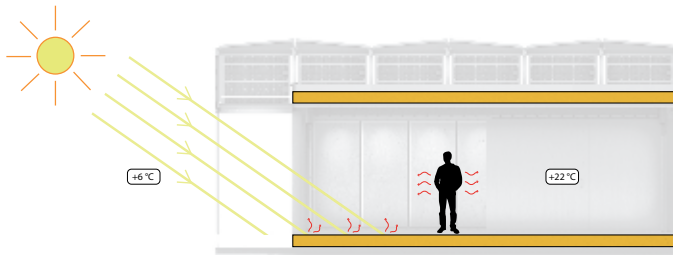

During winter days, external blinds are rolled up so that solar radiations can heat the house. Lateral earth radiant panels are warmed up by circulating hot water coming from NILAN VP 18 heat pump. Thermal insulation keeps temperature air inside and reduces energy losses to a minimum.

Durant la période hivernale, pendant la journée, les stores extérieurs sont relevés afin de pouvoir capter un maximum de rayonnements solaires. Les panneaux terre rayonnants latéraux sont chauffés par la circulation d'eau chaude provenant de la pompe à chaleur Nilan VP 18. L'isolation thermique performante de la maison permet de conserver l'air tempéré à l'intérieur et réduit les pertes d'énergie au minimum.

- Thermal envelop
- Solar radiation
- Heat radiation
- Thermal mass
- +6°C Average temperature

B Winter days passive energetic strategy - Transversal section.
 Stratégie énergétique passive journée en hiver - coupe transversale

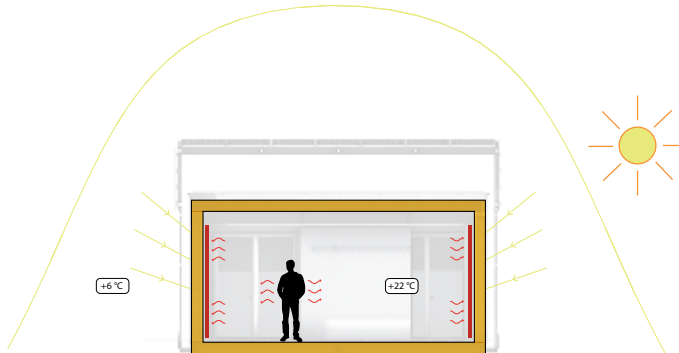

A Summer days energetic strategy - Longitudinal section
 Stratégie énergétique passive journée en été - coupe longitudinale

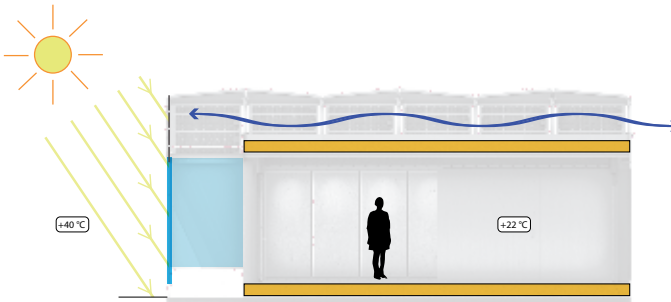

During summer days, external blinds and solar screens are rolled down to protect internal space from solar radiations heat gains. Bubendorff blinds can participate in the envelope thermal insulation when completely closed (siesta time). They can still provide daylight when louvers are angled at a 45° or horizontal position. In this case, their insulating effect is minor.

Lateral earth panels thermal mass participate in night time long cooling effect during daytime by being able to store calories. Insulated ceiling slab is completely shadowed by PV over roof and is not exposed to direct solar radiations. Natural ventilation of underroof space prevents from PV intradom' overheating.

Durant la période estivale, pendant la journée, les stores extérieurs sont abaissés afin de protéger l'enveloppe thermique du rayonnement solaire. La masse thermique permet de prolonger la fraîcheur de la nuit. La ventilation naturelle de la sous-face de la toiture PV permet d'éviter les échauffements dans le comble technique.

B Summer days energetic strategy - Transversal section
 Stratégie énergétique passive journée en été - coupe transversale

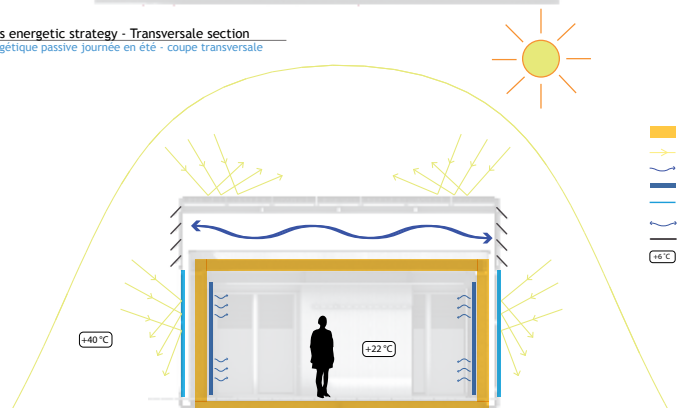

- Thermal envelop
- Solar radiation
- Freshness radiation
- Thermal mass
- Protecting blind
- Natural ventilation
- Under-roof natural ventilation
- Blind-sidest
- +40°C Average temperature

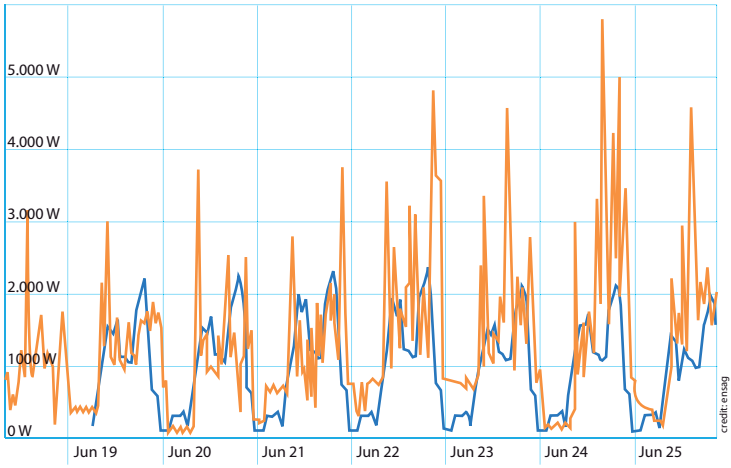

Electrical Consumption during the Competition Week. Simulations (blue) vs Measurement (orange). Wh

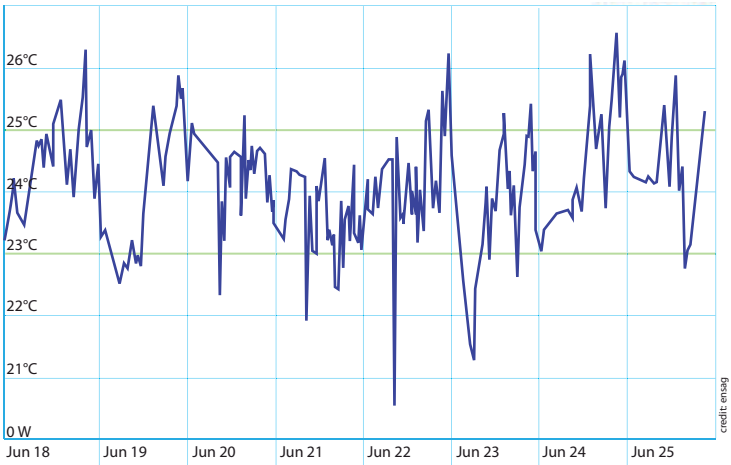

Indoor Temperature Conditions performance during the competition week. °C

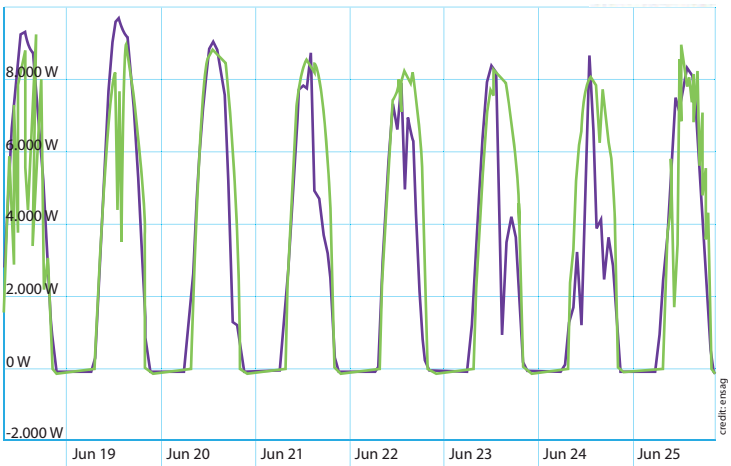

Photovoltaic Energy Generation during the Competition Week. Simulations (magenta) vs Measurement (green). Wh

TECHNICAL DATA OF THE HOUSE

Project name:
Armadillo Box

Construction area:
74,00 m²

Conditioned area:
44,67 m²

Conditioned Volume:
270,60 m³

ENERGY BALANCE

Estimated energy balance:
+14.160 kWh/a

CO₂ Emissions:
2.484 kgCO₂/a

Estimated energy production Madrid:
18.300 kWh/a

Photovoltaic system:
Total installed PV power:
13,8 kWp

Types of PV Modules:
Roof: 42 TENESOL TE2500 solar panels
East/West: 24 custom made TENESOL TEX853 solar blades
South: 7 TENESOL TE2500 solar panels
Inverters: 3 Schneider SunEzy 600E inverters

ENERGY CONSUMPTION

Estimated energy consumption Madrid:
4.140 kWh/a

Estimated electrical consumption Madrid:
90 kWh/m²a

Characterization of energy use:
Appliances + various electrical uses 3.179 kWh/a
HVAC+DHW 961 kWh/a

CONSTRUCTION ENVELOPE

Insulation types (type and thickness):

Type	Wood fiber	Glass fiber
Width (mm)	300	24-40
Thermal Conductivity (W/mK)	0,042	0.030

Constructive Systems thermal transmittance:

Opaque wall 0,16 W/m²K

Wall south 0,14 W/m²K

Glazing 0,80 W/m²K

Floor 0,122 W/m²K

Roof 0,156 W/m²K

COSTS

Construction Cost:
240.650 €

Industrialized Estimate Cost:
180.000 €

Luuku House

Aalto University, Helsinki, Finland

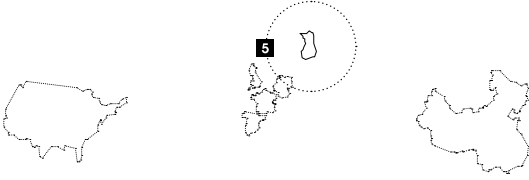

Nº.5 / 777,01 points

Contest 1: Architecture: 120,00 points.

Contest 2: Engineering and Construction: 59,00 points.

Contest 3: Solar Systems and Hot Water: 62,50 points.

Contest 4: Electrical Energy Balance: 112,62 points.

Contest 5: Comfort Conditions: 95,31 points.

Contest 6: Appliances and Functioning: 92,14 points.

Contest 7: Communication and Social Awareness: 53,30 points.

Contest 8: Industrialization and Market Viability: 41,00 points.

Contest 9: Innovation: 41,15 points.

Contest 10: Sustainability: 95,00 points.

Bonus Points and Penalties: 5,00 points.

Introduction and Main Objectives of the Project

The Luuku house represents a key step in the development of houses and construction techniques in Finland. We used wood as a primary building material, pre-fabrication techniques and a framing system of sheet materials. This way, the Luuku house responds to the challenges of building sustainably; our pioneering fabrication method is leading towards the future of design and represents great opportunities for development.

Our house responds to the solar environment. Its design integrates an appropriate orientation for solar gains, and shading so to prevent overheating.

Architectural Design

The primary architectural objective of our project was to build a wooden house. Wood is a very common material in Finland. It has an inherent low embodied energy. From the very early stages of the project, we wanted to create a design using natural and wood based materials in every application that permitted it.

Since our team is based in Finland, our products, technologies and materials have been sourced primarily throughout Finland, in order to reduce transport and fuel costs. We wanted to create not only a highly appealing housing product for the domestic market, but to achieve an exemplary model of the best Finnish design that would have a wider market appeal in terms of climatic, sustainable housing, and that could be implemented all over Europe.

Spatially, the design is divided in both longitudinal and transversal directions. Along with the kitchen, mechanical rooms and bathroom spaces are contained in a single, central core. The living and sleeping spaces are organized around this core (the former to the west and the latter to the east, along the longitudinal axis of the building).

Functionally, this allows a sleeping space with an apparent 'en suite' bathroom which provides privacy from the rest of the house, since it can be closed off behind the sliding door when guests visit. The galley kitchen, the most important part of the house, is located centrally. It is immediately visible from the entrance of the house, a few steps aside the eating space. It connects to the rest of the living space and to the 'living box', on the west cantilever of the house.

Aesthetically, we gave the house a "floating" appearance, and emphasized its light touch on the ground. This was achieved through a minimal landscaping covering the site; few points of contact where the house touches the ground, and through connecting the house with the greater landscape that surrounds it.

Behind thickset walls, the interior spaces of the house show a natural, progressive alignment. Such movement is emphasized by an angled roof which slopes from the entrance to the back of the house. The linear alignment of the materials as well as floor and ceiling finishes naturally lead along the east-west axis of the house. We focused on the aesthetics of details, so to create a harmony between the user and the home. We strongly

believe that detailing emphasizes the best qualities of each material, on both the interior and exterior faces of the house. Equally, it was very important to us that each material was given a human scale: each board, each space "in-between", and each surface connect the inside to the outside, in relationship with the environment of the Luuku house.

Construction and Materials

One of the main architectural goals of the Luuku house was to utilize wood and wood based materials in as many applications as possible. Part of the engineering concept was to use the inherent technical properties of wood in new, innovative ways. We developed new structural methodologies proving that timber, for example, can replace vapor barriers and be used for temperature and humidity buffering.

We developed glazing technology and gluing techniques for glazing panes, creating frameless solutions for both windows and doors. These high performance solutions have low U-values and show an excellent thermal performance, creating opportunities for future engineering developments on these topics.

We also developed further the acoustic buffering systems of ventilation units. The design our HVAC team proposed reduces the sound levels emitted by the everyday operation of these systems.

Humidity control. We used two different methods for controlling humidity. First, we could minimize the amount of mechanical energy required to control moisture levels in the building by using wood based products. The second one was to use a rotating heat recovery system.

Moisture buffering - background to the research.

Wood is a hygroscopic material, which means that it absorbs and desorbs humidity. This phenomenon, called moisture buffering, can be utilized to reduce daily moisture variations in a building. Moisture buffering keeps indoor's relative humidity (RH) at a more stable level.

Our hypothesis was that moisture buffering could help stabilize the humidity in our house, and that its effect could be enhanced by using untreated, sawn wood. We evaluated that different panel profiles (finger, wave, etc.) might be a good solution, because they provide a larger active area. We didn't know how strong a buffering effect was needed to maintain a targeted relative humidity level of 40-55 %. We decided to maximize the surface covered by moisture buffering wood products in the interior. We assumed that the interior wooden surfaces would require a protective coating likely to reduce the moisture buffering effect.

Phase changing materials. One of our biggest engineering challenges was to create a house that will maintain comfortable temperature levels for both extreme weather conditions, as of Madrid in the summertime, and Finland in the wintertime. The framework of the house is manufactured out of Kerto-Q boards; the interior and exterior are upholstered with wood. The low mass of the structure brings problems when it comes to heat energy. The light structure cannot maintain the balance in the way that massive structures do.

We examined different PCM solutions for the Solar Decathlon competition house. Phase changing materials are generally used to keep fragile materials, such as organs in transportation for example, at the correct temperature for an extended period of time. PCM materials are also used in electronics when components need to be kept at a certain temperature without cooling. Suitable applications of PCM for construction techniques, however, still remain very few. The technology is new; it is not commonly used and remains underdeveloped. The markets and new energy efficiency directives will most likely enhance the demand. The most suitable, existing PCM application for buildings is interior boards, which we used for our prototype.

Interior Comfort, HVAC and House Systems

Thus, we privileged bioclimatic strategies over strictly technological approaches. Our primary objective was to favor passive techniques over 'semi-passive' and active systems.

We chose air heating and cooling, because they require a low heating and cooling power. With a high energy recovery efficiency of 85% gained from re-circulating the air through heat exchangers, energy is not wasted. The system also presents the advantage of responding to changes in the interior environment very quickly.

Air conditioning consists of a ventilation unit and a recirculation air unit. Fresh air is taken from the north side wall of the building. The fresh air flows through an efficient heat recovery wheel which recovers heat from the exhaust air, heating the fresh air. When cooling, and indoor air is cooler than outdoor air, heat recovery operates conversely cooling the fresh air. The annual efficiency of the heat recovery is 78,5 %.

After going through the ventilation unit, the air flows through a recirculation air unit and is blown into the living room area. Due to the position of these units, only one supply air fan and one exhaust air fan are needed. The supply air fan is located in the recirculation air unit and the exhaust air fan is located in the ventilation unit.

Recirculation air is taken from the bedroom area. Recirculation air is used only when heating or cooling is needed in the house. Recirculation air enables a high cooling and heating power with a relatively low energy input. An air heat pump is integrated into the recirculation air unit, which cools or heats the supply air when needed. The outdoor unit of the heat pump is positioned under the deck area. Exhaust air is taken from the bathroom, kitchen and technical space. In some cases, the air flow of the ventilation unit is raised. The maximum air flow of the ventilation unit is 70 l/s. However, the average air flow is +25 / -30 l/s. With recirculation air, the air flow can be raised up to 200 l/s. The highest heating power is 2200 W when supply air temperature is +31 °C. Correspondingly, the highest cooling power is 1800 W when supply air temperature is +16 °C. The recirculation air flow rate is 140 l/s with a typical cooling load.

A kitchen hood is located above the stove. The exhaust fan of the hood is positioned immediately above it. All the exhaust air, from the ventilation unit and the kitchen

hood, is blown out from the roof. Air conditioning can be operated with an indoor temperature based control and an indoor carbon dioxide level based control at the same time. Night cooling is also possible and controlled by the automation of the system.

The user can also control the air condition by increasing or decreasing the air flow. Time based programs and present, away pre-set programs can also be controlled by the user.

Hydrothermal comfort. Domestic hot water is mixed with a mechanical mixing valve. Water temperature can be adjusted between 45 and 65°C. All faucets react automatically to fluctuations in water pressure and temperature, balancing them constantly.

Ventilation and air quality. Outdoor air flow is regulated by carbon dioxide concentration and varies between 25 – 70 l/s. The air exchange rate is 0,86 1/h (25 l/s) and 2,4 1/h (70 l/s) so carbon dioxide concentration stays below 800ppm. When cooling, recirculation air temperature is 16°C; when heating, the air temperature is 31 °C. Air velocity (see figure 1) does not exceed 0,20m/s in the living area. Outdoor air is filtered with high quality filters.

Solar Systems

We designed the photovoltaic system in collaboration with Naps Systems Oy. Naps Systems provided the systems components, which we installed under their supervision with certified electrician(s).

The main components of the photovoltaic (PV) systems are photovoltaic arrays and grid-connected inverters. At any time during the day, the PV array can produce electrical power according to the amount of daylight it receives at that moment. Other factors, which determine the amount of power produced, include the temperature of the PV array and the voltage at which it is loaded.

The PV array consists of three groups of PV modules, each one having:

1. Set of modules

2. DC connection box including surge protection devices
3. Inverter SB3000
4. AC switch including circuit breaker

Naps Systems designs two types of modules: Saana 245 GDM PnB (~1,6m²) and Pallas 220 GDM PnB (~1,45m²). These modules are frameless since as we said before, our competition team wanted to use wooden framing and attachment methods to reduce ecological footprint. Mechanically equivalent framed modules of Naps Systems (NP200 and NP230 series) are IEC61215 and IEC61730-1 and -2 certified (certification including the junction boxes used). The PV panels have 54 or 60 monocrystalline silicon solar cells in series. Under standard test conditions of 1 kW/sq m solar irradiance (Air Mass 1.5) and 25°C cell temperature, they typically give a maximum power of 220 and 235W respectively. Under factory test conditions, the standard module efficiency is of 15,4 %. The solar cells themselves, under such conditions, are 17% efficient. These efficiencies are only useful for comparing PV modules and cells with one another, and are not to be used for accurate prediction of the module output in field conditions. Our calculation program takes into account the precise effects of irradiance and temperature on actual module output.

The chart below shows the electrical properties of the three PV groups:

Electrical properties of the three PV groups:			
	Group 1	Group 2	Group 3
Module	NP245/60	NP245/60	mixed
Amount	12	12	14
Voc	448,8	448,8	479,2
Isc	9,05	9,05	9,04
Pm	2940	2940	3130,0
Vm	346,8	346,8	369,8
Im	8,48	8,48	8,46
I@230V	12,78261	12,78261	13,6087

The sum of the three PV groups gives us 9.01kWp total nominal power and 39.17A total nominal current to 1-phase grid.



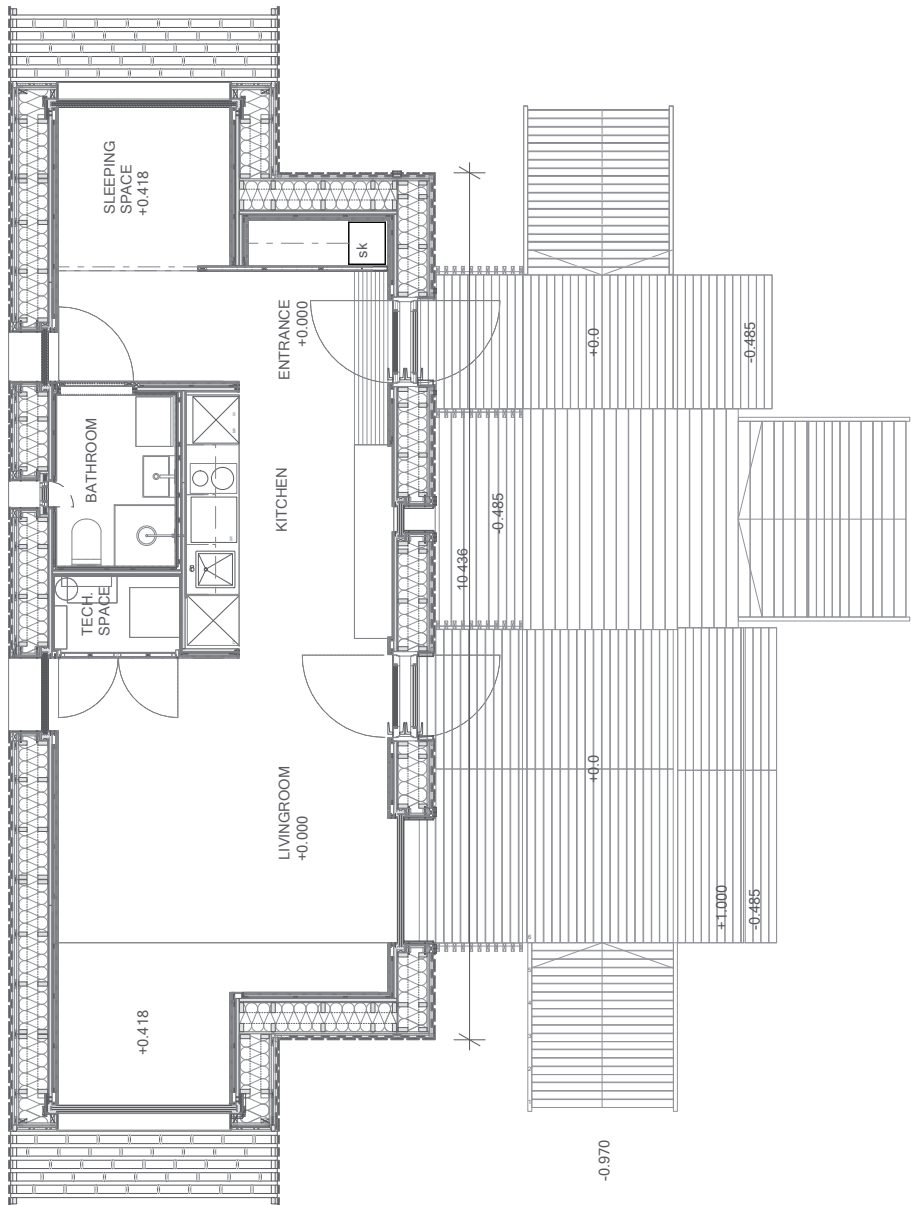

Floor plan



North site elevation

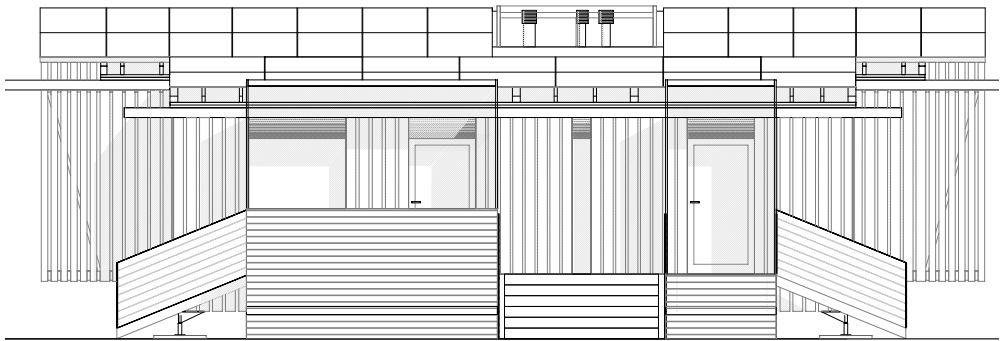

South site elevation

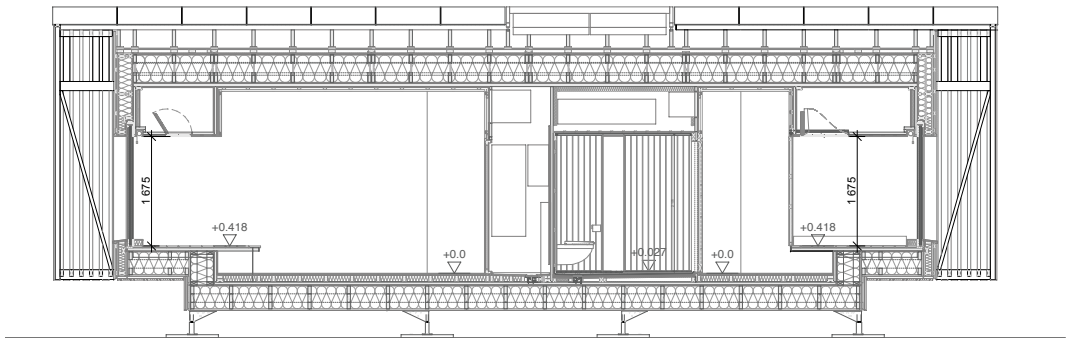

Longitudinal section

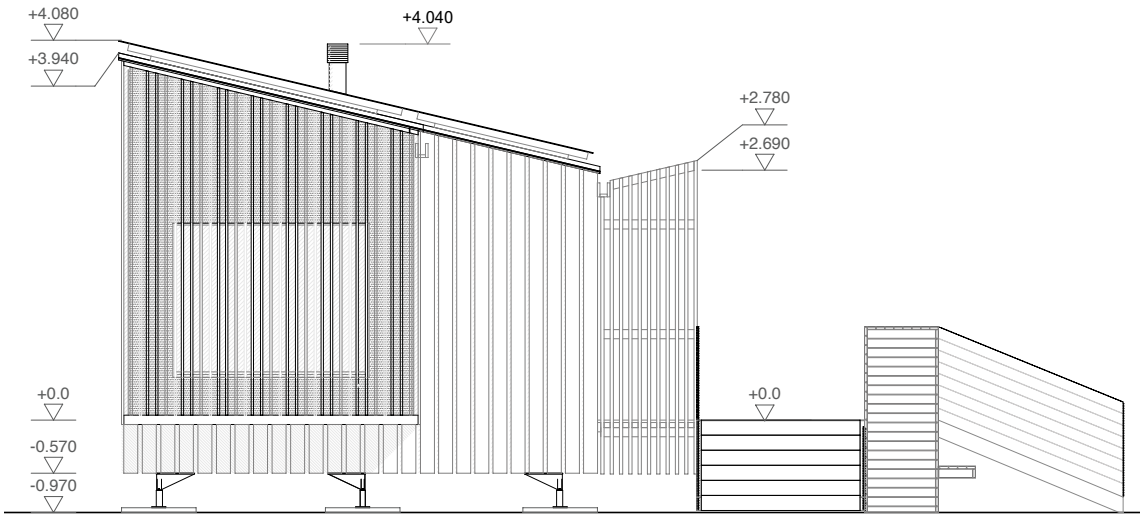

West site elevation

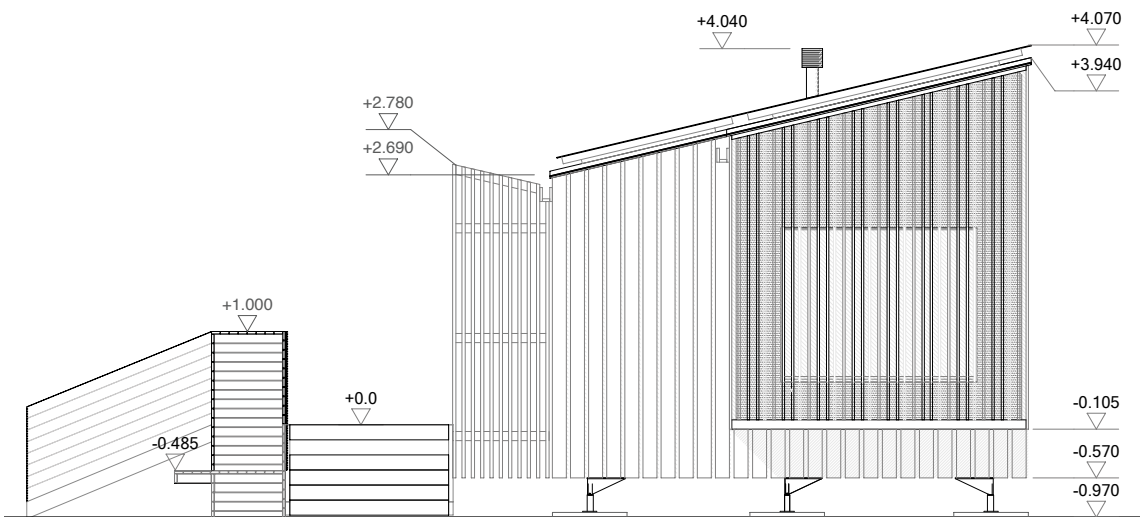

East site elevation

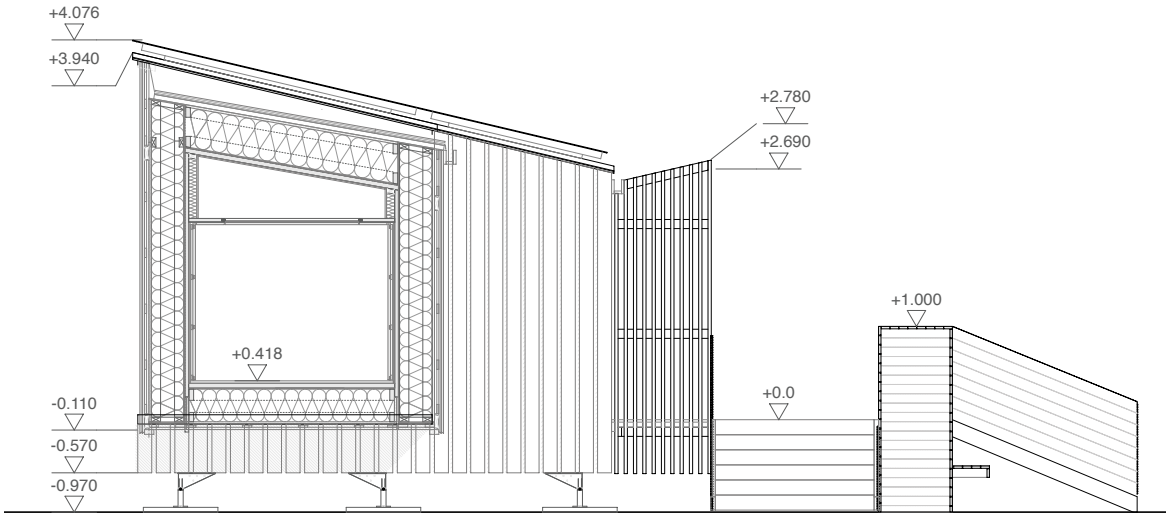

Transversal section 1

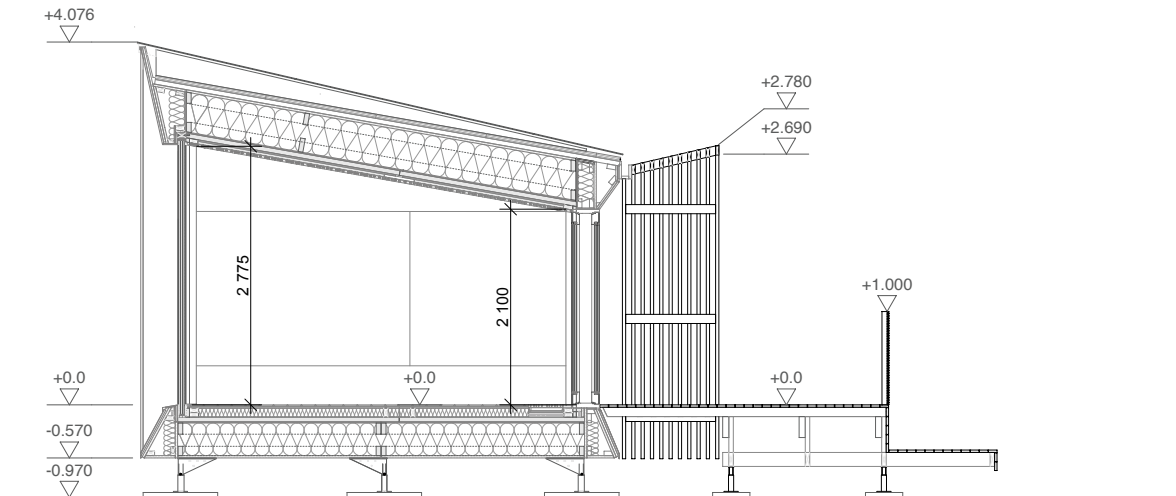

Transversal section 2

TECHNICAL DATA OF THE HOUSE

Project name:

Luuku House

Construction area:

60,60 m²

Conditioned area:

42,40 m²

Conditioned Volume:

242,40 m³

ENERGY BALANCE

Estimated energy balance:

+8.171 kWh/a

CO₂ Emissions:

3.360 kgCO₂/a

Estimated energy production Madrid:

13.771 kWh/a

Photovoltaic system:

Total installed PV power:

9.0 kWp

Types of PV Modules:

Roof: 59 m² of monocrystalline photovoltaic panels.

Naps Module Pallas 220GDM PnB

Inverters: SunnyBoy SB 3000TL HC

ENERGY CONSUMPTION

Estimated energy consumption Madrid:

5.600 kWh/a

Estimated electrical consumption Madrid:

132,07 kWh/m²a

Characterization of energy use:

Appliances+various electrical uses 1.736 kWh/a

Space heating 105 kWh/a

Space cooling 568 kWh/a

DHW 2.236 kWh/a

Lighting 178 kWh/a

Fan/pumps 577 kWh/a

Information provided by the university

CONSTRUCTION ENVELOPE

Insulation types (type and thickness):

Type	Fibreboard	Cellulose	Fibreboard
Branch	Suomen Kuitulevy	Vital	Suomen Kuitulevy
Model	Lion	Vital 040	Lion
Thickness (mm)	12	350	25
Thermal conductivity (W/mK)	0,054	0,037	0,054

Constructive Systems thermal transmittance:

Wall 0,1 W/m²K

Floor 0,08 W/m²K

Glazing 0,30 W/m²K

Roof 0,08 W/m²K

COSTS

Construction Cost:

496.000 €

Industrialized Estimate Cost:

180.000 €

Team Wuppertal

Bergische Universität Wuppertal, Germany

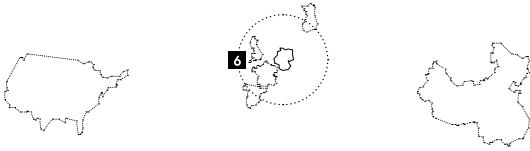

Nº.6 / 772,72 points

Contest 1: Architecture: 108,00 points.

Contest 2: Engineering and Construction: 59,00 points.

Contest 3: Solar Systems and Hot Water: 64,46 points.

Contest 4: Electrical Energy Balance: 114,02 points.

Contest 5: Comfort Conditions: 75,57 points.

Contest 6: Appliances and Functioning: 115,17points.

Contest 7: Communication and Social Awareness: 40,00 points.

Contest 8: Industrialization and Market Viability: 52,70points.

Contest 9: Innovation: 44,80 points.

Contest 10: Sustainability: 95,00points.

Bonus Points and Penalties: 4,00 points.

Introduction and Main Objectives of the Project

The goal of our design is to form a harmonious entity by integrating the determining factors of the design, namely functionality, aesthetics, technology and space in an experimental way. Our project takes sustainability as a central issue of our times, and seeks to adapt it to the modern ways of living in "European houses".

The key idea of our design reflects human beings simultaneously understood as both individuals and members of their society - in the very ways in which they perceive and relate to their surroundings. The house can thus function as a solitary object, or be integrated as part of an urban cluster.

The house and its outdoor spaces occupies an area of 13.00 m x 23.20 m with a maximum height of 5.45 m, including a 0.50 m plinth. Two active-solar, thematically differentiated walls accompany the roof space (a 74 m² floor flowing from east to west). The living area is about 50 m²; it is located between the two active-solar walls, and can be extended towards the east or the west by opening the sliding panels giving access to the terraces. Based on this fundamental principle, the house can be flexibly adapted to the varying needs of the occupants: it is a flowing space.

The space and its mobile furniture is understood as a free "playground". The boundaries between the inside and outside are blurred. The mobile furniture allow multiple, overlapping functions within a relatively small, open area.

Architectural Design

The basic idea behind the design is the "European house" in its energy-relevant sense, but also and even more so, in its cultural sense.

In Western industrialized countries, changes affecting the structure of the traditional family -as well as demographics in general- are currently observed. In terms of housing, open, flowing rooms, in which different spaces, with the help of flexible furnishing, can be configured according shifting situations and uses are of trend.

Consequently, fewer materials are used; they are selected on the basis of their relation to each other, as well as according to their overall sustainability. The textile-clad facade and the draped curtain appear as a soft garment. Inside and outside areas are divided by light-weight walls, and accentuated with yellow highlights, complement the tactile and optical qualities of the wooden floor, which overall enhances the "flowing" feeling of the room.

Exterior. Solar walls. In a way, solar walls are a metaphor of our entire design. They define the flow of the room from east to west (as a three-dimensional element) and integrate active solar surfaces such as photovoltaic and solar-thermal elements as a design measure. The southern wall is dominated by an abstract image representing the dynamics of solar energy, composed of differentially colored photovoltaic modules. By contrast, the northern wall is dominated by a graphic design which

is coherent with the southern wall. Portraits of our team members and of our external partners represent the creative process and the social interactions of extremely different people from very different backgrounds which inspired our project.

Exterior. Sliding glass doors and curtain system. Sliding glass doors allow the controlled conditions of the indoor rooms to be maintained while completely opening to the outdoor, creating a space continuum. The living space is thus extended considerably. A semi-transparent curtain system filters the light, providing shading and the necessary privacy for the occupants. The sliding panels and the curtain were designed especially for the competition.

Exterior. Terraces. The two terraces are conceived as an extension of the living spaces. Mobile glazing elements are complemented by the mobile furniture of the indoor space.

The eastern terrace features a seating sculpture which protects the space and serves as an entrance to the house. The western terrace, by contrast, has a more private character, with its plants, strip of water and elements for relaxation.

Exterior. Patio. The patio on the upper storey provide a belvedere protecting the residents against the glaze of outsiders. The lounge-like surroundings of this area allow the occupants to carry domestic activities in an intimate atmosphere, under an open sky. Such a setting takes the notion of "experimental living" a step further.

Interior. SmartBox. The SmartBox is the center and the multi-functional heart of our space. It combines all domestic functions such as sleeping, personal hygiene, working, entertainment, seating and storage. The central element of the service technology, the compact ventilation unit, is also located in the SmartBox. The two-storey structure allows optimal usage of a minimal floor area. By folding down, rotating or drawing out single elements such as the bed-sofa, the desks, the several cupboards, the integrated shelf or the "playing field" of the upper zone, a great variety of functionalities can be

achieved. The patterns created by the joints between the white surfaces of the box as well as the strong colors accentuating the internal elements underline the operating principle of the individual elements.

The box also includes a zone for personal hygiene: a spa opens up to the exterior, and merges with the pond to form a strip of water.

Construction and Materials

Constructive design. The whole "building-open-space-unit" of our house is designed for assembly from a few transportable prefabricated segments in timber skeleton and panel construction. The sizes of the elements were determined by the loading capacity of the transport vehicles and the weight of each element during assembly. In order to ease the transportation, we chose a system of flat elements. All elements combine structural timber and insulated timber profiles with thermal insulation covered by a skin of OSB, which also functions as cross bracing. The interior fittings such as the kitchen and multi-use cube are segmented into units maximized for transportation, and inserted into the house by crane before closing the roof.

Structural design. Every part of the structure is designed as part of the building skin. The two main walls of the house (north and south) are also the load-bearing elements. The east and west side opens to the terrace on level 0 without any supporting columns. This is possible by the use of high slender beams made of laminated timber, with a structural thickness of only 9 cm. They span the 13 m between the north and south walls and support the roof and patio. The structure is made of FSC certified timbers.

The envelope of the building combines passive and active aspects to supplement the technical infrastructure described above.

Every parts of the envelope of the building are highly insulated, closed elements. They have an U-Value of 0,1 W/(m²K) or better; windows and openings have an U-Value of 0,8 W/(m²K). This is achieved by a thick layer of

highly efficient glass wool in the layer of the structural elements, supplemented by vacuum insulation panels in areas of solid structural elements and thermal bridges. All glazing is gas filled triple glazing in timber frames.

Interior Comfort, HVAC and House Systems

Interior comfort. In addition to its positive energy balance, our design aims at maximizing the comfort conditions inside the house within varying climatic conditions, and this, in locations as different as Wuppertal or Madrid. The envelope design and construction follow the idea of a so-called "passive house": indoor comfort is - independently of the site location - mainly gained by a high-performance envelope, which is only assisted by minimized active heating and cooling. The timber beams are insulated with a 8 cm vacuum insulation and the eight sliding doors, with low triple glazing and insulated timber frames. These are good examples of the innovative solutions we proposed. Air-tight closure of the large doors is a newly designed feature that ensures the level of air tightness needed to effectively run a mechanical ventilation system with heat recovery. During the summer, solar cooling loads are kept low with an external curtain. The aluminized fabric reduces solar gain by 90%, while maintaining its transparency.

Phase change material (PCM), based on a salt hydrate and located between the Kerto board and the acoustic panel, increases the thermal capacity and helps reducing thermal peak loads. The PCM storage capacity is regenerated by night ventilation.

Natural and artificial lighting. The key design issue we used in designing the natural and artificial lighting of the house is inspired by the different levels of the human perception. The general atmosphere; understanding the room as the backdrop of domestic activities; principles such as innovation, technology, efficiency and interaction are all essential aspects here.

Horizontal daylight is filtered by a curtain. It gently bathes the room with an even light. By contrast, the light which enters vertically the window from the patio accentuates the forms in the room with strong patterns.

This "two-tone light chord" sensitizes the occupant's eye, making him more perceptually conscious of the ambient architecture.

Artificial lighting is based on energy-efficient light-emitting diodes (LED). An innovative, user-responsive lighting concept in the form of a light ceiling was developed specifically for the competition. Sensors of the lighting system detect the occupants' movement inside the room, and adapt the lighting to the various situations and atmospheres of domestic life. User's awareness is thus concentrated on the corresponding activities. At significant points of the house, additional "light piercing" contributes to the design. By contrast, outdoor lighting is conceived as a "guiding medium".

Solar Systems

PV system. The collection of solar energy is concentrated on the flat roof and the two solar walls. 27 highly efficient photovoltaic (PV) modules form a V-shaped structure on the water-draining roof with a slope of 6° east and 3° west. The custom-designed 115 modules of the south facade correspond to the curtain facade, with individual elements facing on the north.

The system is connected to the grid by a so-called "switch box" allowing the house to operate in fully grid-connected, as well as battery-buffered, and occasionally stand-alone modes. Three transformerless inverters - two for the roof, one for the facade with its two strings - connect to the switch box as well as a back-up inverter and the grid. The switch box, together with the 5 kW back-up inverter, optimizes the use of a 7.2 kWh (48 VDC) battery bank with four 150 Ah fully encapsulated gel batteries. The energy management system is designed to - preferably - cover the electricity demand of the house by its own solar energy generation using the batteries as short-term buffer capacity. All inverters are located within the solar wall, directly behind the PV generator.

Thermal solar system. The solar thermal system is an integrated part of the northern solar wall. 6 m² high performance vacuum tube collectors are connected to the compact HVAC center of the house. The vacuum tube

collectors operate according to the heat pipe principle. The 250 liter storage tanks of the compact unit link the solar gain to the back-up system based on a heat pump. The solar collectors and the heat pump use the same in-tank heat exchanger. Peak demands may be met by a resistance heater in the top section of the storage tank.

The solar gains are utilized on demand for DHW as well as air and floor heating.

In contrast with a fully PV-based solar energy system, the use of solar thermal collectors helps to reduce the electric peak loads and the mismatch between the electricity demand and solar electricity supply. Peak loads for the public grid are reduced.

The total annual collector yield is estimated to 2.5 MWh under Madrid's climatic conditions (the conditions of the competition for DHW withdrawal and space heating needs). This corresponds to a solar fraction of 76%.

Singular and Special Systems or House Elements

Multifunctional and compact solutions: The HVAC/DHW unit. The so-called "compact unit" functions as a logical supplement to the architecture. It is integrated into the interior design ("Smart Box") and provides a high technical standard as well as a high degree of user friendliness. The compact unit provides heating, cooling, ventilation and hot water with all the control needed. The main energy source is a heat pump assisted by a solar thermal system. The air-based heat pump operates between waste air and supply air using a hydraulic switch to pass from heating to the cooling mode. A highly efficient heat exchanger allows more than 80% of the ventilation heat to be recovered (winter). It also allows effective cooling of the supply air by transferring heat to evaporate water in the exhaust air (summer). We developed the indirect adiabatic cooling in the context of the competition. The total unit work together with the 6 m² solar thermal system. Air cooling and heating is assisted by a floor-mounted hydraulic system keeping the air flow rates and the power consumption of the fans low. This floor-mounted cooling and heating system is constructed in a lightweight design which makes it faster to control. The compact dimensions,

together with the advantage of a ready-to-use system with integrated control guarantees, easy the installation and helps minimizing the installation volume in a compact building. Although the controls are completely autonomous, we connected the compact unit to the central building automation and control system, for monitoring and data visualization.



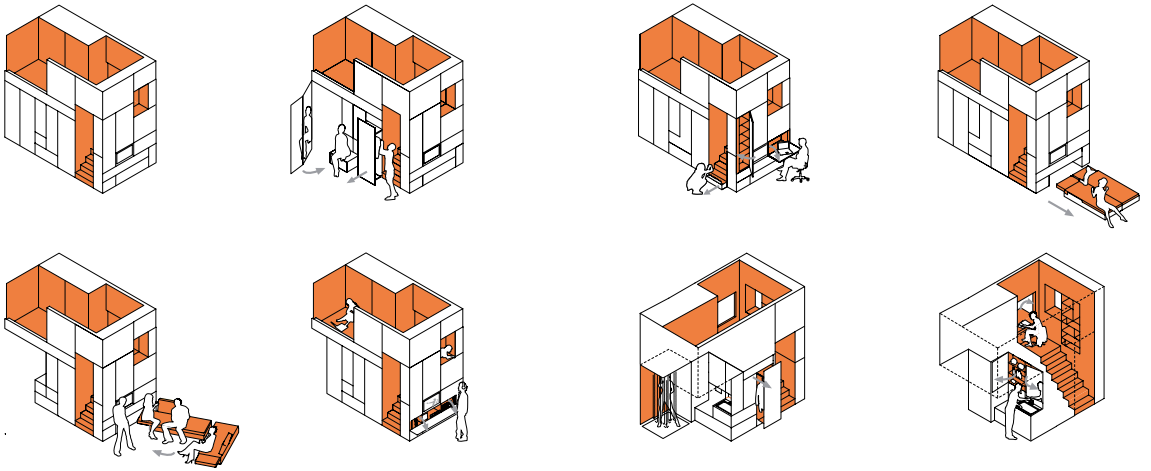

Different solutions

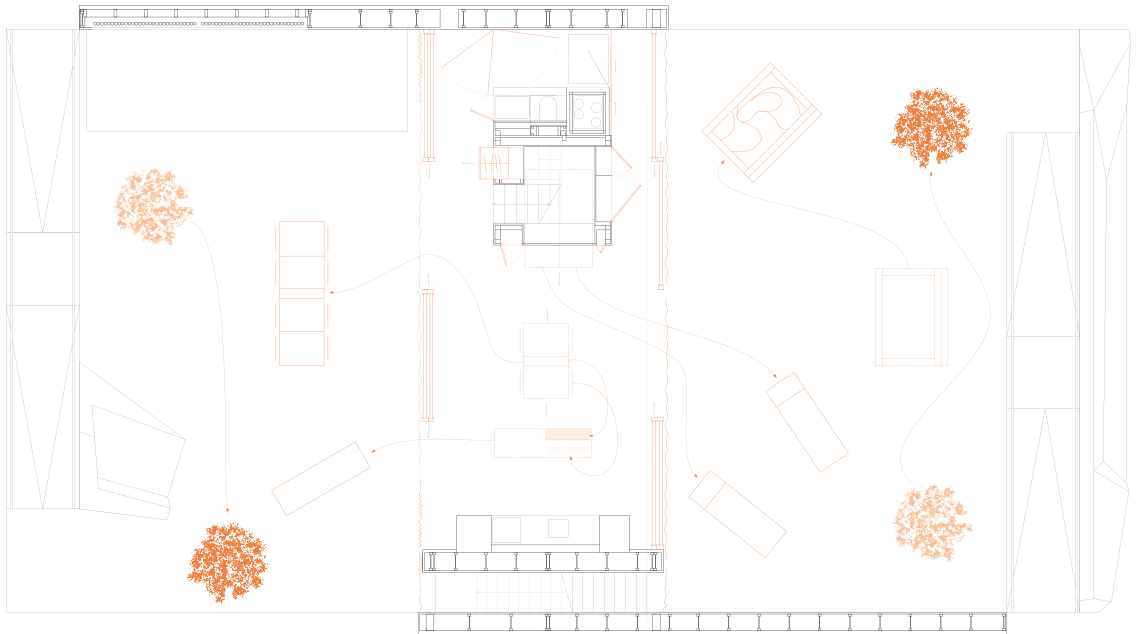

Floor plan

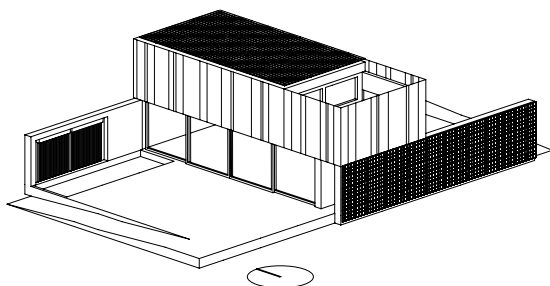
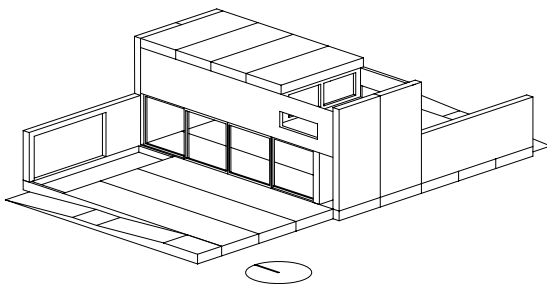
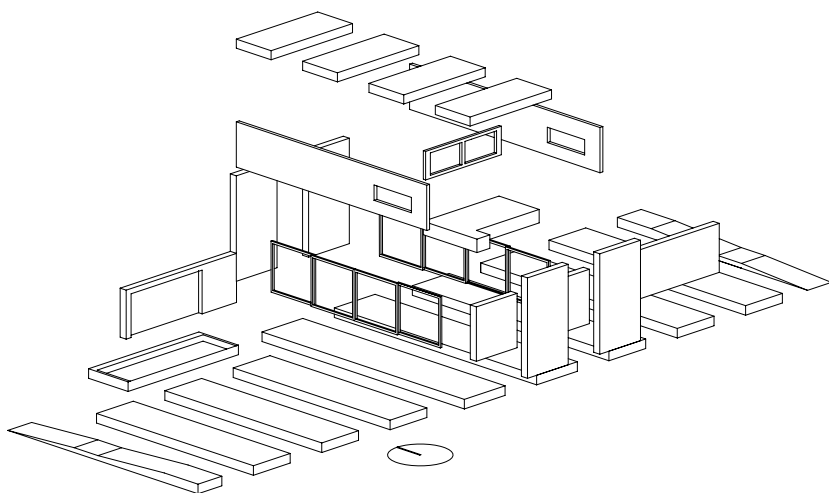

Assembly isometry

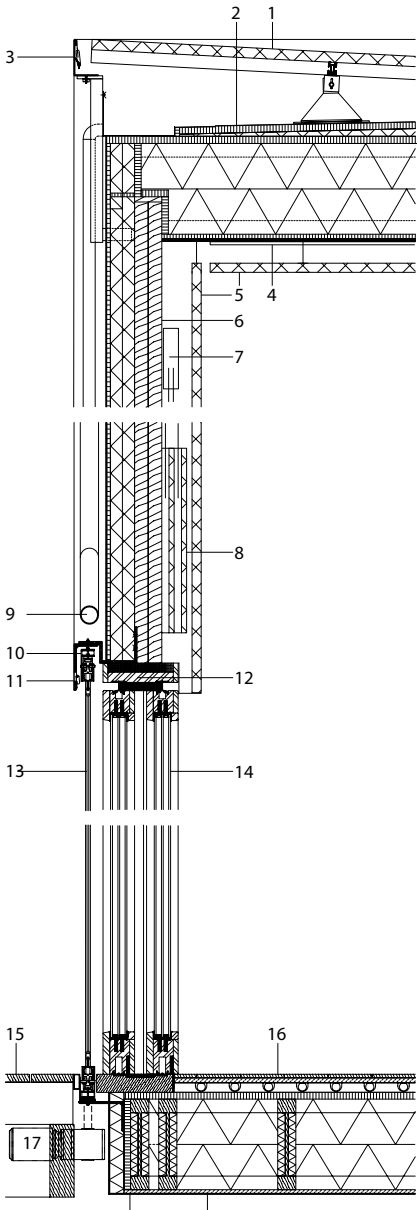

- 1 photovoltaic 27 modules (1675/1001/31 mm)
on substructure with adjustable feet
- 2 roof structure:
roof sheeting
oriented strand board 22 mm
gradient insulation, blow-in insulation cellulose fiber (HCG 040) 10 - 58 mm
oriented strand board 22 mm
insulation mineral wool (HCG 032) 300 mm
I-Joist 300 mm
oriented strand board 15 mm
gypsum plaster fiberboard 9,5 mm
- 3 steel section, attachment textile facade 120/80/8 mm
- 4 lighting ceiling with 36 LED-modules (9,5 W per module) 92/92 mm
- 5 translucente acoustic panels, polycarbonate multi-wall sheet micro perforated surface 30 mm
- 6 wall structure:
veneer composite lumber (Kerto) 2x 45 mm
vacuum insulation (4-ply) 80 mm
oriented strand board 12 mm
moisture barrier
aluminized textile
- 7 supply air duct 5/20 mm
- 8 PCM 2,7 kJ/kgK
- 9 down spout
- 10 guidance curtain
- 11 steel section substructure 153/80/8 mm
- 12 embrasure, core insulated solid wooden section Thermowood BU 224/56 mm
- 13 shading:
moveable curtain, aluminized textile: $F_c = 0,7$
- 14 sliding door: $U_w = 0,9 \text{ W/m}^2\text{K}$
frame solid wood Thermowood BU 98/65 mm
 $U_f = 1,0 \text{ W/m}^2\text{K}$
triple-pane window, 6/16/4/16/4 mm
toughened safety glass or float glass filling with argon
 $U_G = 0,58 \text{ W/m}^2\text{K}$
- 15 terrace:
floor board Thermowood BU 26 mm
substructure Thermowood 80/100 mm
supporting structure Thermowood 100/220 mm
- 16 floor structure:
floor board, parquet Thermowood BU 12 mm
wooden fiber cement board 16 mm
floor heating/cooling 30 mm
moisture barrier
oriented strand board 22 mm
insulation mineral wool (HCG 032) 300 mm
I-Joist 300 mm
cement bound panel 12 mm
saking foil
- 17 engine for curtain activity

Detailed wall section

TECHNICAL DATA OF THE HOUSE

Project name:
Team Wuppertal

Construction area:
73,80 m²

Conditioned area:
48,55 m²

Conditioned Volume:
315,5 m³

ENERGY BALANCE

Estimated energy balance:

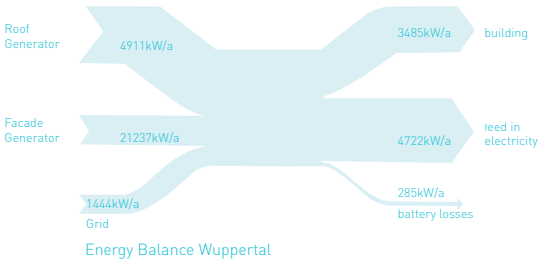
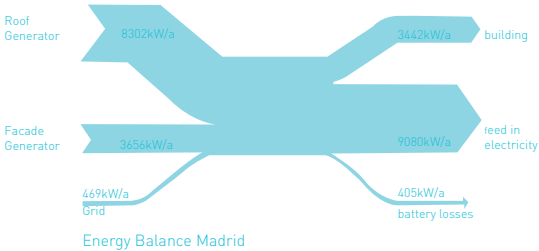

Emission credits:
5.602,4 kgCO₂/kWha
 Emission consumption:
965 kgCO₂/kWha

Estimated energy production Madrid:
12.927 kWh/a
 Estimated energy production Wuppertal:
8.492 kWh/a

Annual total electricity generation Madrid:
12.927kW/a

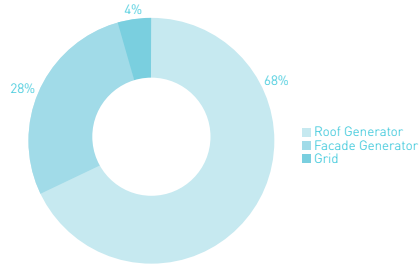

Annual total electricity generation Wuppertal:
8.492kW/a

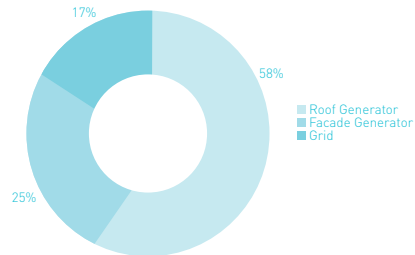

Photovoltaic system:
 Total installed PV power:
10,1 kWp

Installed PV power façade:

3,5 kWp

Installed PV power roof:

6,6 kWp

Types of PV Modules:

Roof: 59 m² of monocrystalline photovoltaic panels.

Naps Module Pallas 220GDM PnB

Inverters: SunnyBoy SB 3000TL HC

ENERGY CONSUMPTION

Estimated energy consumption Madrid:
3.442 kWh/a

Estimated energy consumption Wuppertal:
3.485 kWh/a

Estimated electrical consumption Madrid:
70,89 kWh/m²a

Estimated electrical consumption Wuppertal:
71,78 kWh/m²a

Characterization of energy use:

Annual total electricity generation Madrid:
3.442kW/a

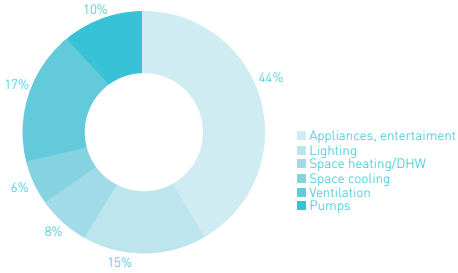

Annual total electricity generation Wuppertal:
3.485kW/a

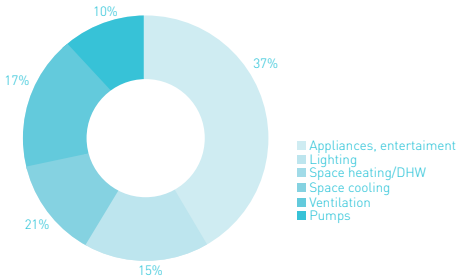

CONSTRUCTION ENVELOPE

Insulation types (type and thickness):
insulation glass wool 30cm (roof, floor, north and south wall)
vacuum insulation 8cm (west and east wall)

Constructive Systems thermal transmittance:
North and south wall 0,1 W/m²K
East and west wall 0,09 W/m²K
Floor 0,11 W/m²K
Roof 0,09 W/m²K

Information provided by the university

COSTS

Construction Cost:

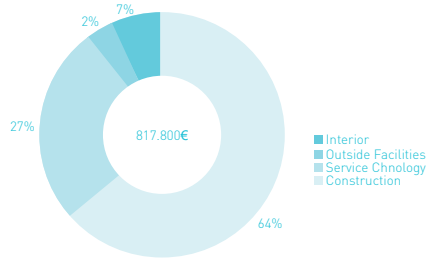

Break down construction cost according to Din 276, including VAT 19%

Industrialized Estimate Cost:

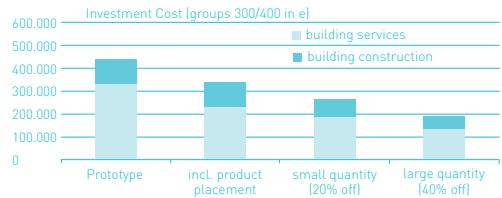

Trend of costs by different measures

Napevomo

Arts et Métiers ParisTech, Bordeaux, France



N°.7 / 762,67 points

Contest 1: Architecture: 72,00 points.

Contest 2: Engineering and Construction: 66,00 points.

Contest 3: Solar Systems and Hot Water: 68,25 points.

Contest 4: Electrical Energy Balance: 110,48 points.

Contest 5: Comfort Conditions: 102,99 points.

Contest 6: Appliances and Functioning: 112,75 points.

Contest 7: Communication and Social Awareness: 21,80 points.

Contest 8: Industrialization and Market Viability: 35,70 points.

Contest 9: Innovation: 47,70 points.

Contest 10: Sustainability: 120,00 points.

Bonus Points and Penalties: 5,00 points

Introduction and Main Objectives of the Project

Inside or outside the competition, the objectives of our project were clear since the beginning. Prefab homebuilding is undergoing a revival. In its new incarnation, "green" prefab promises to be an efficient way of building a high-quality, energy-conserving home with smart, earth-friendly materials. We wondered if ready-to-assemble structures are able to produce a house that evolves, understands, and adapts to every lifestyle, within a wide range of tastes and dreams. The idea seemed ambitious, yet this was the goal of the Napevomo project. Napevomo comes from the Cheyenne language *Nápévomó*, which signifies "do you feel well?". It is an homage to the profound respect for nature of Native American people. Our home aims to be intelligent, owner-compatible, and have a low ecological footprint.

Designing and building a structure that is both energetically and environmentally efficient requires a well thought, integrated approach in defining the various components. The Napevomo house combines bioclimatic architecture, the use of natural construction materials and local resources, and the development of advanced technologies for energy production and management. In doing so, our prototype contributes to the development of practical ideas for the "house of tomorrow". It also provides key concepts in terms of recycling waste water.

Architectural Design

The architectural design of Napevomo is the result of co-conception process: engineering and architecture students worked with a professional architect. The primary objectives and common goal of the design team were to build a comfortable house with a low environmental impact on most aspects of its whole life cycle.

Our whole architectural concept is based on well-being. We are convinced that it is a key concept for designing sustainable houses with a high level of comfort, while respecting the environment. Well-being, as a combination of emotional interactions with the environment – social and natural – has a lot to do with connections and intimacy.

Exterior design. The overall design is derived from our initial concept, and from one main natural element: the sun. The relationship between the house and the sun is ambiguous, and changes with the seasons. Our solar passive house takes advantage of the sun during the winter, and protects from it during the summer, while capturing solar energy to produce electricity and domestic hot water. Moreover, Napevomo integrates some challenging technological elements such as a rather large solar concentrator. Our design plays with curves. This way, we could integrate technologic and sun exposure elements into a coherent architectural concept.

Interior design. The interior of the house can be seen

as a 'natural habitat', providing both protection and connection to the outer environment. Like a nest or a cocoon, the enclosed bed is reassuring. Meanwhile, the wide south window provides a large view on the outside. This connection is also a good way to emphasize the interior space.

Napevomo was conceived with regard to the major principles of bioclimatic architecture. During the winter, it captures, stores and conserves the heat, while during the summer, it protects from the sun and dissipates the heat. We translated these general principles into specific criteria as follows:

- Compactness: Napevomo has a shape factor near to one, thus with the minimum of exterior surfaces.
- Distribution of windows: In order to capture maximum sunlight in the winter, the windows are mainly located on the south side. Openings are minimized on the east and especially on the west sides, because the solar gains are very important on these fronts in the summer. On the north side, which receives no solar gain in winter, glass surface is minimized.
- Arrangement of spaces: the spaces are arranged according to the path of the sun. The living space is wide open on the south, while buffer areas (toilet, bathroom, mechanical room, kitchen) are located alongside the north facade (see figure 3).
- Sun protections: Napevomo features two type of solar protections: the first one is a sunshade overhang which protects the south facade (90 % all summer). Shutters complement sun protection on the south side, as well as for windows of the other facades (see figure 1).

Construction and Materials

The constructive system was conceived to be prefabricated and easily transportable, while ensuring high energy performance. Consequently, we chose elements in two dimensions, because they are easy to transport (with a minimum of trucks); when assembled, they form a perfectly tight, isolated envelope (see figure 2).

We wanted to optimize transportation in order to limit related CO₂ emissions and embodied energy of the

house. We looked for innovative assembly solution which would also improve transportation. Accordingly, we selected elements that can easily be put on lorries, and that minimize volume in order to limit the number of trucks needed.

For the structure of the walls, we opted for a skeleton structure. This technique allows the realization of a resistant structure with the use of little sections (120 mm x 45 mm), and is suitable for prefabrication. The floor and the roof are formed of boxes structured by glulam and filled with insulating material. A new process, namely green wood (not dried out) assembly, was used for the glulam beams. This new technique reduces the embodied energy of the final product and enhances mechanical properties, compared to conventional glulams (see figure 4).

The envelope of a house has to assure the thermal comfort of the inhabitants without any active heating or cooling system. For that purpose, the envelope must be well isolated, but also possess a sufficient thermal inertia to store the heat.

For the insulation of the envelope, we chose wood fiber for walls, and cellulose wadding for the floor and roof. They represent one of the best compromise between summer and winter performances, and have a low environmental impact. Moreover, raw soil was added on the inside of the walls in order to bring inertia. On the floor, 80 mm of raw clay and a terra cotta flooring allow the passive storage of heat.

For the windows, we chose triple glazing, considering its specific features and good negotiation of heat insulation (characterized by the heat exchange factor) vs solar radiation (characterized by the transmission factor).

The main constituent material of the house is wood. Specifically, we chose maritime pine from the Landes forest -the most cultivated in Europe-, which is located in the Aquitaine region (France). Timber is a renewable material (when produced in a sustainable fashion, so as for the Landes forest). It acts as a carbon storage, which makes it at least carbon neutral. Timber also has

interesting thermal properties. Compared to a steel structure or a solid wall, a timber structure reduces thermal bridging, thanks to its high thermal resistivity.

The east side of the house is covered with a vegetal wall. The roof is also a green roof. They are self-irrigated, create a micro-climate and tend to improve comfort during the summer.

Interior Comfort, HVAC and House Systems

The comfort inside the house is primarily ensured by the overall bioclimatic architectural conception and envelope performance of the house. It is assisted by the energetic systems, which enable reaching the temperature comfort criteria, while consuming as less energy as possible.

The air is cooled by an innovative passive system based on the use of phase change materials (PCM) within an air-PCM exchanger. Daytime energy can be stored via direct exchange between the air inside the building and the PCM; these are regenerated at night by the circulation of cool external air in the exchanger. This controllable system opens up a range of powerful air cooling possibilities -far beyond the performances of latent heat storage in the walls (envelope of the building or internal partitions) or solid objects containing PCM. Its storage capacity in terms of energy can easily be adjusted by adapting the exchanger(s) to the specific needs of the house. We installed four phase change material exchangers in the floor of our prototype, which was specifically designed for this purpose (see figure 5).

A HVAC system completes the systems described above, while ensuring overall operational safety for heating and air cooling functions. Our system consists of a heating module using a water-air exchanger. It provides energy from the solar DHW. Most of the heating is achieved by air ventilation: a double flux fan recovers heat from the used air to heat the air intake, followed by a micro-heat pump which backs-up the main heating system. Conversely, by transmitting its heat to the used air, the main heating system can cool incoming air in the

summer. It provides, for both winter and summer, a back-up in case there is not enough domestic hot water or regenerated phase change materials, respectively.

Lighting concepts and main objectives. We wanted to ensure an optimal visual comfort while consuming electricity as less as possible. We wanted the Napevomo house lighting design to satisfy the two following conditions:

- To privilege natural lighting during the day
- To minimize the energy consumption of artificial lighting

To favor natural lighting, we oriented and glazed spaces according to their function. In order to obtain an original, additional natural lighting, we designed a zenithal window. The house is also oriented south, and presents wide south glazing. This way, Napevomo is like a protective space opened to the nature, where the inhabitants benefit from a significant quantity of natural light.

For artificial lighting Napevomo uses LED technology. They have two advantages: they consume only 1-3 Watts, while common lights consume 50 to 60 Watts. Their lifetime can reach 100.000 hours (more than 50 years for an average use of four hours per day). LEDs are cheap, environment-friendly and totally safe for human health.

Concepts and main objectives for water use. We designed a complete water cycle reducing clean water consumption and grey water discharge in the environment. The self-irrigated green roof is a great opportunity to close the cycle, thanks to the integration of a water treatment based on earth worms. This natural process significantly reduces the size of conventional water treatment plants. Our water network was designed as follows:

A drinking water supply network [21] provides water to the entire house, i.e.: kitchen sink and dishwasher [20], shower and bathroom washbasin [19], washing machine [18], and toilets [6]. The wastewater from these appliances and fixtures passes through a screen rake [17] which removes large particles in suspension

(hair, organic waste, etc.). As the worm filter cannot be watered continuously, a 200-litre buffer tank (16) is used to store the water that has passed through the screen. Twice a day, grey wastewater is removed from this buffer tank using the 120W pump (15) and is spread over the worm filter surface (13) using a spray nozzle (14). This water passes through the different layers of the worm filter, and then through a second screen rake (12) who catches any earthworms or wood chips that may have escaped the previous worm filter. The water from the worm filter; is recyclable, it is stored in a 2 m3 buffer tank (9).

It is then re-used, via a secondary circuit, to water the vegetation on the roof and walls of the Napevomo house, and to supply the toilets. Watering the vegetation contributes, through evaporation of the water in all the substrates, to evapo-transpiration (1) from the green roof (2) and from the sun screen formed by the green wall, which cools the house during the summer. Consequently, the green roof has to be watered abundantly, several times a day. In order to do this, a 200-litre buffer tank (4) on the roof prevents eventual pressure losses associated with the watering of the vegetation.

Two pipes connect the buffer tank (4) to the storage tank (9): a filler pipe (using a pump 10) and a runoff pipe if necessary. Two pipes also connect the green roof to the buffer tank (4). One supplies water (using the irrigation module pump (3) for the green roof and the green eastern wall of the Napevomo). The other is connected to the gutter: it recovers that water that has not been captured by the green roof and sends it into the buffer tank (4) to be used again for irrigation or for the toilets. Two overflow pipes (6 and 8) and an overflow collector (11) complete the overall water network system (see figure 6).

Solar Systems

Energy production is via: 1) an innovative solar electricity domestic hot water (DHW) co-generation system, and 2) by using a 16 m2 surface area of traditional photovoltaic cells, produced by the SunPower company (10 modules SPR-315-WHT with a declared optimal yield of 19.3%).

The co-generation system consists of a cylindrical parabolic mirror which concentrates radiations (about 50 times) through a line of photovoltaic cells fixed to a solid metal support; 1D solar tracking is achieved by a controlled rolling movement of the mirror support (made of fibrous concrete), placed on the roof of the house. To ensure that the cells are kept at a temperature compatible with their optimum yield, controlled water circulation regulates the temperature of the support holding the cells. This cooling circuit produces domestic hot water which is stored in a tank; any surplus hot water is evacuated by an air heater. With this system, the use of the photovoltaic cell surface is limited, thus ensuring that using high yield cells is economically efficient (see figure 7).



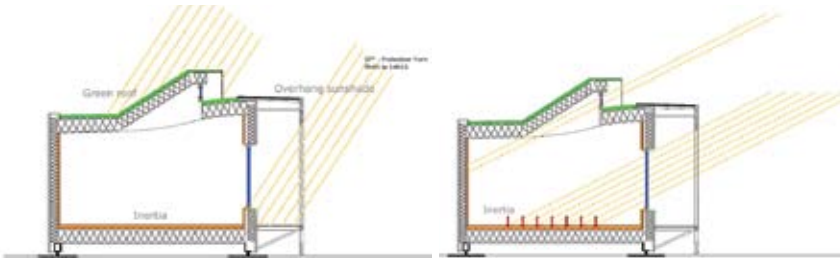
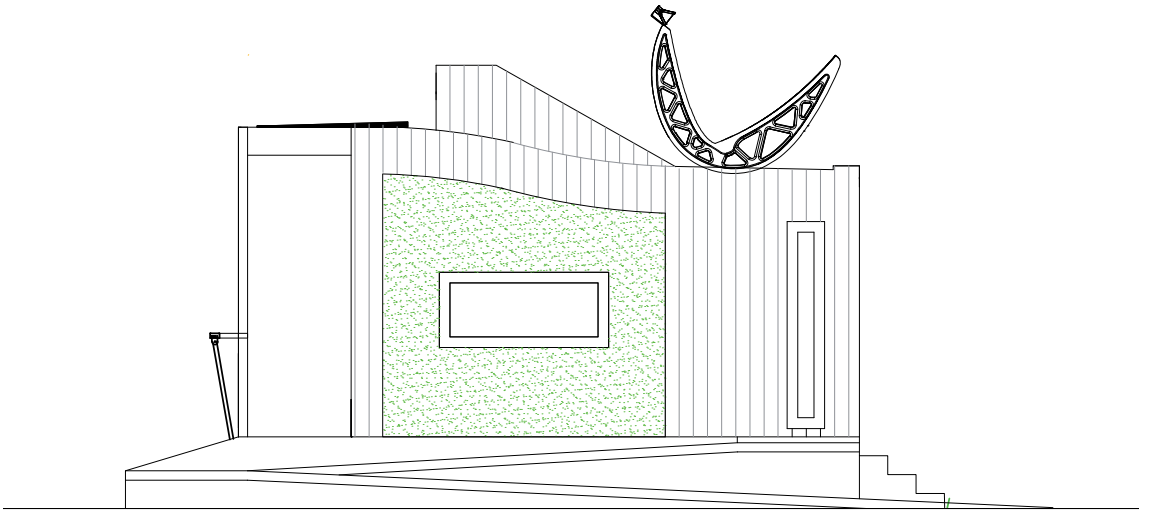
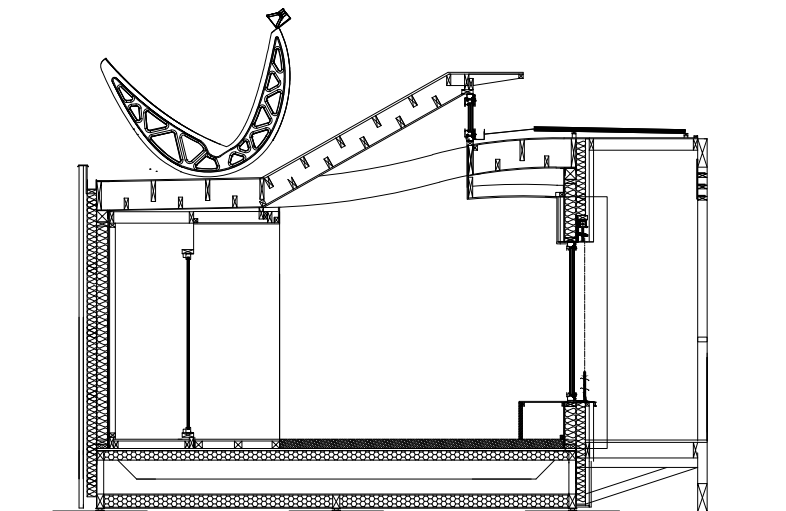

Figure 1: Principles of the bioclimatic architecture (a) summer strategy, (b) winter strategy.
 Figure 2: House envelope structure, exploded view of the main components.
 Figure 3: House envelope structure, global view of the timber structure.
 Figure 4: (a) plan of Napevomo, floor plan, (b) photograph.
 Figure 5 : Phase Change Material based air tempering system.
 Figure 6 :Phase Change Material based air tempering system. Detail of the closed ducts system.
 Figure 7 : (a) view of east facade of Napevomo: north and south positioning of energy production systems, respectively by co-generation and using "traditional" photovoltaic cells (on the south-facing canopy). (b) concentration co-generation system and solar tracking.



East site elevation



Transversal section

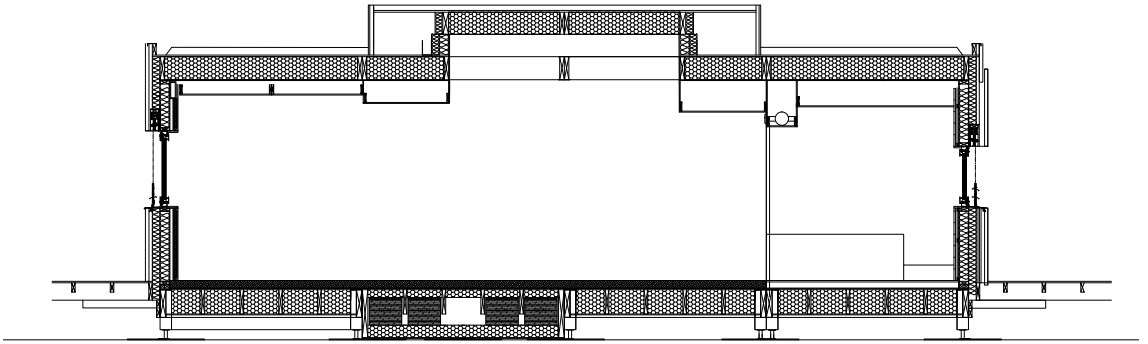

Longitudinal section

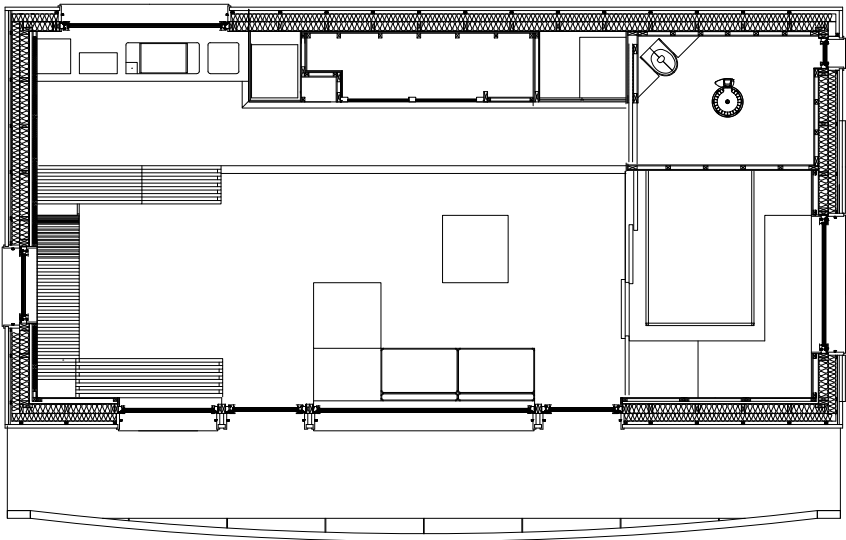

Floor plan

TECHNICAL DATA OF THE HOUSE

Project name:

Napevomo

Construction area:

74 m²

Conditioned area:

46 m²

Conditioned Volume:

125 m³

ENERGY BALANCE

Estimated energy balance:

Consumption (In Bordeaux):

2.670 kWh

Production (In Bordeaux):

4.500 kWh

Consumption (In Madrid):

2.850 kWh

Production (In Madrid):

6.000 kWh

Energy balance (In Bordeaux, France):

+ 1.930kWh/a

Energy balance (In Madrid, Spain):

+ 3.150kWh/a

Estimated CO₂ Emissions:

In Bordeaux with French coefficient (0.09 kgCO₂/kWh):

0,240 Tn/a

In Bordeaux with European coefficient (0.4 kgCO₂/kWh):

1,1 Tn/a

In Madrid with French coefficient (0.09 kgCO₂/kWh):

0,256 Tn/a

In Madrid with European coefficient (0.4 kgCO₂/kWh):

1,14 Tn/a

Estimated energy production:

Production (In Bordeaux, France):

4.500 kWh

Production (In Madrid, Spain):

6.000 kWh

Photovoltaic system:

Total installed PV power (kW):

Sunpower Monocrystallin Panels:

3,15 kW

Parabolic Through Concentrator:

2 kW

Types of PV Modules:

Monocrystallin

ENERGY CONSUMPTION

Estimated energy consumption:

Total consumption of the house (In Bordeaux, France):

2.670 kWh/a

Total consumption of the house (In Madrid, Spain):

2.850 kWh/a

Estimated electrical consumption:

Consumption in Bordeaux, France:

54 kWh/m²a

Consumption in Madrid, Spain:

57 kWh/m²a

Characterization of energy use:

Bordeaux		
	Consumption (kWh)	%
DHW	577	22
Appliances	1213	45
Auxiliaries	733	27
Lighting	38	1
Cooling	11	0,4
Heating	95	4
Total (kWh)	2667	

Madrid		
	Consumption (kWh)	%
DHW	577	20
Appliances	1213	43
Auxiliaries	733	26
Lighting	38	1
Cooling	235	8,2
Heating	55	2
Total (kWh)	2851	

CONSTRUCTION ENVELOPE

Insulation types (type and thickness):

	Material designation	Thickness[mm]	ρ [kg/m ³]	λ [W(m.K)]	C_p [J/(kg.K)]	μ
1	Wood cladding	500	0,14	2400	35	-
2	Ventilated air sight	44	-	-	-	1
3	Wood fibre	100	170	0,042	2100	5
4	Wood fibre	120	55	0,038	2100	5
5	Wood frame 45 /120	120	500	0,14	2400	35
6	Bracing, vapor regulator	8	800	0,1	2100	60
7	Technical space	40	500	0,14	2400	35
8	Gypse	12,5	1125	0,36	1265	11
9	Raw clay	40	1950	0,87	850	8
10	Gypse	12,5	1125	0,36	1265	11

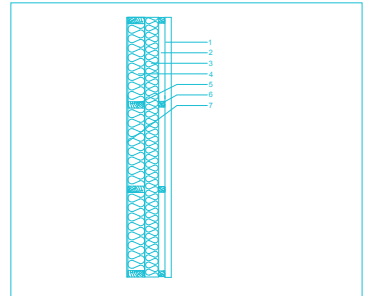

	Material designation	Thickness[mm]	ρ [kg/m ³]	λ [W(m.K)]	C_p [J/(kg.K)]	μ
1	Laminated wood 360x75	360	500	0,14	2400	35
2	Laminated wood 315x48t	315	500	0,14	2400	35
3	Plywood	10	580	0,13	1500	75
4	Cellulose wadding	315	70	0,041	2000	2
5	Vapor regulator		160g/m ²			Sd= 110m
6	Plywood	22	580	0,13	150	75
7	Raw clay	70	1950	0,87	850	8
8	Terra cotta	20	1900	1,15	900	10

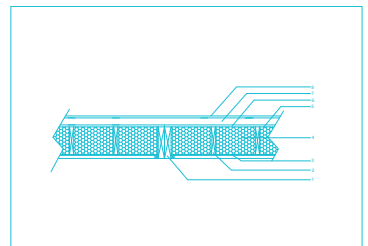

	Material designation	Thickness[mm]	ρ [kg/m ³]	λ [W(m.K)]	C_p [J/(kg.K)]	μ
1	Green roof	50	1700	1,26	600	-
2	Drain	20	-	-	-	-
3	Roots protection	10	-	-	-	-
4	Waterproof membrane	2	-	-	-	-
5	Plywood	22	580	0,13	1500	75
6	Solid wood 220x45mm	200	500	0,14	2400	35
7	Wormcell	300	32	0,041	2000	2
8	Solid wood 120x45mm	100	500	0,14	2400	35
9	Vapor regulator		160g/m ²			Sd= 110m
10	Plywood	8	800	0,1	2100	60
11	Technical space	25				
12	Gypse	12,5	1125	0,32	1623	13

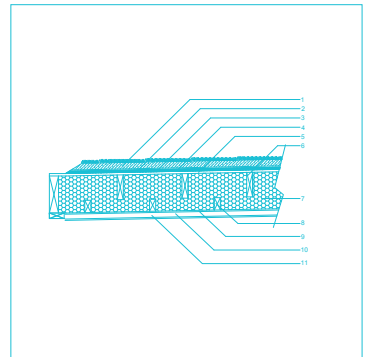

Constructive Systems thermal transmittance:

	Thermal transmittance [W/m ²]	Heat storage capacity [Wh m ² k]	Heat displacement (h)
Walls	0.17	31	14.8
Floor	0.12	45	15
Ceiling	.12	8	14

COSTS

Construction Cost:

350.000 € (for the 50m² house)

Industrialized Estimate Cost:

2.000 €/m² (for a 100m² house)

Information provided by the university

RE:FOCUS

University of Florida, United States of America

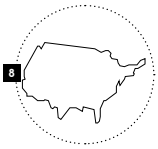

Nº.8 / 743,22 points

Contest 1: Architecture: 72,00 points.

Contest 2: Engineering and Construction: 47,00 points.

Contest 3: Solar Systems and Hot Water: 59,79 points.

Contest 4: Electrical Energy Balance: 118,32 points.

Contest 5: Comfort Conditions: 90,87 points.

Contest 6: Appliances and Functioning: 106,54 points.

Contest 7: Communication and Social Awareness: 72,00 points.

Contest 8: Industrialization and Market Viability: 51,00 points.

Contest 9: Innovation: 35,70 points.

Contest 10: Sustainability: 90,00 points.

Bonus Points and Penalties: 0,00 points

Introduction and Main Objectives of the Project

Project RE:FOCUS addresses sustainability by advancing knowledge on industrialized solar-powered houses with high life-cycle energy and material efficiency. Within the context of the 2010 Solar Decathlon Europe, industrialization was the basis for investigating new design and construction processes that challenge traditional approaches and exploit opportunities offered by industrialization and economies of scale to address affordability in sustainable housing.

The house fulfills these objectives through environmentally sustainable use of local materials, versatility in design, ease of construction due to its modular assembly, and its industrialized, highly energy-efficient shell. Specific objectives addressed were the role of technology in the house, the industrialization expressed in the construction and adaptability of the design to local materials and climate, and incorporating lessons learned from Florida vernacular house types.

The house integrates elements derived from Florida building traditions with modular, customizable construction suitable for industrialized production methods. Three primary architectural elements are consistent with Florida vernacular architecture: a covered open porch, a breezeway oriented to the prevailing wind, and a permeable building skin. A modular steel frame with six identical 1.8 m x 4.8 m bays provides structure for a 10.8 m long rectangular volume comprising two prefabricated modules separated by a breezeway. Modules and breezeway are shaded by

14.6 kW of photovoltaic above the roof and cylindrical solar collectors integrated into the south facade. These generate a positive energy balance, with the energy above use returned to the grid or stored in a battery.

Industrialization and flexibility are reflected in the "kit-of-parts" building approach that limits the shipped elements to the core elements and uses local building materials. This approach also accommodates modifications for regional climate, culture, and skill. The openings and glazing can also be designed to alter the energy performance of the home and adapt to the local climate. The modules establish a standard unit with steel frame connections that allow the addition of modules, either vertically or horizontally, for growing families or other needs.

Architectural Design

North Florida has bioclimatically adapted dwellings from the 19th century colloquially known as "Cracker houses" and defined by a central breezeway, a porch, and porous skin. These elements provide access, divide the social and private areas of the house, light and open the spaces of the house to the surroundings, and offer shelter from the intense sun while maximizing natural ventilation that is essential in this hot and humid climate. They offer great potential when combined with and expressed in an industrialized context.

Exterior design. The outermost layer of the RE:FOCUS house is an operable screen system that evokes the loose fitting, lightly constructed wood slat walls of the Cracker

house and selectively and adaptively protects the house from a variety of climate conditions. The screen shades the walls and openings and provides privacy to the breezeway while maintaining natural ventilation.

The modules' walls, floors, and ceiling are structural insulated panels (SIPs). Highly insulated folding window-doors provide complete access and light to the interior. The PV roof array passively shades the breezeway and reduces the load on the heating, ventilating, and air conditioning (HVAC) system of the house.

Interior design. The social living, dining, work, and food preparation spaces in a three-bay module are joined by the breezeway to the two-bay private bedroom and bathroom module. Window-doors placed in each unit facing the breezeway integrate the private and social areas into one comprehensive volume. Spatial flow is supported by the open and uncluttered character of the private and public spaces, and by the multiple glazed openings onto the deck.

Both modules have multipurpose casework and ceiling elements that define the functional zones. Overhead elements support the hierarchy of space with lower ceilings above the dining, kitchen, and workspace areas, and a higher ceiling in the living space. Casework integrates lighting, acoustical panels, appliances, air conditioning equipment, and storage. The southern edge of the house is a functional strip through which services are distributed and accessed by the kitchen, technology hub, bathroom, and mechanical room spaces.

Architectural elements or design decisions that contribute to the interior comfort and saving energy.

The Florida Cracker house-derived passive strategies of breezeway, loose skin, and porches save energy and foster interior comfort. The house's compact 10.8 m x 4.8 m volume is cardinally oriented with the largest window exposure on the north; east and west fenestration is limited. Highly insulated structural panels; glazing elements; fixed and operable shading elements including cylindrical solar panels on the south facade; and solar canopy on the roof provide passive comfort and energy savings.

Construction and Materials

Construction and industrialization systems. The UOF Team's goal was to construct the house in a safe, efficient manner while using proper construction techniques. The RE:FOCUS house is designed for efficient construction through pre-fabrication. The panelized, modular system

addresses the need to assemble, move, and disassemble the house efficiently and repeatedly. Elements that normally require significant time to install, such as interior floors, are pre-assembled into standardized panels for quick and easy installation. The house can be flat-packed and shipped in standard sea containers; assembled and pre-finished modules can be shipped by truck. Modules are connected on site and the deck and external finishes complete the house

The structural steel system for the foundation, vertical wall, and roof also support the solar canopy and can support other customized elements. The structural system has fourteen support points, which limits the impact to the site. The structural insulated panels are produced in a controlled environment, allowing for dimensional control, efficiency, and limited waste during construction. Sustainably sourced wood materials include salvaged interior flooring, screens made from acetylated pine—a process that turns fast-growing wood harder and as long lasting as a tropical hardwood—and reclaimed Florida cypress.

House Envelope. The layered envelope reduces energy consumption, maximizes functionality, and enhances sustainability and industrialization. The envelope components are a slatted wood screen supported by the steel frame, a rain screen, and the SIPs. These elements combine to produce an industrially produced envelope with solid thermal performance. Fenestration includes three sets of low emissivity, insulated glass window-doors on the north facade and aluminum windows in the east and west facades with integrated exterior louvers with hurricane wind rating for shading and daylight redirection.

Interior Comfort, HVAC and House Systems

Interior comfort. The heating and cooling system is zoned for optimal indoor conditions and enhanced energy efficiency. The house has a multi-terminal mini-split HVAC system which allows for independent temperature control of the living and sleeping zones of house, reducing heating and cooling energy use. A control system for lighting and indoor temperature also provides feedback on energy usage. The occupant is able to manually control passive and active comfort conditions through the manipulation of shading devices and openings.

Natural and artificial lighting. Three window-doors admit an abundance of daylight without increasing the heat absorbed by the house. Adjustable exterior shading

devices provide maximum user control for privacy and lighting. High-performance luminaires with LED lamps provide task-appropriate illumination with an expected lamp life of 50,000 hours and minimal heat production at the luminaire. A low voltage DC system integrated in the control system has three lighting profiles and efficiency settings in order to optimize different lighting scenarios. Additionally, all the major spaces are equipped with occupancy sensors that turn off lights when the space is not in use and with daylight sensors that connect to dimmer controls for reduced energy use.

Water use. In order to conserve water, 20% more efficient appliances, faucets, showerheads and toilets and a grey water system are used. The grey water from the shower, lavatory, and clothes washer, which typically comprises 50-80% of waste water, is filtered in a grey water system and used for irrigation. The system can potentially be used for rainwater harvesting, and water reused for toilet flushing.

Non solar hot water system. An efficient air-to-water heat pump generates hot water and provides cooling to the bedroom module when needed. The heat pump heater and highly insulated electric water tank extract heat from the ambient air and store it in the water tank. South-facing glazed doors in the mechanical room increase its solar gain and thus ambient temperature; this, combined with heat generated by the equipment in the room, improves the efficiency of the heat pump water heater.

Solar Systems

PV system. The solar electric systems include the roof-mounted solar canopy and the vertically-mounted south facade array. Fifty-four solar panels in a 3 x 18 array cover the roof of the house; each panel is rated at 230 W for a total of 12.4 kW. More square footage of the house is covered by solar panels (80 m²) than is conditioned (60 m²).

The vertically mounted, cylindrical, thin film copper/indium/gallium/selenium PVs on the south facade is an experimental, innovative application of a product otherwise designed for horizontal installation. The array collects sunlight from all angles, including light that passes through the cylinders and is reflected from the cladding. The array consists of twelve 182 W solar panels for a total of 2.2 kW and the total installed PV is 14.6 kW. Two 6,000 W inverters for the roof array and one 3,000 W inverter for the vertical panels convert direct to alternating current.

Singular Systems

As a buildings' operational energy is reduced, the embodied energy of the materials and systems used to construct the house become more important in the overall energy use profile. A simplified calculation of the embodied energy of the major building materials and systems was conducted in order to determine the energy invested in the construction of the house. This embodied energy was then compared to the energy produced by the photovoltaic (PV) systems integrated into the house to develop an "energy payback" profile.

The primary systems examined include the PV, steel structure, and structural insulated panel (SIP) skin. The embodied energy of the PV panels is 45,480 kWh; that of the steel structure is 6,830 kWh. The embodied energy of structural insulated panels, polyurethane foam core (23,500 kWh) and oriented strand board (OSB) faces (8,900 kWh) is 32,400 kWh. The total embodied energy of the house represented by the steel structure, the SIP panels, and the PV system is 84,684 kWh or 1,170 kWh/m². The annual energy produced by the PV system is 13,000 kWh above the house's consumption, yielding an energy recovery period of 6.5 years. The avoided CO₂ emissions compared to average electricity generated from primary energy sources within Florida (coal, natural gas, and petroleum) is 1,500 tons CO₂ per year.



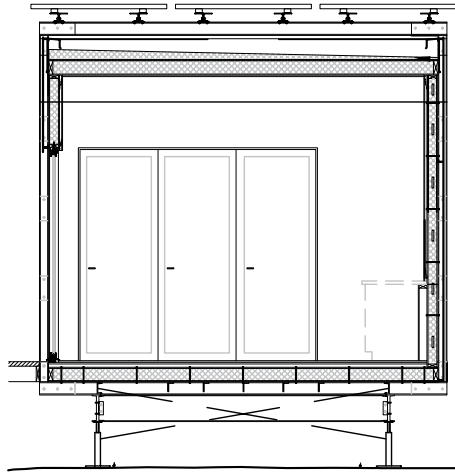

Living module section



North elevation with screens (open position)

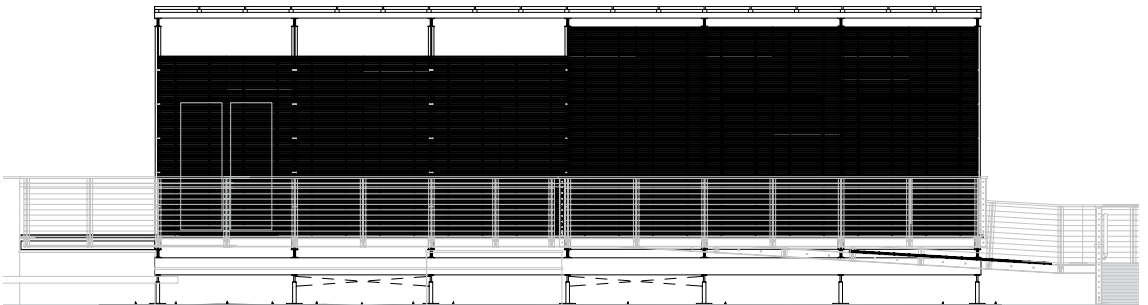

North elevation with screens (down position)

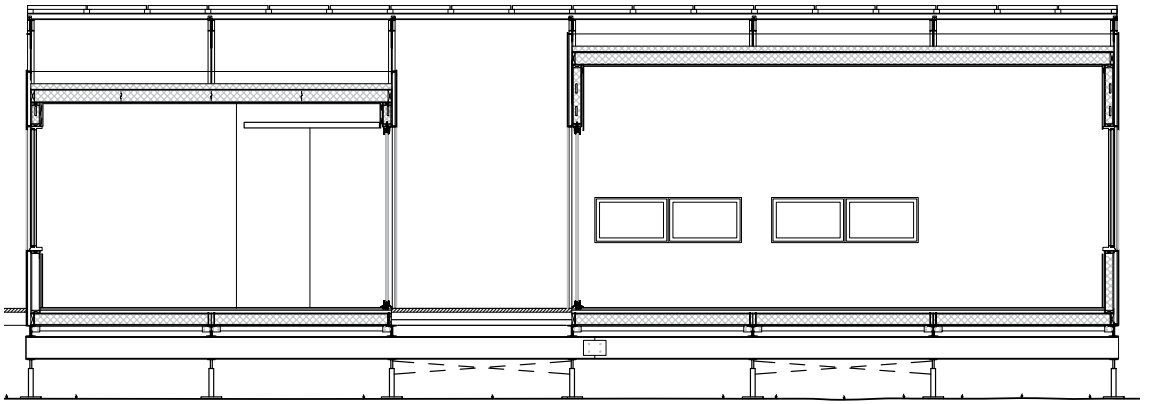

Longitudinal section looking south

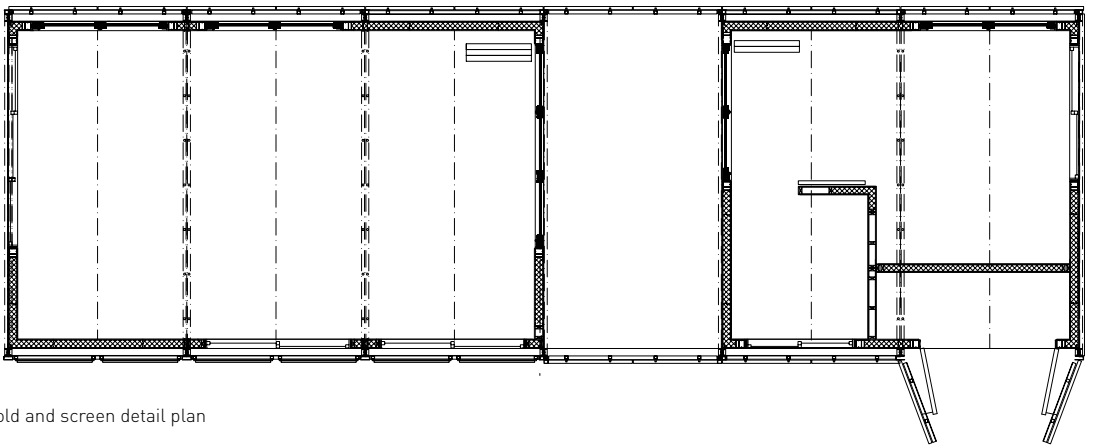

Bifold and screen detail plan

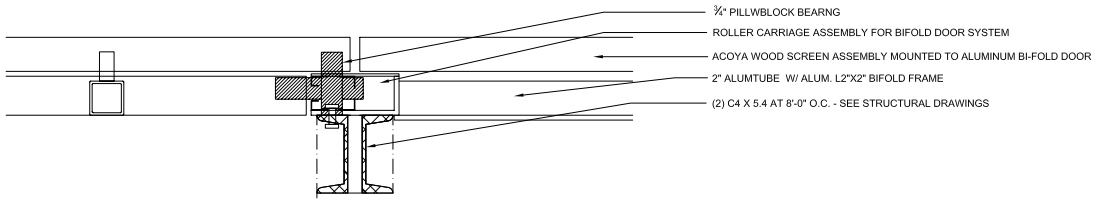

Bifold detail pillow block bearing

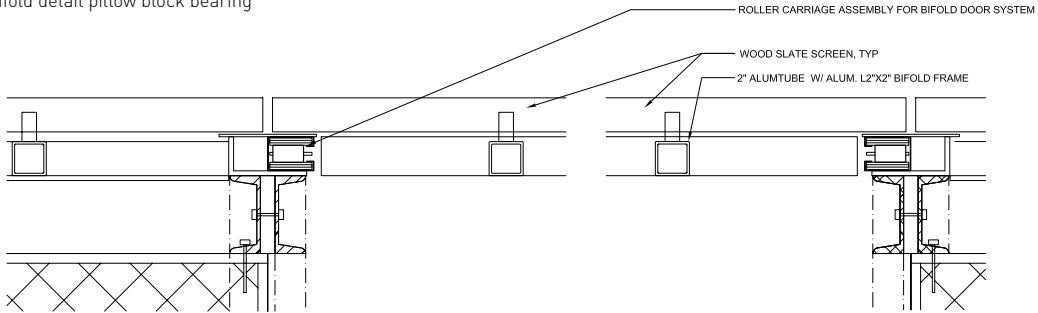

Bifold detail rail and trolley

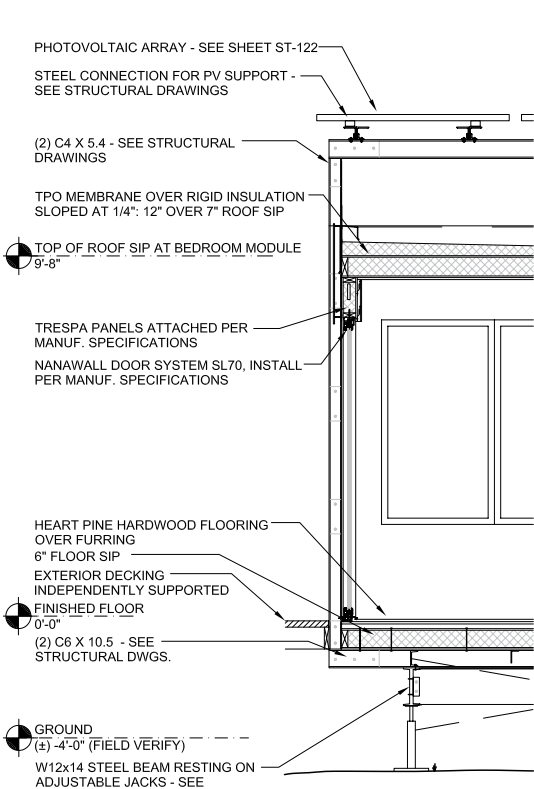

Wall section

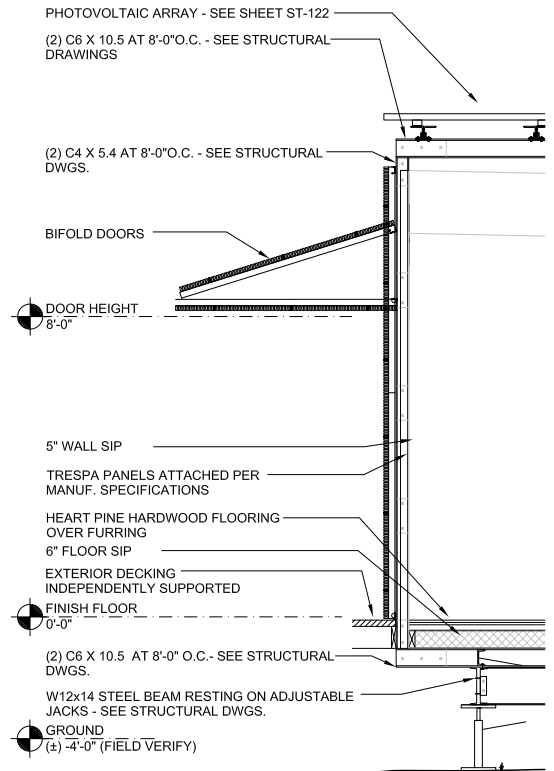

Wall section

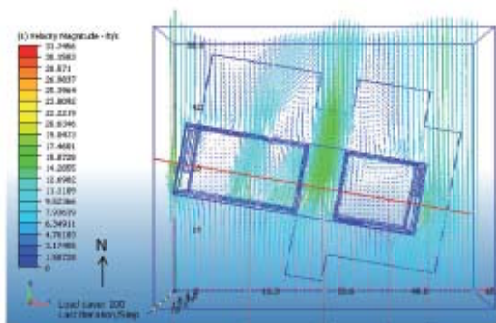

Figure 1: Air velocity through horizontal cut plane - This vector diagram illustrates air currents throughout the house. Velocity peaks through the breezeway and edges of the structure. With high temperatures, the relatively high interior air velocity can improve thermal comfort.

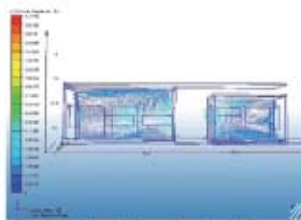
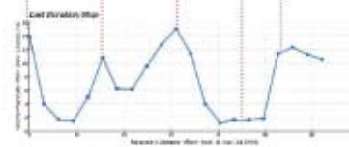

Figure 2: Interior velocity vectors - Air velocity peaks around the vicinity of the south-facing windows. Swirling velocity vectors indicate air currents moving vertically in the space.

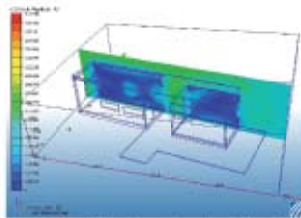

Figure 3: Air velocity along east-west cut plane - The green regions indicate faster moving air around the building envelope, and thus reducing energy loads. The lighter blue regions indicate higher velocities near the openings to the breezeway.

Ventilation Study Scenario 1

Conditions: 5mph wind from south
House configuration: all doors and windows open

This scenario illustrates the effects of moderate winds on comfort level. The placement of fenestration creates interior currents that circulate through the space. In a hot, dry climate, air speeds greater than 1 ft/s can significantly improve comfort levels. This simulation illustrates that the interior receives at least 1 ft/s throughout the space (Figure 3).

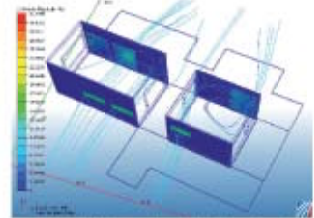

Figure 4: Particle trace - air entering the west module circulates through the living space before exiting through the north. Wind entering the south-facing window of the east module circulates through the sleeping space.

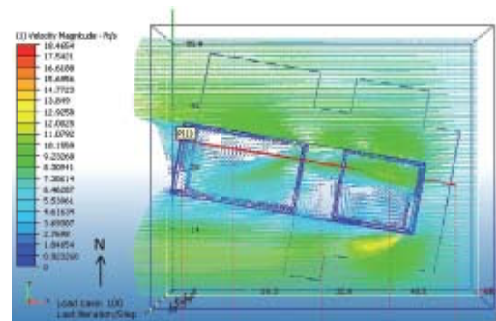

Figure 1: Air velocity through horizontal cut plane - This vector diagram illustrates air passing directly through the smaller volume of the east module. After passing through the breezeway, the flow expands in the west module and exits through the fenestration on the south and west facades.

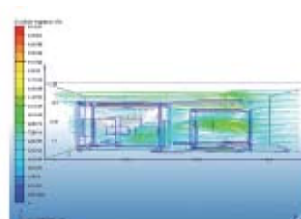

Figure 2: Interior velocity vectors - Air passing over the east module deflects the main airstream downward through the breezeway and into the main living space.

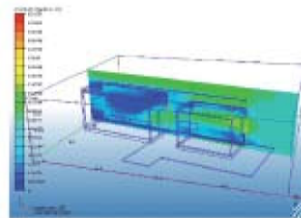

Figure 3: Air velocity along east-west cut plane - blue regions in the center of the west module indicate a diversion of flow around the perimeter of the space.

Ventilation Study Scenario 2

Conditions: 5mph wind from east
House configuration: all doors and windows open

This scenario illustrates how a moderate eastern wind will pass freely through the eastern module at rates possibly above desired. Adjusting fenestration would be necessary help regulate flow directly normal to the openings.

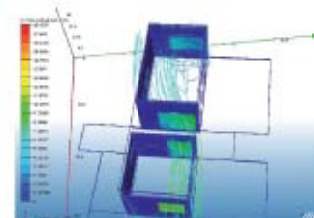
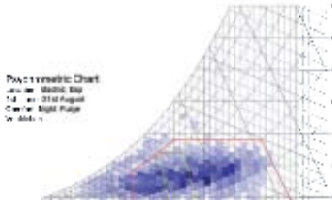
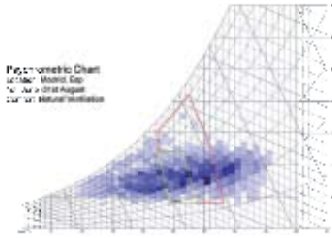
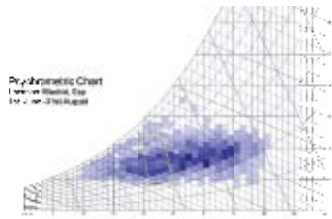
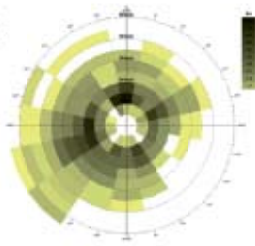

Figure 4: Particle trace - Air passing through the east module pulls air moving around the perimeter of the structure into the main living space where it circulates.



Prevailing Winds
 Average Relative Humidity
 Location: Madrid, Esp
 Date: 20th August



Prevailing Winds
 Average Relative Humidity
 Location: Madrid, Esp
 Date: 20th August

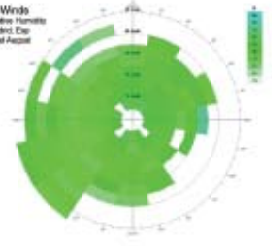

Criteria in Orientation
 Base: 0.5
 1. North - based on average daily
 2. Windy - values on a central surface
 Location: Madrid, Esp
 Current: 21st August
 Coordinates: 40.4167

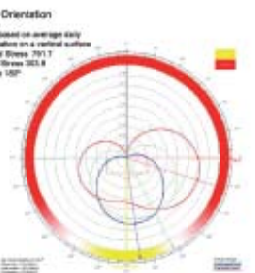

Prevailing Winds
 Average Relative Humidity
 Location: Madrid, Esp
 Date: 20th - 21st August

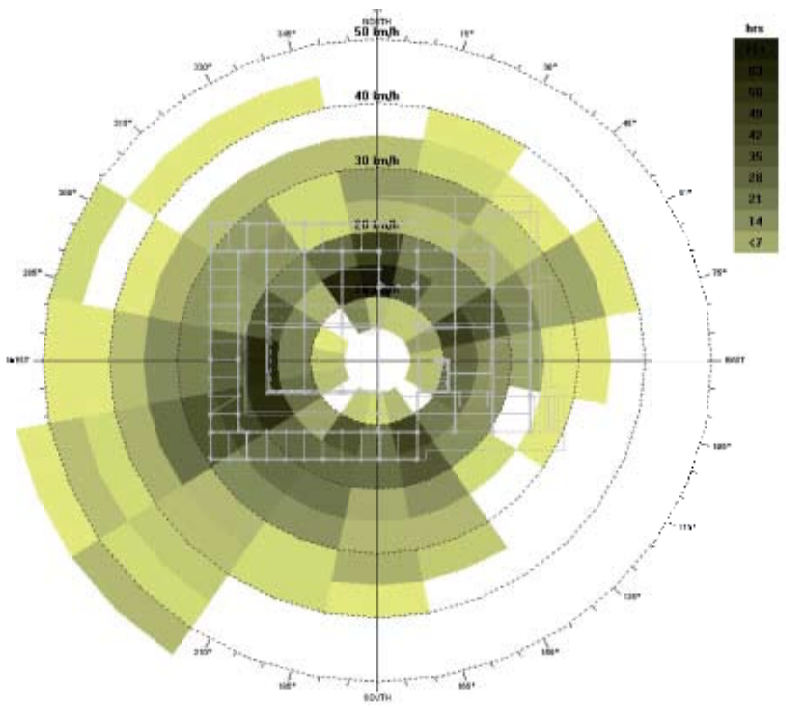
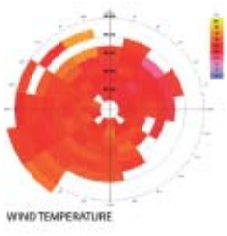
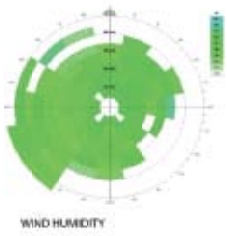
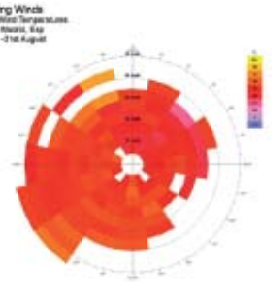

Environmental conditions analysis

TECHNICAL DATA OF THE HOUSE

Project name:

RE:FOCUS

Construction area:

70 m²

Conditioned area:

46 m²

Conditioned Volume:

150 m³

ENERGY BALANCE

Estimated energy balance:

12.500 kWh/a

Estimated CO₂ emissions:

4.000 kgCO₂ /a

Estimated energy production:

18.000 kWh/a

Photovoltaic system:

Installed PV power (kW):

14,6 kW

Types of PV Modules:

SunPower 230

Solyndra 182

ENERGY CONSUMPTION

Estimated energy consumption:

6.200 kWh/a

Estimated electrical consumption:

135 kWh/m²a

Characterization of energy use:

Annual production and Consumption: Cooling 9%, Heating 64%, Fan 8%, Appliances 19%, Lights 1%

CONSTRUCTION ENVELOPE

Insulation types:

Polyurethane foam, 8,9 cm walls; 14 cm floors and roof.

Constructive Systems thermal transmittance:

Walls 0,26 W/m²K

Floors 0,17 W/m²K

Roofs 0,17 W/m²K

Information provided by the university

SPECIAL AND INNOVATIVE SYSTEMS

Kit-of-parts assembly of modular, panelized components; bioclimatic strategies derived from traditional North Florida construction; multilayered envelope with structural insulated panels (SIPs), high-insulation window-doors and operable screen system; photovoltaic system including rooftop solar canopy array and façade-mounted cylindrical solar collectors; air-to-water heat pump; grey water recapture system; 1.500 tons of CO₂ emissions avoided per year as compared to an average Florida house consumption.

COSTS

Construction Cost:

313.000 € including donated materials

Industrialized Estimate Cost:

140.000 €

SML House

Universidad CEU Cardenal Herrera, Valencia, Spain



Nº.9 / 736,55 points

Contest 1: Architecture: 96,00 points.
Contest 2: Engineering and Construction: 62,00 points.
Contest 3: Solar Systems and Hot Water: 60,44 points.
Contest 4: Electrical Energy Balance: 112,91 points.
Contest 5: Comfort Conditions: 68,90 points.
Contest 6: Appliances and Functioning: 98,91 points.
Contest 7: Communication and Social Awareness: 29,30 points.
Contest 8: Industrialization and Market Viability: 67,30 points.
Contest 9: Innovation: 45,80 points.
Contest 10: Sustainability: 90,00 points.
Bonus Points and Penalties: 5,00 points.

Introduction and Main Objectives of the Project

As academics, our participation to the Solar Decathlon Europe was motivated by the integration of knowledge and the collaborative nature of the work the applied research program of the organization proposes. So inspired, the *Escuela Superior de Enseñanzas Técnicas de la Universidad CEU Cardenal Herrera* jumped into the competition. It was a unique occasion for students to actively participate into the design and actual building of a housing prototype featuring modularity, prefabrication, and energy efficiency – among other things.

Architectural Design

Our design is meticulously thought, yet at the same time flexible in its composition. We carefully analyzed possibilities offered by prefabricated modules, so they can be arranged according to the preferences of the client. That's why we named our prototype "SML", which stands for the letters used for the size of clothes (small, medium and large).

Each prefabricated module integrates, in a "single piece", three functions whose relative position can be adapted or re-worked: a living area, a storage (or integrated furniture) and an outdoor-connected courtyard. The courtyard contributes to the general quality of the space, as well as it enhances intimacy in or in between indoor areas. It also enables a better control of ventilation and sun exposure. Each module represents a "minimal living space" easily transportable once assembled. It has a size of 1.85 m x 7.80 m, and offers four alternative

arrangements or configurations for the courtyard (within the storage widths). Storage is inserted in the facade's thickness, and therefore contributes to the insulation of the house.

The use of integrated PV – a relatively modern material – allowed us to integrate the PV panels and the exterior finishing. Corian® offers the advantage of easy handling: PV panels harmoniously adapt to the facade materials. We opted for a hybrid envelope which combines thermal collection and PV systems on one single technological plane, a feature that allows a perfect integration of both systems at all times.

The composition of the house is modular. Clients can specify how many modules they wish, and choose among a variety of configurations according to their specific uses or needs (familial housing, secondary residence, workplace, etc.). In the context of the Solar Decathlon Europe, a maximum scale of 74m² was set. Accordingly, our prototype explored exhaustively the configurations and possibilities for a house made out of six prefabricated modules.

The six modules have been organized around two longitudinal axes, banking on the minimalism and flexible positioning of the two courtyards. The courtyards serve two purposes: they enhance the bioclimatic performance of the house, and they organize interior spaces in delimitating the three basic functions/areas of the house. The living/dining room, the kitchen, and the bedroom/office are situated along the courtyard axes, enabling cross-ventilation and providing access

to indirect, natural light. Courtyards also connect to the facade. They provide access to the inside/outside of the house, while breaking its volume in two parts (and therefore making it less massive). From the outside, this is signaled by the use of differentiated colors: PV panels appear on the south facade, while they are missing on the north one. Black and white demarcate the two sides of the house, which are linked by one of the courtyards (i.e. which both differentiate and connect them). Consequently, each module has a unique structure. The design is as light-weighted as possible, and matches the constructive concept of the modules.

Construction and Materials

As we just noted, each module has a unique, specific structure. The orientation of beams and pillars offers a simple solution for the separation of the modules by inserting an elastomeric and waterproof band between the flat surfaces of the beams. The grounding of the house uses three bearing points for each module (out of a possibility of six). Each grounding is formed by a sub-structure of four light steel adjustable columns fixed onto a steel plate (which uniformly distributes the loads).

Interior Comfort, HVAC and House System

Electricity and plumbing. With respect to the modular conception of the house, connections have been unified. That way, the house can be extended without modifying previously installed systems.

Air conditioning. Air conditioning is one of our strengths. We opted for solar cooling systems (absorption chillers) and radiant cooling systems. The combination of both significantly reduces energy consumption.

Lighting. Because of its high efficiency, we chose LED technology for lighting.

Home automation. We favored the use of wireless technologies, in order to get rid of physical wires that would hardly fit the modular conception of the house. We combined wireless and standard KNX wiring,

which we connected through an Ethernet-based home automation system. This way, the entire house can be controlled from a computer, or from a home automation control panel. Remote access requires a Flash software accessible from the website.

Ventilation. The architecture enables cross-ventilation, relying on differential temperatures in the courtyards. When climate conditions do not allow natural ventilation, an alternative system provides forced ventilation. In order to prevent thermal losses in such a case, an enthalpic exchanger recovers heat rejections.

Solar Systems

One of the objectives of our prototype was to transfer, as much as possible, the house's consumption demands to the thermal field. To this end, we used solar capture technology of ultra high vacuum SRB collectors, which are especially suitable for these purposes. Their main shortcoming though, is that they compete for the surface with photovoltaic energy and photothermal energy, both of which solicit solar radiation. Moreover, the weight of the PV system is higher and it is less efficient. To solve these problems, we introduced a hybrid capture system called *EnergyBlock*. Three variants of this system have been integrated to the rooftop:

- SHS-EnergyBlock: hybrid PV and photothermal blocks that regulate the collection of the roof.
- T-EnergyBlock: purely thermal blocks with solar concentrating mirrors.
- PV-EnergyBlock: purely PV blocks.

PV Energy

PV collection on the facade. For this system, a-Si (amorphous silicon) thin film modules have been used. This is the most adequate choice for our ventilated facade from the point of view of energy and integration. A new material, Corian®, was useful to integrate the modules.

PV fixed on the roof. We have included PV-energyBlocks and a third of the SHS-EnergyBlocks with monocrystalline silicon modules. Since they have been installed on the

roof, they are exposed to a better incidence; for that reason, monocrystalline silicon has been chosen as the best energy solution.

Hybrid roof. This element regulates solar collection and is made of SHS-EnergyBlocks. The energy demand of the house can be calculated with the home automation system; our solution provides the possibility of alternative usages of either photovoltaic or photothermal collection.

Solar thermal. From the thermal point of view, the annual energy demand of our prototype is as reduced as possible. During the winter, the area of the thermal roof can be maximized. Solar collectors get the most out of radiation, even when diffuse. Such a maximized roof meets perfectly the thermal requirements of the absorption system. Besides, when air conditioning is not necessary, the roof can be used as a PV system.

Sanitary Hot Water (SHW). A thermal tank installed on the rooftop provides sanitary hot water (SHW). It covers over 60%, and therefore meets the SHW needs of the house. The whole SHW system is insulated and can be controlled through the home automation system, preventing unnecessary water losses (while waiting for the water to turn hot).

Air conditioning. The absorption system we chose is very demanding. The temperature supplied by the collector field needs to be very high. With the help of ultra high vacuum collectors, such high temperatures can effectively be managed. Collectors have been designed as medium temperature solar thermal systems; for that reason their stagnation temperatures are of 300 °C.

One of our challenges was to import these technologic systems from the industrial sector, and adapt it to housing. One of the issues at stake is to develop new applications that would better adapt to conventional systems.

Singular Systems

Two new systems have been designed so to improve the energy balance of the house.

The first one is an oven. It relies on medium temperature thermal collectors, which make better use of solar energy as a heat source -the latter being transferred to the oven through insulated hydraulic circuits. We also intended to minimize electricity loads. Aided by the industrial features of the solar thermal collectors, we imagined an oven fed by a solar thermal system. This system is independent from the previous one, and is more demanding in terms of temperature range. To manage a range of temperatures of 240 °C, the heat carrier fluid needs to be replaced; edible oil is used as thermal oil.

The second system consists of modules called E-Blocks, which can be configured in real time in order to capture solar thermal energy or electricity according to the needs. In addition, a control system determines ideal configurations at different moments of the day, considering both actual and projected consumption, solar radiation and energy priorities.



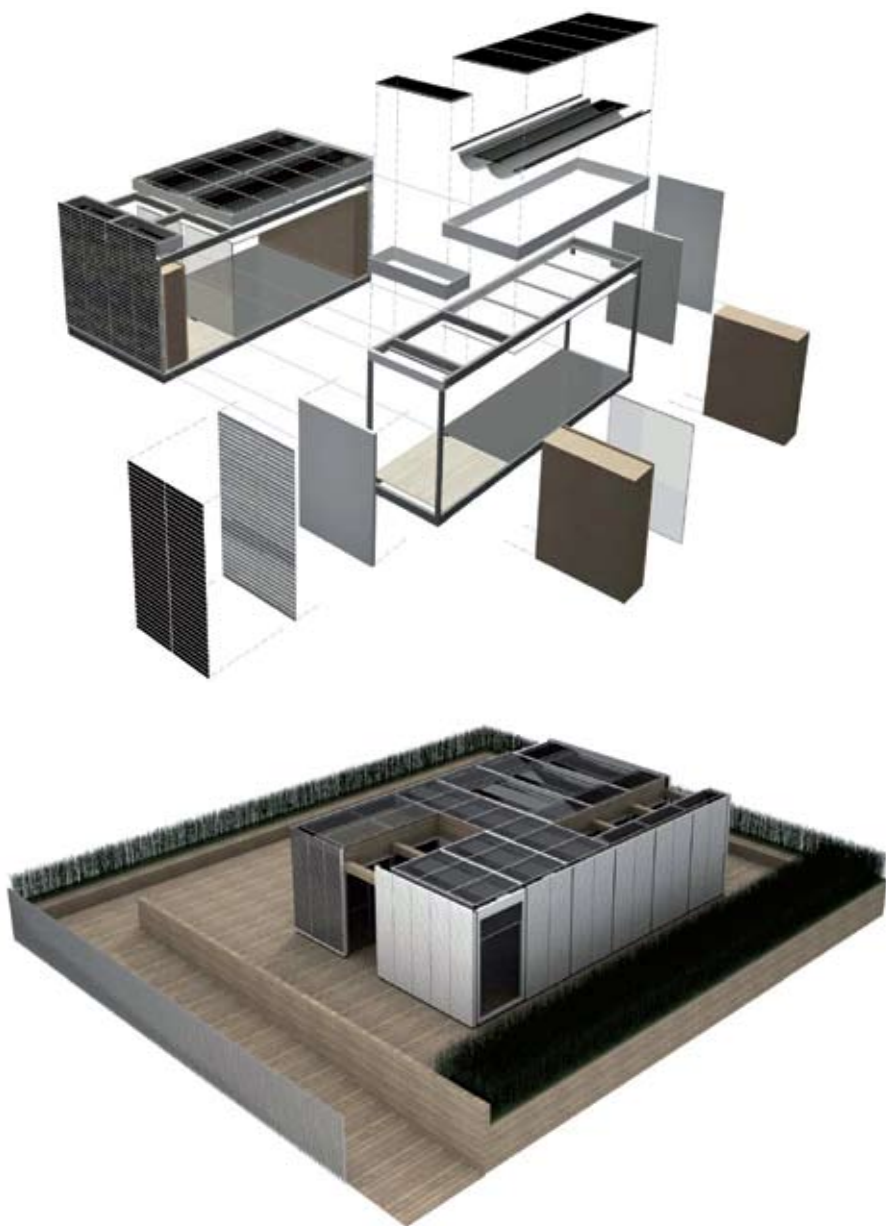

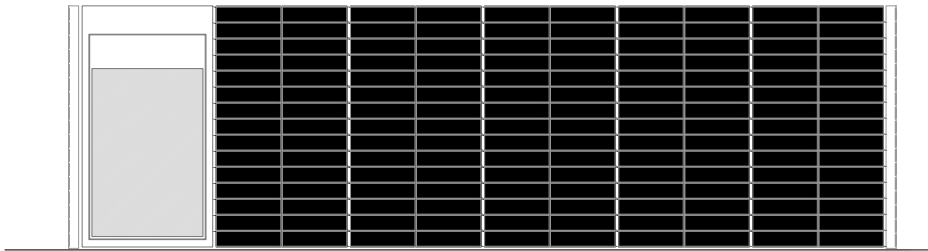

South elevation

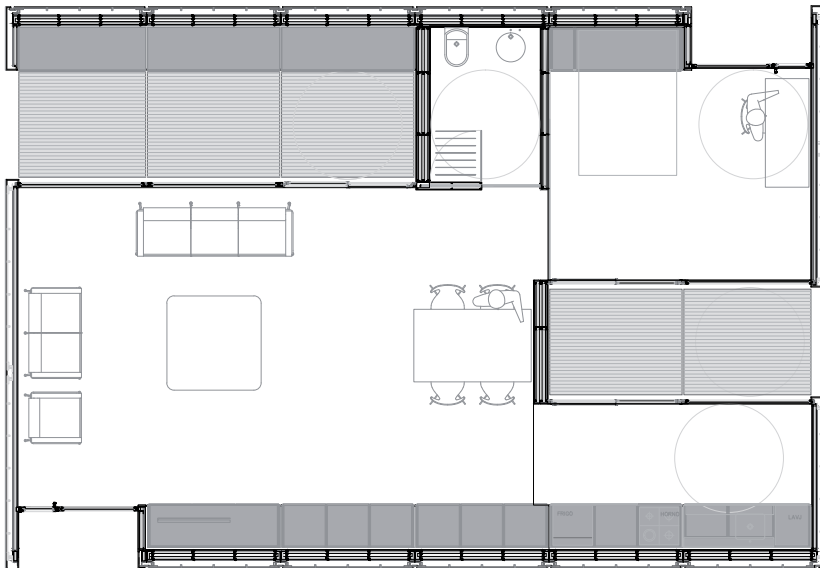

Movable elements

"()""+&,-.\$%&.,102.

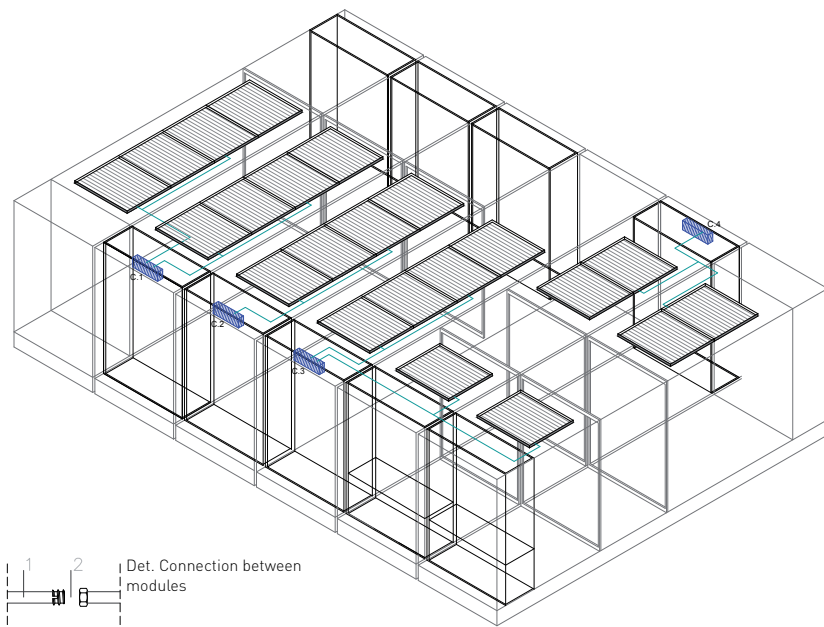
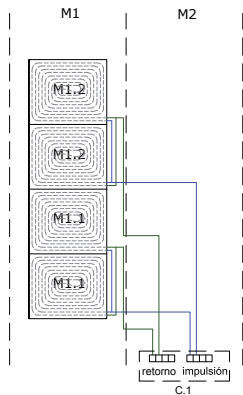

Isometric view.cooling ceiling scheme

- LEGEND:
- Schematic circuit
 - Distribution circuit
 - Return circuit
 - Cooling ceiling
 - Collectors

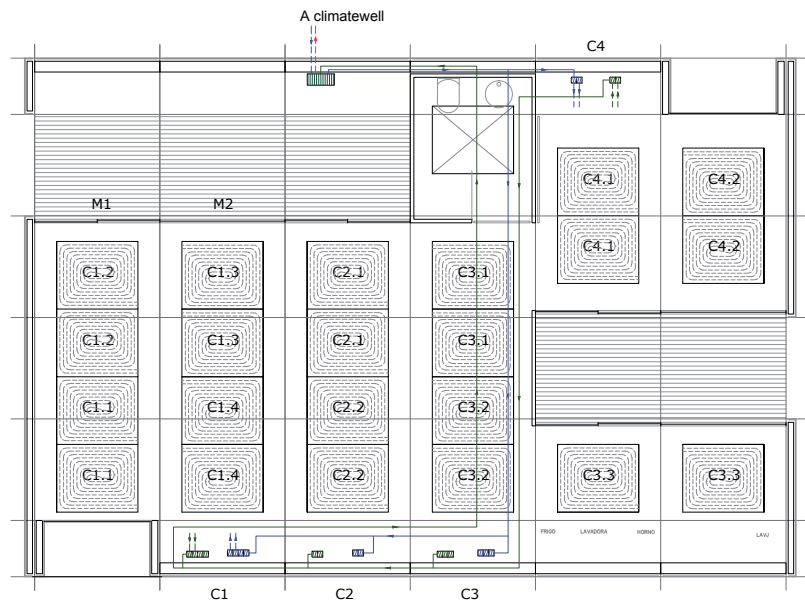

Roof Plan. Cooling ceiling

- LEGEND:
- Schematic circuit
 - Distribution circuit
 - Return circuit
 - Cooling ceiling
 - Collectors

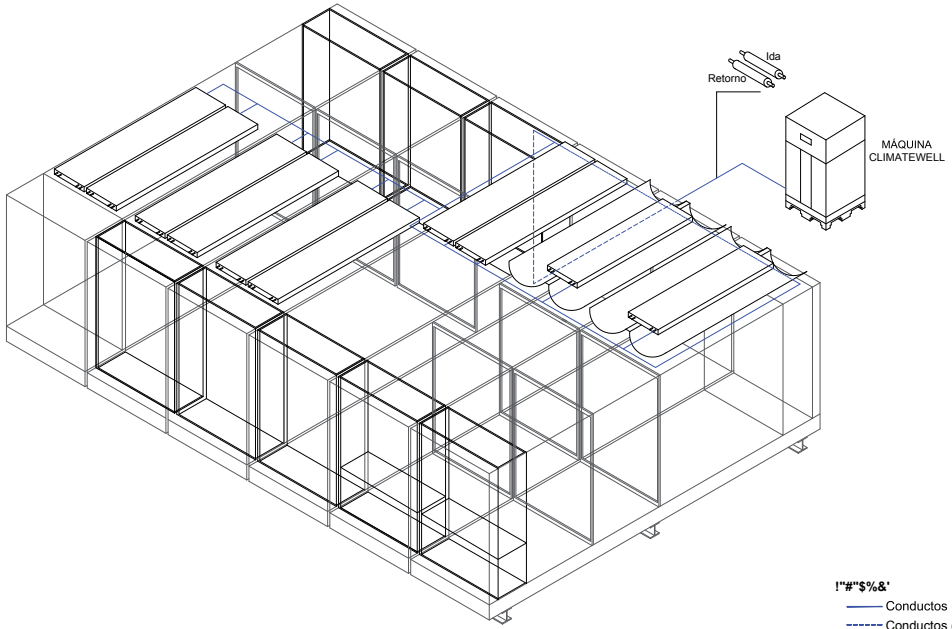

Isometric view. DHW installation scheme

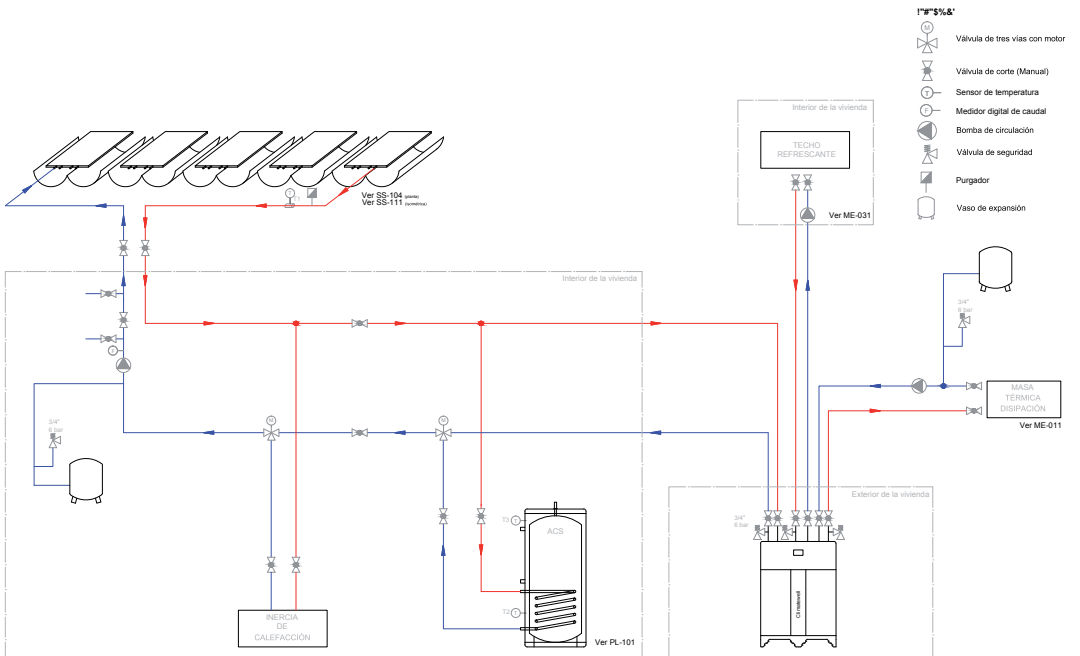

Hydraulic thermal installation scheme

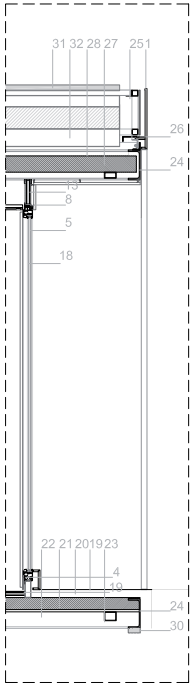

Glazing detail

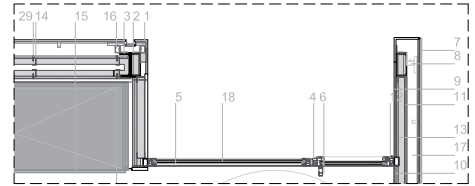
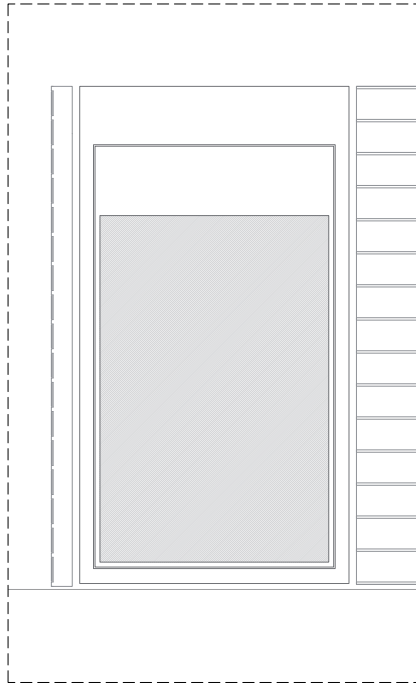

Horizontal section

GLAZING LEGEND

- | | |
|--|--|
| 01- Corian facade plate. 12 mm. | 19- living room ceramic paving (e=7 mm.) |
| 02- Aluminium profile | 20- OSB double board. 15 mm. |
| 03- Laminated steel profile. type UPN 160 | 21- Extruded polystyrene foam 120 mm. |
| 04- Aluminium frame | 22- OSB board. 15 mm. |
| 05- Double tempered glazing 6+6+8 | 23- laminated steel crossbeam. Tubular 60x80 mm. |
| 06- Frame Knob | 24- Laminated steel profile. type UPN 200 |
| 07- PV facade module plate | 25- Support for solar systems substructure. |
| 08- Laminated steel square profile 30x60 mm. | 26- Corian Rub off plate. 12 mm. |
| 09- Indoor Corian plate. 12 mm. | 27- Roof framework OSB board. 15 mm. |
| 10- Laminated gypsum double board 15 mm. (Placo) | 28- Self protected waterproof layer |
| 11- Laminated gypsum board 15 mm. (Placo) | 29- TTPC35 screw |
| 12- Elastomerix sealing material | 30- lamb wool insulation 24 mm. |
| 13- Rock wool insulation 120 mm. | 31- thermal collectors |
| 14- Galvanized steel W profile. M48 (Placo) | 32- thermal collectors' parabolic mirror |
| 15- Bed furniture | |
| 16- Steel frame. Facade fixing. | |
| 17- Air chamber | |
| 18- Double tempered glazing 6+6+8 | |

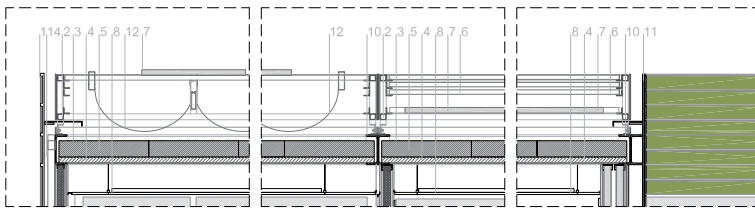

Longitudinal section

CEILING LEGEND

- | |
|--|
| 01- PV module facade plate |
| 02- Solar collectors support |
| 03- Self protected waterproof layer |
| 04- laminated steel square Tubular profile 30x60 mm. |
| 05- Roof framework OSB board. 15 mm. |
| pine wood joists. 80 mm. |
| OSB board. 15 mm. |
| pine wood joists. 80 mm. |
| 06- PV modules |
| 07- Thermal collector. |
| 08- Cooling Ceiling (UPONOR Gypsum) |
| 09- L.E.D. light IP65 |
| 10- Laminated steel profile. type UPN 200 |
| 11- Plywood phenolic board |
| 12- Thermal collectors' parabolic mirror |
| 13- Corian |
| 14- "L" laminated steel profile 120x80 mm. |

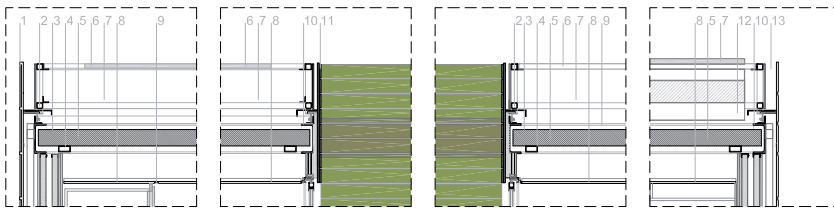

Cross section

TECHNICAL DATA OF THE HOUSE

Project name:

SML House

Construction area:

64 m²

Conditioned area:

50,79 m²

Conditioned Volume:

132 m³

ENERGY BALANCE*

+4.356 KWh/a

PV ENERGY PRODUCTION*

8.284 KWh/a

ENERGY CONSUMPTION*

Estimated electrical consumption:

77,3 KWh/m²a

Estimated energy consumption:

3.927 KWh/a

CONSTRUCTION ENVELOPE

Layers:

PV, Corian, Ventilation, Insulation infrared protection, Tyvek, Placo, Mineral wool, Placo.

SPECIAL AND INNOVATIVE SYSTEMS

Conventional kitchen oven heated with thermal oil.

COSTS

Construction Cost:

600.000 € (including qualified workforce costs).

Industrialized Estimate Cost:

120.000 € for a house type M for two people.

* SDE estimation

Information provided by the university

Living EQUIA

Hochschule Berlin University of Applied Science for Technology and Economics + Beuth Hochschule Berlin University of Applied Science for Technology + University of Arts Berlin, Germany

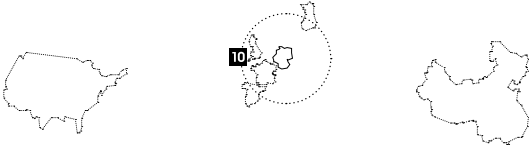

Nº.10 / 728,85 points

Contest 1: Architecture: 78,00 points.
Contest 2: Engineering and Construction: 61,00 points.
Contest 3: Solar Systems and Hot Water: 73,75 points.
Contest 4: Electrical Energy Balance: 106,81 points.
Contest 5: Comfort Conditions: 58,71 points.
Contest 6: Appliances and Functioning: 101,8 points.
Contest 7: Communication and Social Awareness: 64,00 points.
Contest 8: Industrialization and Market Viability: 46,00 points.
Contest 9: Innovation: 39,50 points.
Contest 10: Sustainability: 100,00 points.
Bonus Points and Penalties: 0,00 points.

Introduction and Main Objectives of the Project

The Berlin team "Living EQUIA" comprises more than 40 students, five professors and two staff members of the university. The diploma, bachelors and masters students from faculties of architecture, renewable energies, facility energy technology, economics, design, art and culture worked together as volunteers in the past two years. They are, for the most, responsible for the organization and implementation of this project.

Team Berlin refers to itself as "Living EQUIA". Students from the three universities of applied science in Germany's capital city put much thought into choosing this name. Living refers to "being alive" and dwelling. EQUIA an acronym for Ecologic Quality and Integration of Ambience: it stands for ecological and sustainable living in harmony with nature. All together, these words reflect the vision and motivation of the Berlin team to develop and foresee an energy-efficient and technologically innovative future for building and living.

Light, freedom, innovation, youth, sustainability and flexibility are the pillars on which Living EQUIA's architecture is founded.

Architectural Design

The two light axes help to relax the formality. They allow natural daylight into the living accommodation and have the effect of opening the structure visually from the exterior. The axes define the footprint, the interior floor plan and above all the shape and structure of the shell

of the building. The axes also help the house to face four points of the compass, allowing it to blend harmoniously with its immediate environment. The whole house, its technology and its materials only work as holistic visual and technological unit and communicate directly with one another and their environment at all times. This makes the house tangible for its inhabitants and creates a feel-good atmosphere of premium living quality.

Exterior design. One of the biggest challenges for the Living EQUIA house was to achieve a perfect symbiosis between modern architecture and innovative technology. Our team finally achieved a total integration of solar-active surfaces with the overall look of the structure. The PV and solar-thermal systems are sunk in the facade and are flush with it. The curtain-type, back-ventilated facade presents a closed and even building shell without projections or recesses, thus ensuring a totally homogeneous look.

Interior design. Demarcated by the light axes, the floorplan of the Living EQUIA house is divided in two sections: a generously dimensioned living space and the functional structures in the north eastern part. At the ground level, without any fixed partitions, 45m² of living space can be divided flexibly and individually into working, sleeping and dining areas. All of this space can be used and furnished freely, or zoned using room partitions (in the light axis area for example) to create places of retreat. On the second level, above the functional structures, more utility space is available as storage. The functional structure contains the kitchenette, the bathroom and, hidden behind it, the technology room.

The furnishing concept harmonizes with the architectural language of the house, and clearly focuses on the user's requirements. The individual design of the furniture combines modern purism with design, functionality and sustainability. Some of the furniture was designed and built on purpose for our prototypes, as for example the kitchenette.

The cross formed by the east-west light axis (on the house apex) and the north-south light axis defines the orientation of the building in relation to the environment and determines the interior design. These light axes are never shaded by any shading elements, so the time of the day and season is always noticeably inside, and daylight can be used for covering the living rooms lighting requirements. The best possible use of daylight contributes decisively to the energy efficiency of a building.

Construction and Materials

Sustainability means intelligent use of resources and necessitates a view of the whole life cycle of products such as building materials. It is important to pay attention to the certification and origin of the wood we use for a building. This is the only way to achieve a positive ecological footprint, thanks to low overhead for manufacturing, processing, transporting, maintenance, and finally, disposal.

We used wood, a domestic raw material and elementary building material, for the building shell, facade and furnishings - only adobe and adobe paints were used for the interior. However, this perfect symbiosis between modern architecture and innovative technology was a real challenge.

The Living EQUIA team placed much emphasis on using natural building materials, and doing without metals and plastics, wherever possible. The floors, walls and ceilings are mainly made of wooden building materials: solid wood and OSB boards, as well as wooden beams and slats were used as construction wood. We used ecological wood wool as the insulation material and wooden frames for the French doors. Finally, the rear ventilated facade is made of larch wood panels - wood

accounts for more than one third of the total weight of the house. On the interior, the walls are clad with adobe, a natural building material that ensures a pleasant internal atmosphere thanks to its ability to store humidity and absorb noise. The floor coverings are tiles of natural rubber which are extremely durable, and support recycling and are low-emission.

In order to achieve an effective and low-cost transportability of the living EQUIA house, as well as to enable fast erection and removal, the house relies on an element-centric construction. Due to the unusual geometry of the house, we decided to break down the house into plates which dimensions are suitable for loading side-by-side on a heavy goods vehicle.

The ground plate is made up of eight elements, each of which is framed by glue-laminated wooden beams and supported by spot foundations. The outer wall plates are mounted directly on the outer beams of the ground plates. The load bearing layer of all wall and roof elements is implemented by means of solid wood plates. At both sides of the north-south light axis there is a three-hinged steel frame that rests on its own separate foundations. The horizontal reaction forces of the three-hinged frame are counteracted by tie members below the ground plate. The roof elements whose load bearing layer is just 125 mm thick, stretch from the gable walls to the three-hinged frames and are directly inserted into and connected with the steel section at this location. The walls have a projection depth of about 50 cm and are constructed in a similar way to the roof elements. However, the solid wood plates are just 85 mm thick. All the constructional parts of the house are transportable modules, although some wall elements are "interrupted" by doors and windows.

The different modules of the Living EQUIA house, from which the floors, walls and ceilings are built, use a similar - but not identical - construction:

- The floor modules use double wooden finjoists paneled on both sides with OSB boards with a 24 cm layer of wood wool in-between. More OSB boards and finally the natural rubber tiles are laid on top of them.
- The sections of the wall comprise 8.5 cm of solid

plywood board clad on the inside with the adobe plates. On the exterior, there is once again a 24 cm wood wool insulating layer on which 15 mm water-proof MDF boards are fitted.

For the ceilings, we used 12.5 cm plywood boards. Walkable 24 cm wooden insulating plates are fitted directly onto them and anchored on the solid wood plates by means of screw connections. Corrugated metal sheeting tops this as a water-bearing layer.

Interior Comfort, HVAC and House Systems

The development of an efficient energy concept starts with the house design. We implemented several essential measures in the building phase in order to minimize energy consumption: an effectively insulated and air-tight building shell keeps heat loss to a minimum. Other passive measures are supported by the unique characteristics of the adobe clad walls: the phase changing materials built into the Lebast adobe building slabs can absorb an enormous amount of heat to protect the building against overheating in the summer. Additionally, adobe is a moisture regulating material that prevents needing an active humidification or dehumidification of the air.

The active energy requirement still needed to operate the house (for, say, heating and cooling) is provided by the sun. The solar collectors built into the south facade produce heat and the photovoltaic systems generate solar power to run the remaining climate control components.

Together, the solar thermal system, the heat pump, the ventilation unit, the adobe walls, and the cooling and heating ceilings ensure pleasant temperatures and optimum moisture levels in the house - and use a minimal amount of energy in doing so.

Solar System

Both PV systems and the solar thermal collectors become peer elements of the facade design thanks to their dark appearance and the fact that they are fitted

flush with the wooden panels. Living EQUIA thus uses a unique approach in integrating photovoltaics and the building.

In order to generate electric power, the Living EQUIA house integrates two photovoltaic systems - one is implemented as a roof-borne PV system, while the other is integrated in the sun protection, in front of the south and west facades.



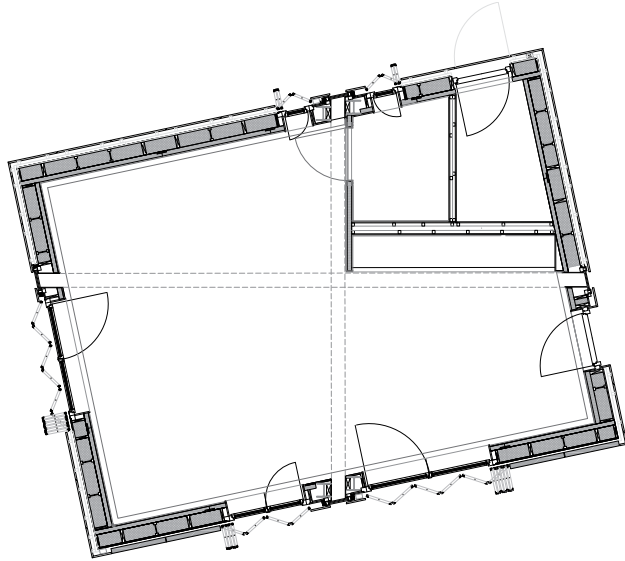

Floor plan

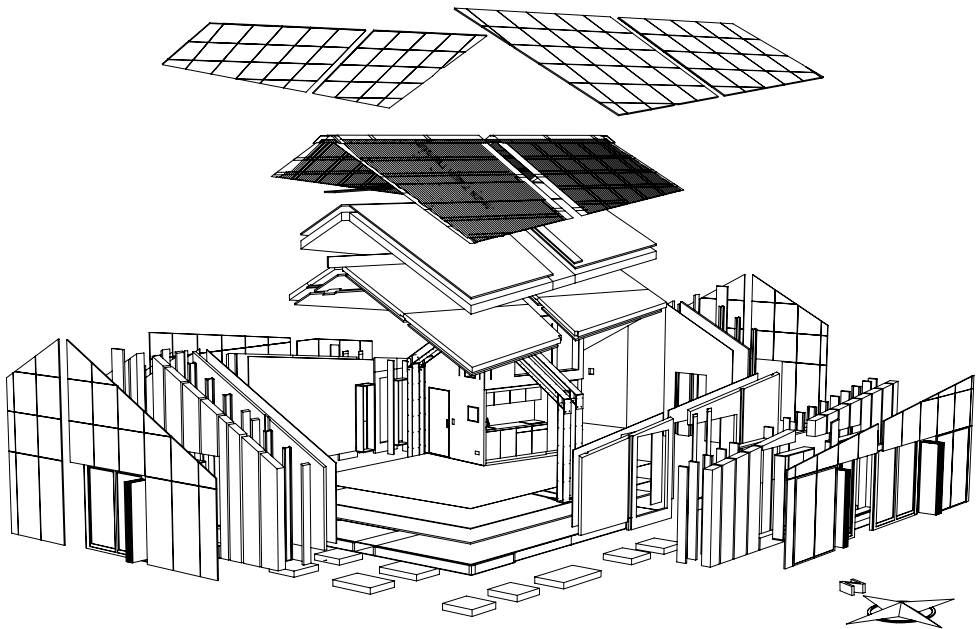

Blow up

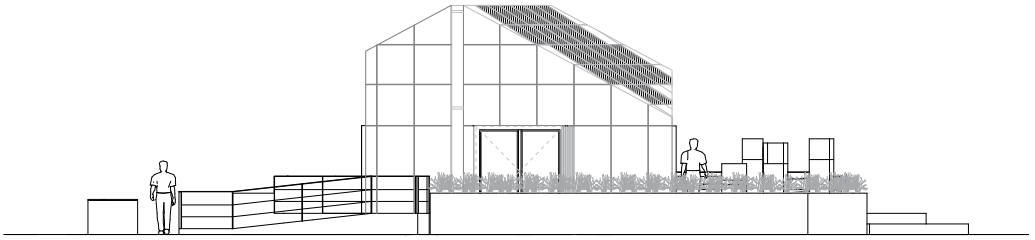

East elevation

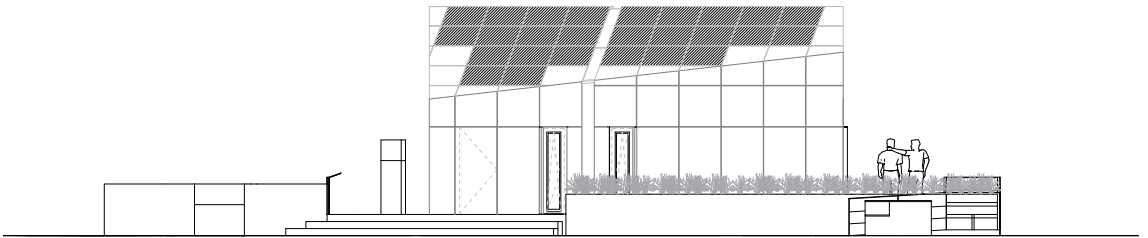

South elevation

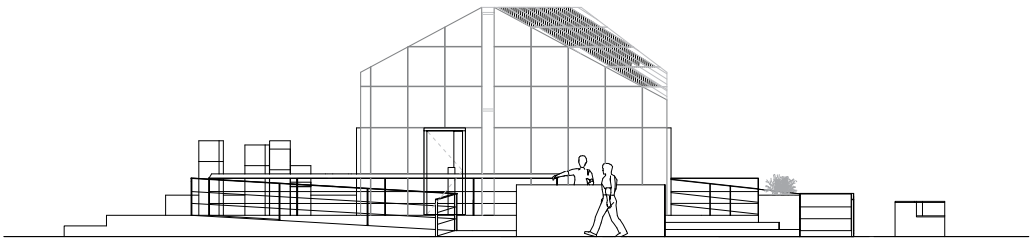

West elevation

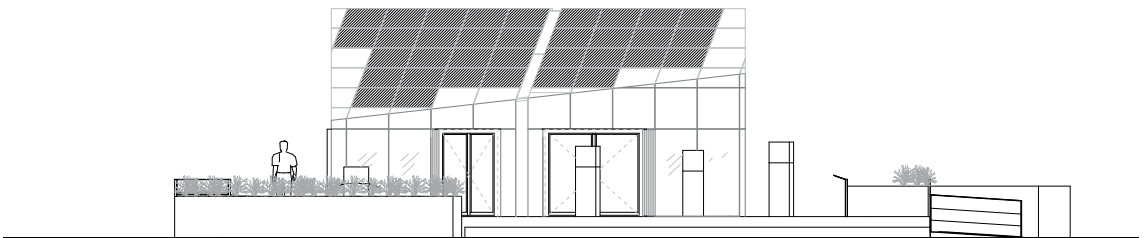

North elevation

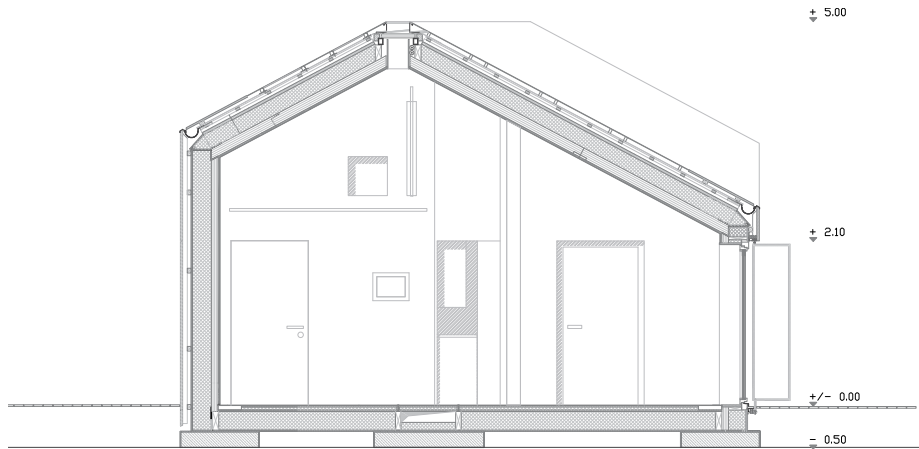

Transversal section

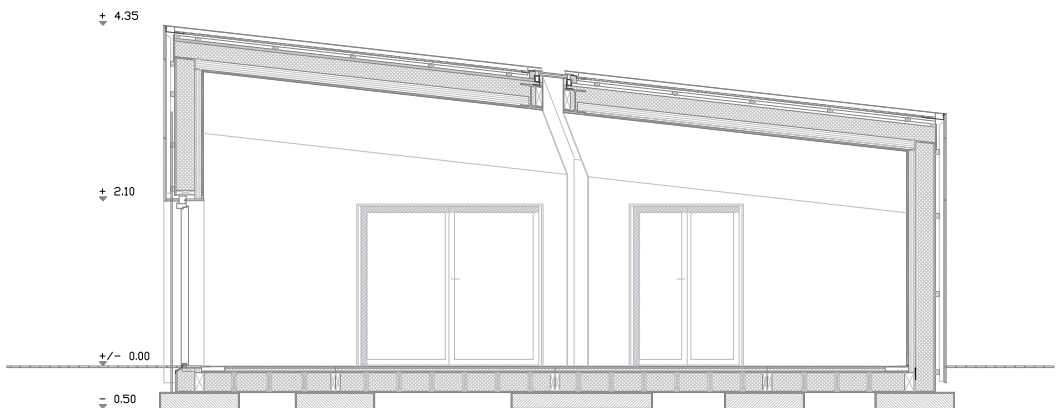

Longitudinal section

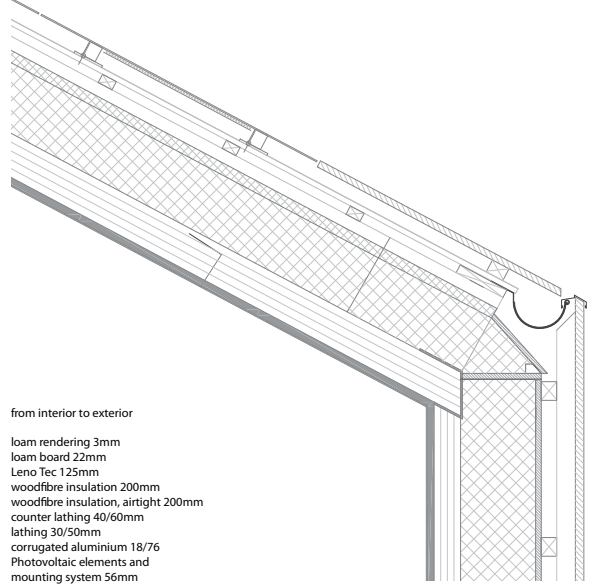
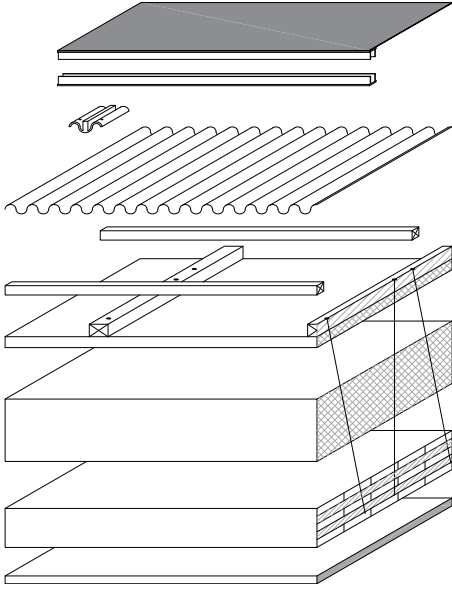

from interior to exterior

- loam rendering 3mm
- loam board 22mm
- Leno Tec 125mm
- woodfibre insulation 200mm
- woodfibre insulation, airtight 200mm
- counter lathing 40/60mm
- lathing 30/50mm
- corrugated aluminium 18/76
- Photovoltaic elements and mounting system 56mm

Blow up roof

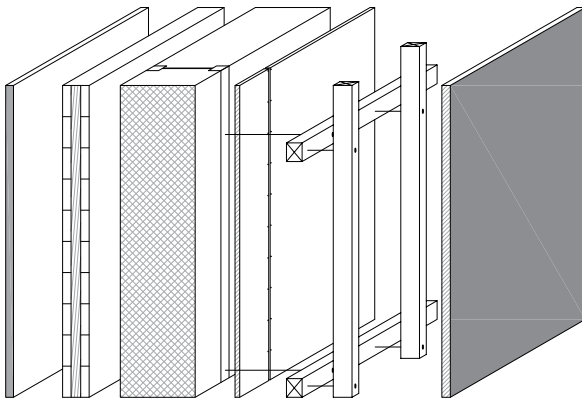

from interior to exterior

- loam rendering 3mm
- loam boards 22mm
- Leno Tec 85mm
- woodfibre insulation 240mm
- OSB-board 18mm
- lathing 40/60 and 30/50
- singed larch-boards 27mm

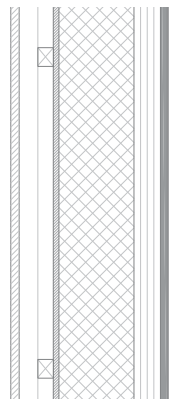

Blow up wall

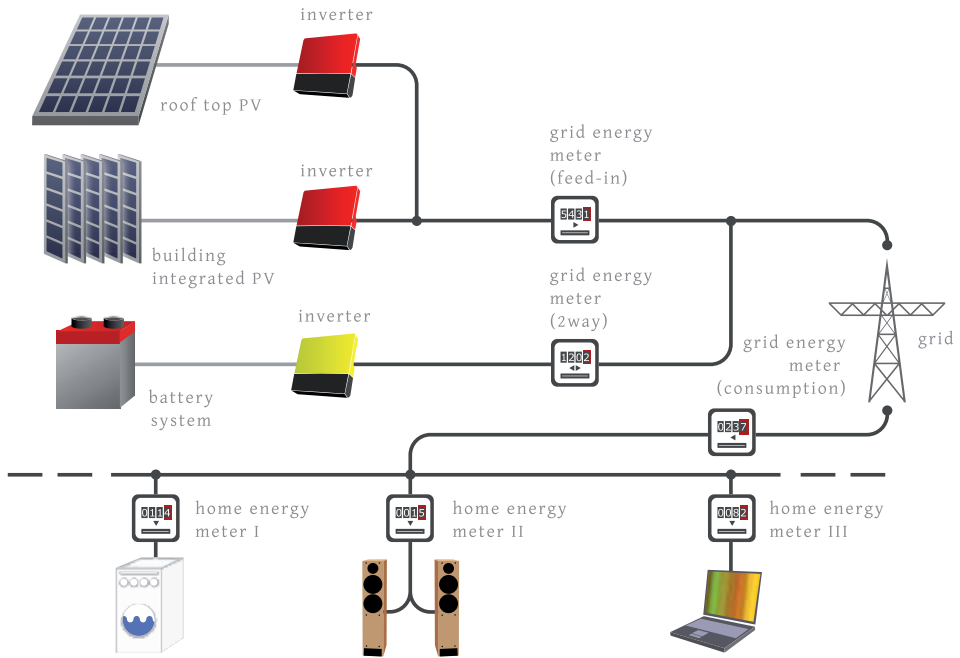

Conditioned space

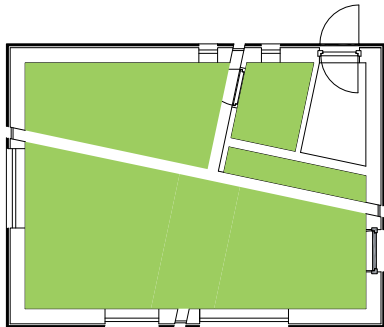

gross floor area	74.00m ²
total living space	56.40m ²
sleeping living dining working	49.00m ²
bathroom	3.70m ²
technical services room	3.70m ²
2. floor storage area	9.70m ²
construction area	18.10m ²

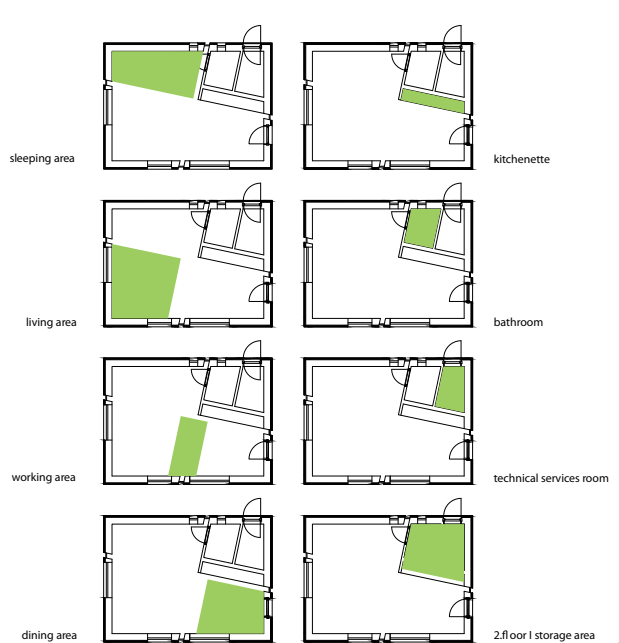

TECHNICAL DATA OF THE HOUSE

Project name:
Living EQUIA

Construction area:
74,00 m²

Conditioned area:
52,82 m²

Conditioned Volume:
315,5 m³

ENERGY BALANCE

Estimated energy balance:
+4.077 kWh/a

CO₂ Emissions:
2.537 kgCO₂/a

Estimated energy production Madrid:
8.306 kWh/a

Photovoltaic system:
Total installed PV power:
5.7 kWp

Types of PV Modules:
Roof: 11 PV Modules SOLON Black 130/04 135Wp
Inverter Diehl AKO 4800TL
Façade louvers: twenty 6" solar cells from Q-Cells

ENERGY CONSUMPTION

Estimated energy consumption Madrid:
4.229 kWh/a

Estimated electrical consumption Madrid:
80,10 kWh/m²a

Characterization of energy use:
Appliances 1.803 kWh/a
Multimedia 267 kWh/a
Lighting 589 kWh/a
Heating+cooling 824 kWh/a
Building Automation and Control Systems 744 kWh/a

CONSTRUCTION ENVELOPE

Insulation types (type and thickness):
insulation glass wool 30cm (roof, floor, north and south wall)
vacuum insulation 8cm (west and east wall)

Constructive Systems thermal transmittance:
North and south wall 0,14 W/m²K
East and west wall 0,14 W/m²K
Floor 0,13 W/m²K
Roof 0,13 W/m²K

Component	Area m ²	Orientation (slope ¹ /azimuth ²)	U-Value W/(m ² *K)	Window Fraction %
Outside wall east	22,8	90/-102	0,14	6
Outside wall south	21,4	90/-12	0,14	50
Outside wall west	22,0	90/78	0,14	31
Outside wall north	25,5	90/168	0,14	17
Roof south	36,8	31,5/0	0,13	3,3
Roof north	28,1	32,8/180	0,13	3,6
Roof horizontal	2,7	0	-	100
Floor	74,0	0	0,13	0

SPECIAL AND INNOVATIVE SYSTEMS

The innovative photovoltaic solar shading system consists of movable vertical louvers that combine photovoltaic energy generation technology by Sunovation with shading elements from Colt to prevent the interior of the house from overheating. The terrace doors in the west and south feature a total of 16 vertical louvers carrying each twenty 6" solar cells from Q-Cells each. The nominal power of this system can be indicated with 1,1 kWp.

Due to the varying orientation of the louvers during the day, the system is split up in three subsystems, each of one connected to its own inverter: a StecaGrid 300.

COSTS

Construction Cost:
276.727 €

Industrialized Estimate Cost:
200.000 €

Bamboo House

Tongji University, China

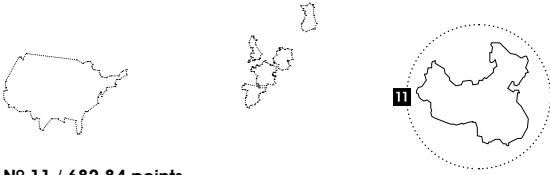

Nº.11 / 682,84 points

Contest 1: Architecture: 72,00 points.
Contest 2: Engineering and Construction: 57,00 points.
Contest 3: Solar Systems and Hot Water: 64,00 points.
Contest 4: Electrical Energy Balance: 109,37 points.
Contest 5: Comfort Conditions: 75,49 points.
Contest 6: Appliances and Functioning: 99,48 points.
Contest 7: Communication and Social Awareness: 36,80 points.
Contest 8: Industrialization and Market Viability: 46,00 points.
Contest 9: Innovation: 33,20 points.
Contest 10: Sustainability: 85,00 points.
Bonus Points and Penalties: 4,50 points.

Introduction and Main Objectives of the Project

The Bamboo House aims to create a beautiful and well-designed house which can generate enough thermal and electrical energy to meet the needs of daily life, while maintaining a comfortable indoor environment. It is inspired by the vernacular houses of south china and traditional Chinese domestic culture, which value the harmonious co-existence of people and environment. We focused on three elements of traditional Chinese housing: the courtyard facing the river; traditional curved roof (called Fanyu), and the use of bamboo. These elements do not simply reflect Chinese's culture of living; they also significantly benefit our solar system.

Architectural Design

The river near our lot deeply influenced the shape of our solar house, informing its "L" plan. The courtyard is situated between the rooms and the water, connecting the bamboo house to the river. Indoor living spaces are arranged around the courtyard, so as to open the space of the house, despite its relatively small footprint. So-called "gray spaces" (such as porches and galleries commonly used in gardens and buildings) are very important to the Chinese architecture tradition. Similarly, the bamboo corridor provide a comfortable, interesting resting experience. It represents a transitional space between indoor and outdoor, which blurs the boundaries between human and nature –somewhat paralleling the doctrine of the Mean in traditional Chinese philosophy. The courtyard is oriented according to the prevalence of southwest winds in Madrid, greatly improving the

quality of the outdoor environment. The curved roof is one of the most well-known features of traditional Chinese architecture; we can link it to the philosophy of Dao. As opposed to the dome or the spire in western architecture, the curved roof provide a soften silhouette who reflects an harmonious relationship between the building and the universe. To another extend, the curved roof improve the efficiency of PV panels (uplifting wind below the panels). It also exploits the advantages of natural drainage. Considering a maximum height limit of 5.5 m, the shape of the curved roof is used to enlarge the area of PV panels. PV panels are fixed on the curved roof as well as on the south facade. They can generate power up to 8 Kw – twice enough to cover the needs of an average family. Excess electricity is used to heat domestic water, or is delivered to the grid.

Construction and Materials

Bamboo is viewed as a symbol of traditional Chinese values. It is a totem of the harmony between nature and human beings. Chinese ancients used to describe the plum, the orchid, the bamboo and the chrysanthemum as "four gentlemen"; pine, bamboo and plum as "three friends in winter". People think the deepness of its roots denotes resoluteness. Its tall, straight stem represents honorability; its hollow interior, modesty. Its clean, external appearance finally exemplifies chastity.

Our prototype is a totally bamboo-made house: both the interior and the exterior elements of the decoration are made of bamboo. The modules are made of bamboo pipes that are strung together and fixed to a light steel keel.

It forms a natural facade that protects the waterproof breather membranes and louvers. Bamboo curtains are used in the inside – by contrast with the exterior facade, they inspire a certain delicacy emanating from within the house.

All the beams, columns and other load-bearing components are mainly made of Moso bamboo – a common type of bamboo in south China, which grows very fast. The construction components are articulated with steel components, greatly enhancing the structural integrity of the house. Surprisingly maybe, an analysis of the structure reveals that the Bamboo House comply with national laws and regulations about earthquake hazards reduction.

A totally prefabricated system ensures a quick and convenient construction process. Bamboo pipes are bundled together to form a column or beam, and are articulated with steel components. Phase change materials, vacuum insulation panels and triple-skin glazing are prefabricated for several wall components and can be fixed on the bamboo frame one by one.

Interior Comfort, HVAC and House Systems

Phase change material (PCM) is a substance who has a high heat of fusion. It melts and solidify at certain temperatures, and is capable of storing or releasing large amounts of energy. In our bamboo house, phase change materials are used in two passive and active ways.

Active way: 192 pieces of PCM squares are installed in four rectangular ventilation ducts under the bedroom's deck. These four ducts, which work like air-conditioners, can regulate room temperature actively and reduce the cooling and heating load of HVAC system.

Passive way: 32 Kg of PCM thermal control mortar are rendered on the interior walls. When the temperature of the room exceeds its phase change point, heat will be absorbed, preventing the temperature from rising further. It also reduces the cooling and heating load of HVAC system.

The vacuum insulation panel (VIP) is a technologically advanced product that combines high R-value in a relatively thin panel. In comparison, in order to obtain similar insulation performances, traditional insulation materials would have to be seven or ten times thicker. The biggest concern with VIP, however, is its fragile surface. In our Bamboo House, a normal polyfoam is installed on both sides of the VIP as a protective covering.

Triple-skin glazing is made of vacuum layer and cavity layer. Obviously, windows can be a net heat supplier during the day with appropriate U-value and solar heat gain coefficient (SHGC). Given the influence of the properties of windows, the Bamboo House employs the glazing with U-value of $0.8 \text{ W} / \text{m}^2 \cdot \text{K}$ and SHGC of 0.7.

The Bamboo House is intended to be comfortable and high-efficient. Such high quality comfort objectives can be met by respecting several criteria which mainly apply to the quality of every components and elements of the building:

- For high thermal comfort, all U-values of the windows and walls are chosen in "Passive House" quality (walls U-value $\leq 0.1 \text{ W} / \text{m}^2 \text{K}$; windows U-value $\leq 0.8 \text{ W} / \text{m}^2 \text{K}$). High-standard VIP (vacuum insulation panels) can ensure the reduction of the thermal bridge.
- The integration of the phase change material (PCM). This technology help reducing cooling loads, and buffers temperature peaks.
- Bamboo House's HVAC system with heat recovery maintains a comfortable indoor temperature, within 22-25°C. The solar thermal collectors provide a comfortable 50°C water, in sufficient quantity to meet daily usage.

Every feature of the Bamboo House was carefully thought for specific purposes, in order to improve home functionality, as well as comfort for the residents.

Both the HVAC system with heat recovery and the solar thermal collector system are designed in integration. A certain amount of waste condensing heat can be used to heat sanitary water, so it both cools the space and supplies hot sanitary water simultaneously.

The solar thermal collector system can meet all the daily demands in hot water on sunny days. When the weather

is not good, the multi-function HVAC system can run automatically as an alternative heating source. If there is no need for cooling, the HVAC system will become an air-source heat pump mainly supplying hot sanitary water. The COP of the whole system is 3.5. By using these energy conservation technologies, our Bamboo House can save about 80% in energy consumption. Saving 1kWh electricity equals a reduction of 0.977kg CO₂.

We considered daylight as one of the most important lighting resources, along with LED lamps by KNX/EIB smart lighting control system. The tension between advanced lighting control systems and the traditional features of Chinese luminaries shows the spirit of the "human model" for Chinese people : both making independent choices and seeking a common ground while putting aside differences. A low-carbon (LC), sustainable housing ensuring safety in daily life and routine operations can be achieved while providing a comfortable lighting environment.

Solar Systems

Our objective was to design a PV system that would optimize energy generation, while matching the traditional characteristics and aesthetics of Chinese architecture. We wanted the Tongji Team's House to be poetically rich: a pictorial splendor, not a power plant.

The design of the roof is inspired by the concave upward shape of ancient palaces. It was a real challenge to install PV panels and select proper components matching these architectural characteristics. Most solar power systems are identifiably separate from the rest of the house - our design had to overcome this. Furthermore, we wanted to maximize the power that the photovoltaic system would deliver to the house, reducing its dependence on externally-generated, carbon-heavy energy. This would provide residents with freedom in using all of the house's amenities with peace of mind in terms of energy independence.

Consequently, PV panels are installed on two south-facing roof slopes and the south facade, so to provide

an integrated vision from an architecture sight. Each module is 300 mm × 820 mm, with a peak power of 33 W and its conversion efficiency is 13.4%. PV installation area corresponds to 68.8 m² on the rooftop and 10 m² on the south facade. The overall installed capacity is about 10 KW.

For solar thermal system we used evacuated solar collectors, which can operate in Madrid in both winter and summer. Solar collectors use twin-glass selectively coated solar tubes as the solar absorber; the system is extremely stable. The evacuated tubes absorb sunlight and convert it into usable heat. The heat inside the evacuated tubes is transferred up into the insulated black box at the top of the tubes, which contains a copper heat exchanger. An electronic controller measures the temperature of the solar collector and of the water in the bottom of the storage tank. If the collector is hotter, it means that heat is available. The controller supplies power to a circulation pump which pushes water through the collector heat exchanger, back to the storage tank. Even on rainy or cloudy days, if the solar collector cannot start working and the temperature of hot water in the tank is lower than the setting value, the heat pump will be operated automatically. During the summer, the heat pump can provide cold energy for indoor spaces and hot water for domestic use. During the winter, the heat pump can offer heat energy for rooms and hot water for domestic use. In short, no matter how the weather is like, the solar collectors and the heat pump can provide enough hot water.

Based on the specifications provided by the Solar Decathlon Europe for the competition, and an average daily usage of 200L, the daily energy requirement is only about:

$$43^{\circ}\text{C} - 15^{\circ}\text{C} = 28^{\circ}\text{C} \text{ temperature rise,}$$
$$28^{\circ}\text{C} \times 200\text{L} = 5600 / 859.8 = 6.5\text{kWh per day.}$$

A 22 tubes solar collector is therefore sufficient. If the weather is good, it will provide nearly all the hot water needed, requiring little energy from the heat pump.



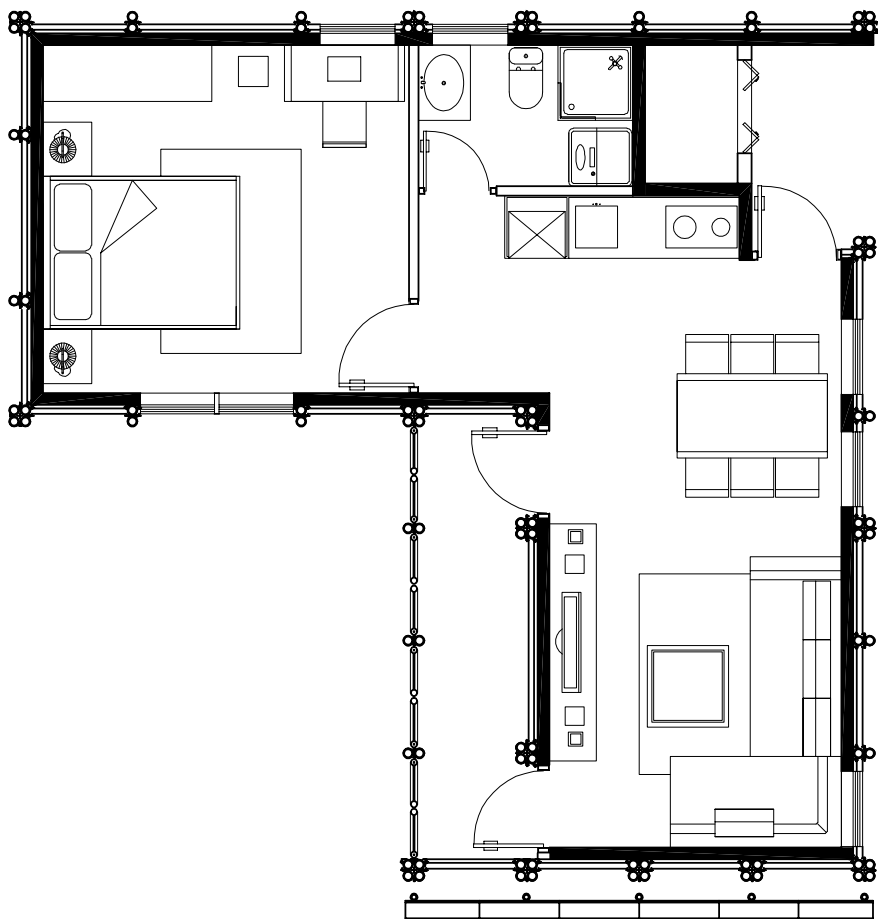

Floor plan

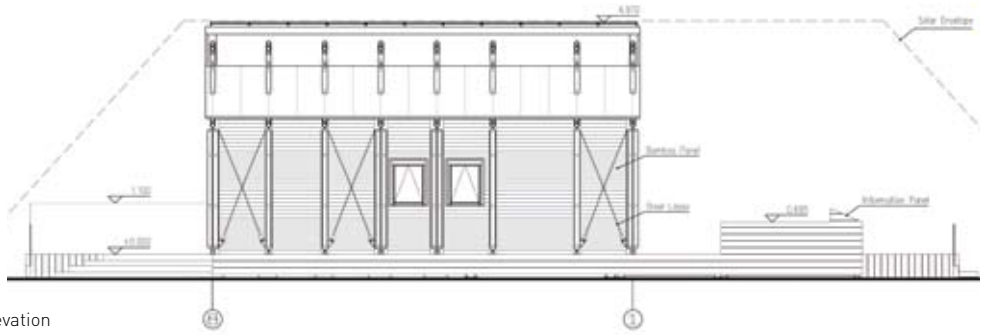

North elevation

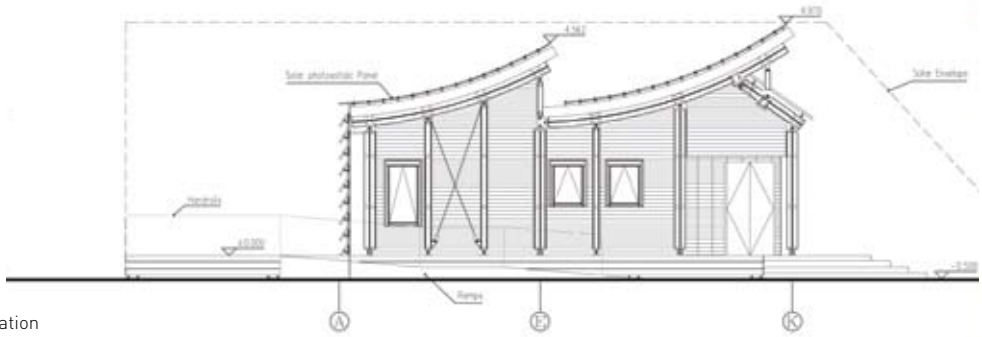

East elevation

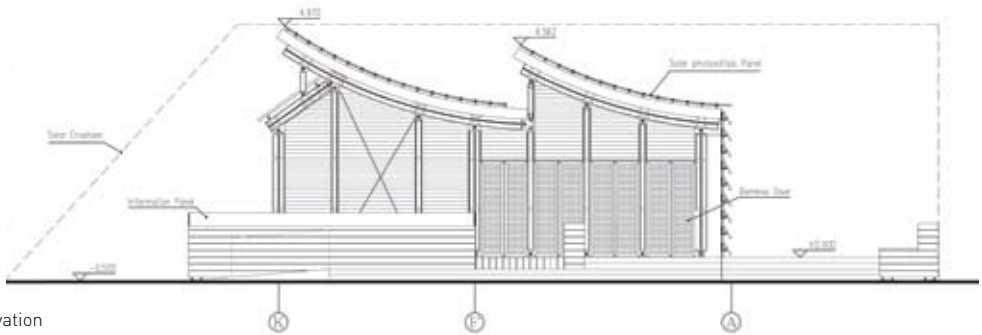

West elevation

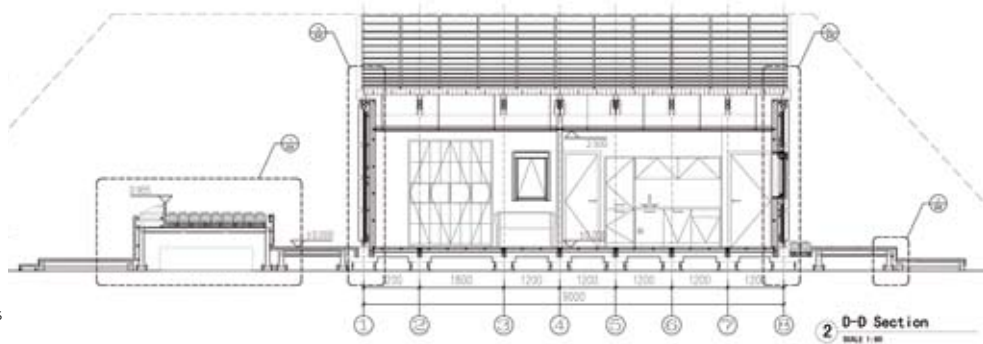
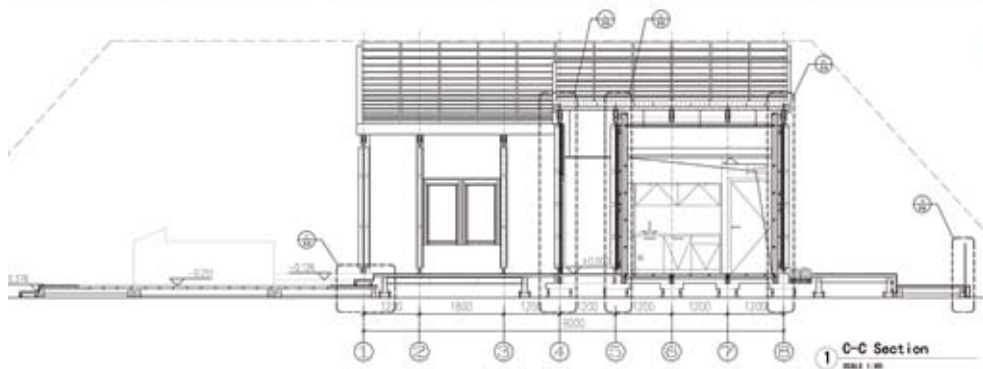
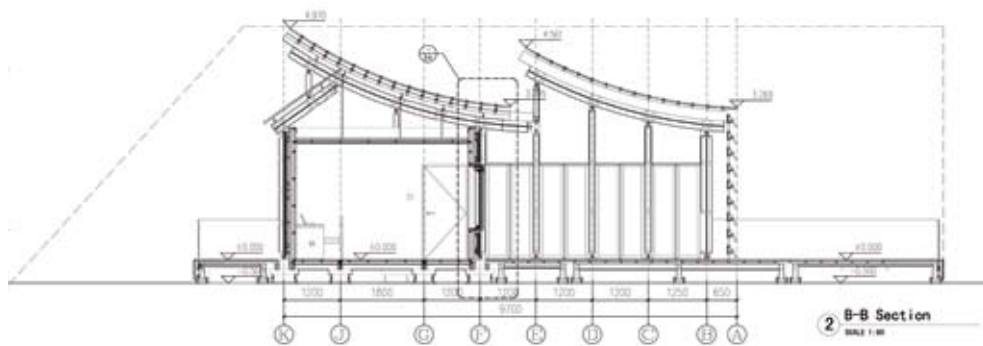
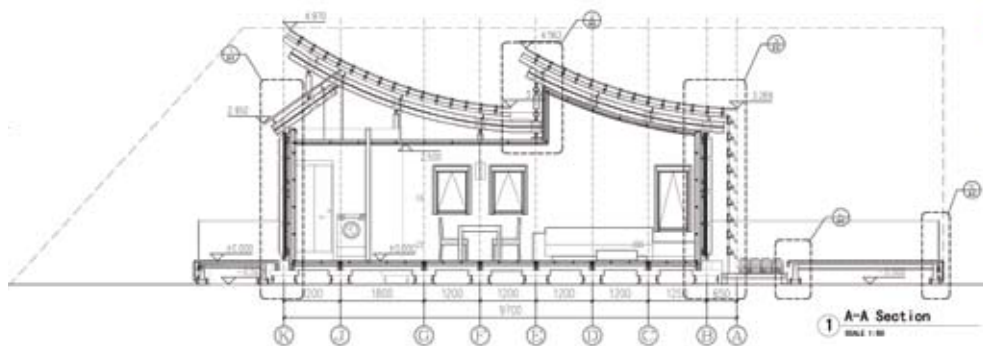

Sections

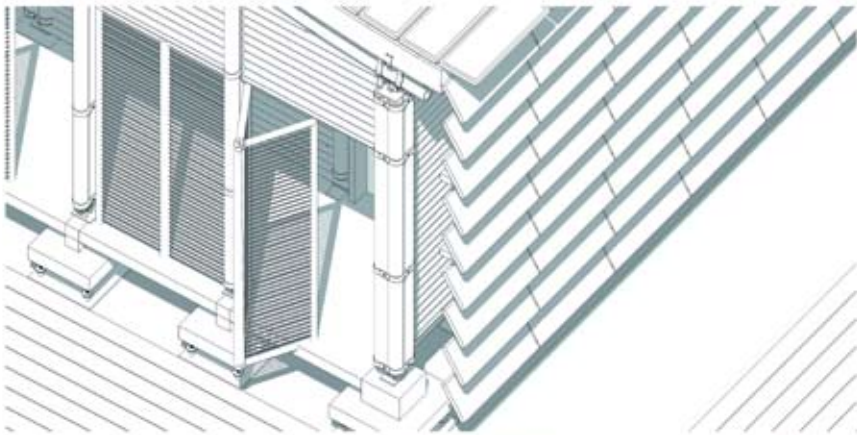
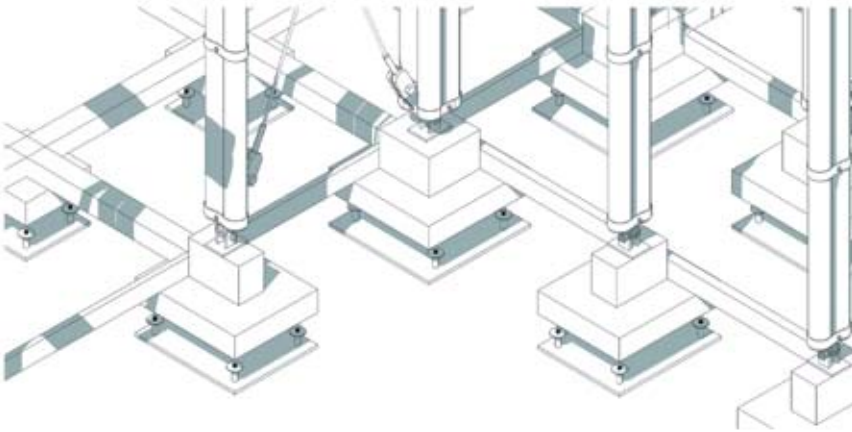
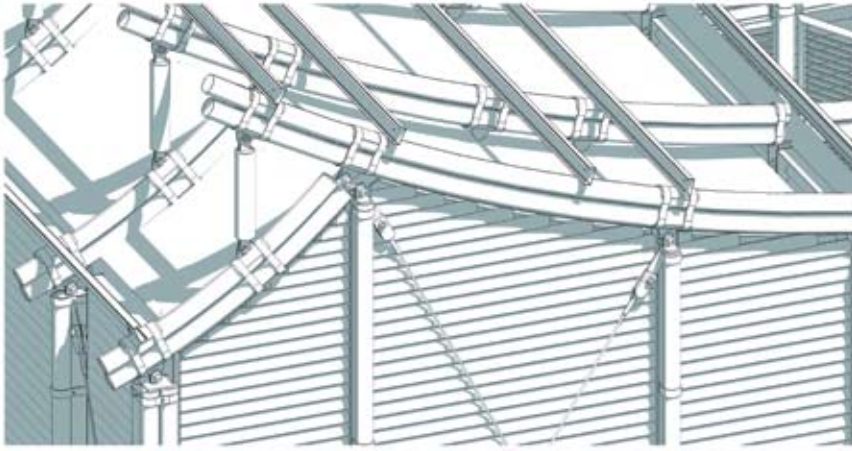

Axonometric detail

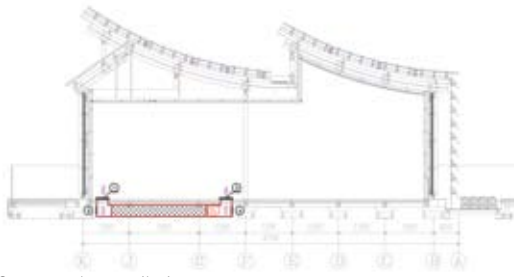

Summer day ventilation

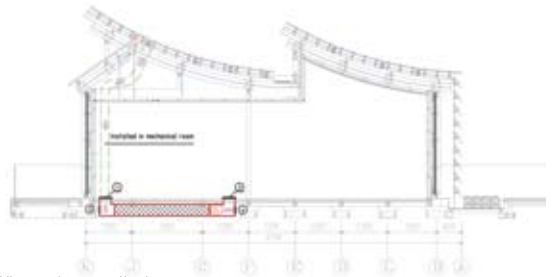

Winter day ventilation

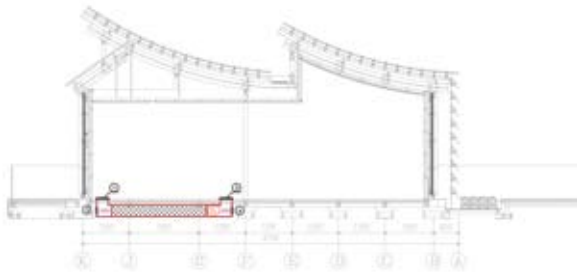

Summer night ventilation

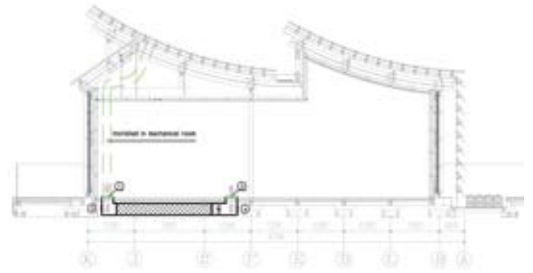

Winter night ventilation

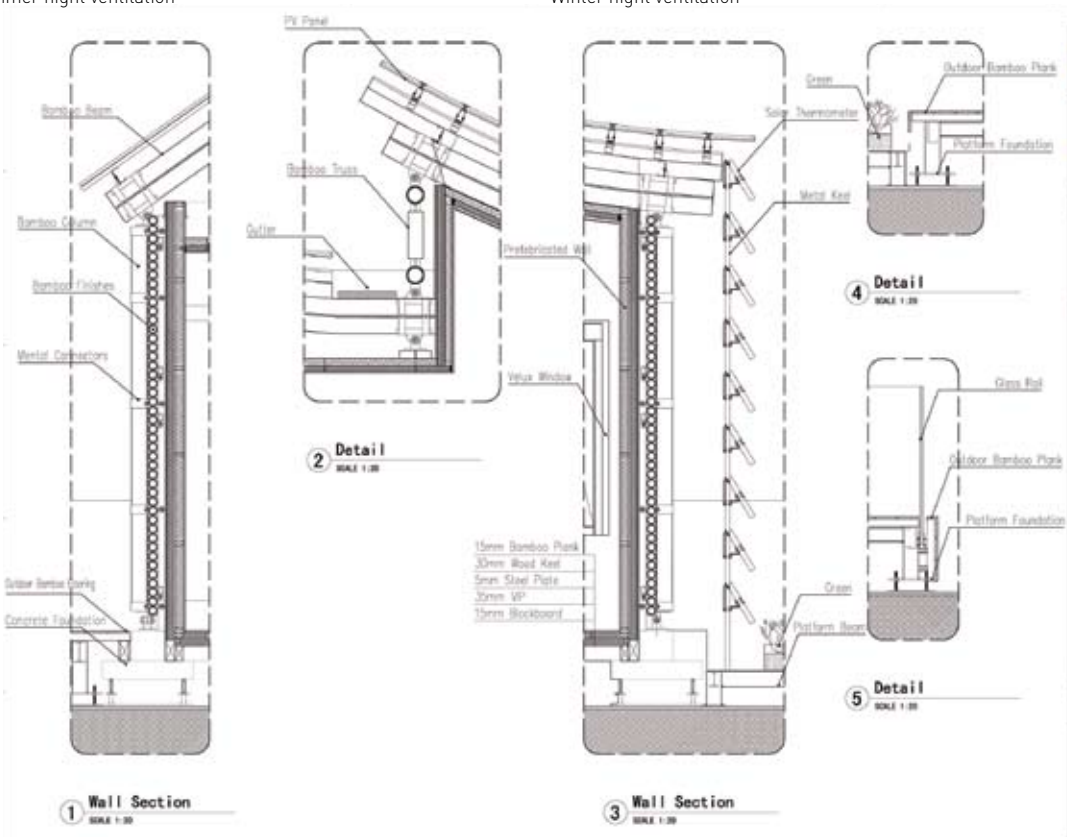

Details wall section

TECHNICAL DATA OF THE HOUSE

Project name:
Bamboo House

Construction area:
55,90 m²

Conditioned area:
42 m²

Conditioned Volume:
90 m³

ENERGY BALANCE

Estimated energy balance:
2.824,4 kWh/a

CO₂ Emissions:
7.200 kgCO₂ /a

Estimated energy production:
7.680,4 kWh/a

Photovoltaic system:
Total installed PV power:
10 kW

Types of PV Modules:
JETION Black Series (JT030SA08) solar panel
mono-crystall silicon

ENERGY CONSUMPTION

Estimated energy consumption:
4.856 kWh/a

Estimated electrical consumption:
215 kWh/m²a

CONSTRUCTION ENVELOPE

Insulation types (type and thickness):
Vacuum Insulation Panel, 35mm.
Knauf Insulation panel, 20 mm.

Constructive Systems thermal transmittance:
Floor, ceiling, façade 0.1 W/m²K
Windows 1.2 W/m²K

SPECIAL AND INNOVATIVE SYSTEMS

Passive strategies: PCM wallboard in interior walls
Active strategies: PCM ventilation tunnels under the
duck of the bedroom

COSTS

Construction Cost:
200,000 €

Solarkit

Universidad de Sevilla, Spain



Nº.12 / 677,82 points

Contest 1: Architecture: 84,00 points.
Contest 2: Engineering and Construction: 52,00 points.
Contest 3: Solar Systems and Hot Water: 55,21 points.
Contest 4: Electrical Energy Balance: 111,54 points.
Contest 5: Comfort Conditions: 89,39 points.
Contest 6: Appliances and Functioning: 95,14 points.
Contest 7: Communication and Social Awareness: 22,89 points.
Contest 8: Industrialization and Market Viability: 41,30 points.
Contest 9: Innovation: 42,35 points.
Contest 10: Sustainability: 85,00 points.
Bonus Points and Penalties: -1,00 points.

Introduction and Main Objectives of the Project

Solarkit is a dismountable, self-sufficient, low-cost house. Its innovative architecture provides all the amenities of a permanent house, while featuring a removable system whose modular, lightweight components are both functional and flexible. Solarkit is a self-sufficient house system (it produces three times the energy it consumes) which adapt to urban as well as rural locations. It can be implanted as a new construction, or as an extension of pre-existing structures in all sorts of territorial contexts.

Architectural Design

Instead of conceiving the house as the sum of its rooms, or as the sum of its walls and ceilings, we deconstructed it according to daily, domestic activities such as eating, sleeping, watching TV, bathing, storing, and so forth. We associated each of these actions with a piece of furniture. Each piece of furniture is manufactured using modular dimensions (a bit bigger than a wardrobe), so they can be assembled and fit each other perfectly. It more or less works as a do-it-yourself manual: the simple combination of furniture elements enables the user to create living spaces, sleeping spaces, hygiene spaces, etc.

This way, the house can be adapted to different needs, to different type and number of users and to different locations. In that respect, it also offers potential solutions for emergency or temporary architecture needs. We used furniture instead of pre-established partitions as

the key element of our interior design. This technique produces a new type of house based on one single open space: non-fixed areas are displayed and connected ambiguously, using pieces of furniture instead of walls in order to delimitate the rooms. The result is a fluid, flexible, non-hierarchical and multipurpose space which can easily be adapted to different uses. Although we used contemporary construction technologies, Solarkit also borrows from traditional housing ideas or techniques such as compactness, reduction of exterior openings, use of patios, gradation of spaces between the exterior and the interior, integration of passive conditioning systems, etc.

Exterior design. Two decks provide intermediate spaces between outdoor and indoor, extending the interior space of the house. On the south side, a "public" terrace gives access to the house. On the west side, a "private" veranda links the house to the garden, where one can read or rest. In order to be consistent with the construction system, the facade is vertically divided according to the joints between the pieces of furniture, making their size and location obvious. Elevations are as abstract and minimal as possible, so to enhance the contrast between a very simple exterior and a complex, rich interior.

Interior design. Without usual fixed partitions, a unique, flexible space is created. Among the different configurations our 'furniture kit' system can provide, we proposed a house designed for four users. Two main areas are functionally and spatially connected. A communal area is linked to the entrance hall.

A second area leads towards the bedroom; it is less accessible, and therefore more private. A workstation is located in-between.

Construction and Materials

Construction and industrialization systems. Every “piece of furniture” of the kit integrates structure, equipment and envelope. We used wood as the main construction material because of its insulation properties, and highly recyclable features. The dimensions of every element are harmonized according to a 3M (30 cm) module’s reference (both horizontally and vertically).

Solarkit works as a “plug and play” system: each furniture element is a constitutive piece of the whole structure. They can be connected, disconnected or replaced by another piece of furniture, interchangeably.

Structural system. The structural system is the “furniture kit” in itself. Each module associates three hierarchical groups of structural elements. This enhances the global performance of the house in terms of both vertical and horizontal loads, as well as carrying internal loads derived from uses of the furniture itself. The modules fixed onto a platform which features an adjustable support system.

House envelope. The house has two main layers: the furniture elements’ light wall, and the facade panel. For the wall, we used the following components (from the interior to the exterior): DM panel finished with Formica®, rock-wool insulation, OSB water-repellent panel, and reflective insulation. For the outside layer, we used compact panels by Formica®. Since there is an air gap inside, it acts as a semi-ventilated facade (any texture, colour or appearance).

We partly integrated solar thermal collectors to the south facade. They substitute the external layer of the wall (see Solar System).

Interior Comfort, HVAC and House Systems

Interior comfort. The conditioning and system design of

Solarkit aimed at meeting standards of comfort, within the competition range and the quality parameters established by the CTE (the Spanish building code). At the same time, it aimed at improving the general performance of a conventional house (in terms of ventilation, noise insulation, acoustic comfort, humidity, temperature, CO₂, illumination, etc.). Thus, the house includes active and passive climate strategies which meet standards of comfort while minimizing by far energy consumption, compared to actual Spanish regulations about air conditioning and energy demand.

The first step was to provide a good constructive design while maximizing insulation solutions (reasonably cost-effective vs. the climate) for windows, roof, floor and facade.

The passive system. Our passive strategies are inspired by traditional Mediterranean and North-African compact architecture. The house presents no external windows, but a number of small patios which bring in air and light. Patios can be arranged in two settings according to the annual climate conditions.

During the summer, glass-louvers at the top of the patios remain open, but canopy and lateral shadings are shut down, so to prevent direct radiations from coming inside. On the floor, plants refresh the air before it reaches the inside. Besides, two solar ventilation towers push air into the house, creating cross-ventilation flows.

During the winter, patios’ glass louvers and lateral windows are closed, while top and lateral shading elements are opened. This creates an air volume which works as a greenhouse. This way, the patios collect sun radiations in a very effective way: they maximise heat gains from the openings in the wintertime. In addition, the different spaces of the Solarkit house are located using the optimum orientations for our latitude: day areas to the west and night areas to the east.

HVAC systems. HVAC systems include a radiant-chilling ceiling for all the spaces, air extraction for the bathroom and the kitchen, and air plenum at the raised floor for the distribution of the air inlet.

The cooling and heating system consists of a radiant ceiling ("Climatización Tranquila" by Dynamobel©) which meets a good energy demand vs. desired temperature comfort ratio. The water that flows through the radiant ceiling is treated thermally with a high efficiency Daikin© air-water heat pump. During the winter, if the solar panels overproduce, excess energy can be used for the heating circuit. If the solar thermal panels do not produce enough energy, the production system is activated so to help the DHW demand. This mixed heating and cooling plus domestic hot water with solar heating panel contribution is the Altherma© system of Daikin©.

The entire control of the different systems of the house is based on several optimization algorithms of energetic resources. The use of mineral wool (MW), a material that has both thermal and acoustic insulation properties, simplifies the composition of the general envelope.

Natural and artificial lighting. We rigorously optimized the lighting in order to reach an adequate balance between the lighting level desired for each space, energy consumption and available solar radiations. For natural lighting, patios are located in the areas presenting the highest quantitative and qualitative lighting demands. Apart from its high efficiency characteristics, artificial lighting is smartly integrated in the furniture elements, where activities which are more demanding in terms of light intensity are likely to happen.

Water use. In order to reduce water consumption during the life-cycle of the house, we deployed several strategies such as air mixing saving devices in faucets, as well as the use of recycled rain water and grey water for watering and evapotranspiration in the tower and dry-construction systems.

Solar Systems

PV system. Instead of considering the house mainly as a stand of photovoltaic generators, Solarkit integrates a wide range of systems improving the performance of the generators:

- Efficient generation. The optimized design of the PV

generators matches energy consumption. New MPPT converters and multi string configuration improve PV energy conversion.

- Efficient distribution. New fully controlled internal energy distribution system (using new power control algorithms). Back-up super capacitors energy storage system to prevent consumption peaks. Full integration with energy grids with harmonics and reactive power control for power injection. Full controlled internal grid with active protections and power control.

- Efficient consumption. High performance lighting and climatic systems are controlled in order to meet environmental requirements. Fully sensorized house monitors the use of energy. New energy control algorithms prioritize passive lightning, cooling and heating.

Thermal solar systems. Our system design provides a right balance between energy production and demand, with a solar contribution over 60% of the monthly demand.

Vertical configuration maximises the architectural integration of the collectors because they have been placed in the exterior layer of the facade (as part of it); it helps to provide solar energy during the winter, when the demand is higher.

Solar thermal panels also help to heat the thermal inertia hot water tank, which supplies the DHW and heating energy demands of the house, combined with the action of an air-water heat pump.

Singular Systems

The operation of the solar ventilation towers is based on the principles of two traditional systems of bioclimatic architecture: the solar chimney (for extracting hot air from the interior when needed), and the traditional wind tower (for air intake and evaporative cooling).

The incorporation of PCM in the raised floor also allows the recovering of stored energy by forcing the airflow through that plenum.



Floor plan





Roof plan

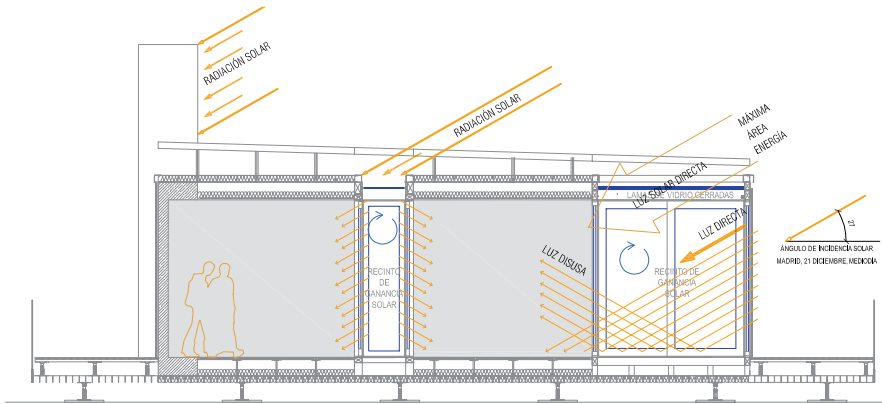

Natural lighting

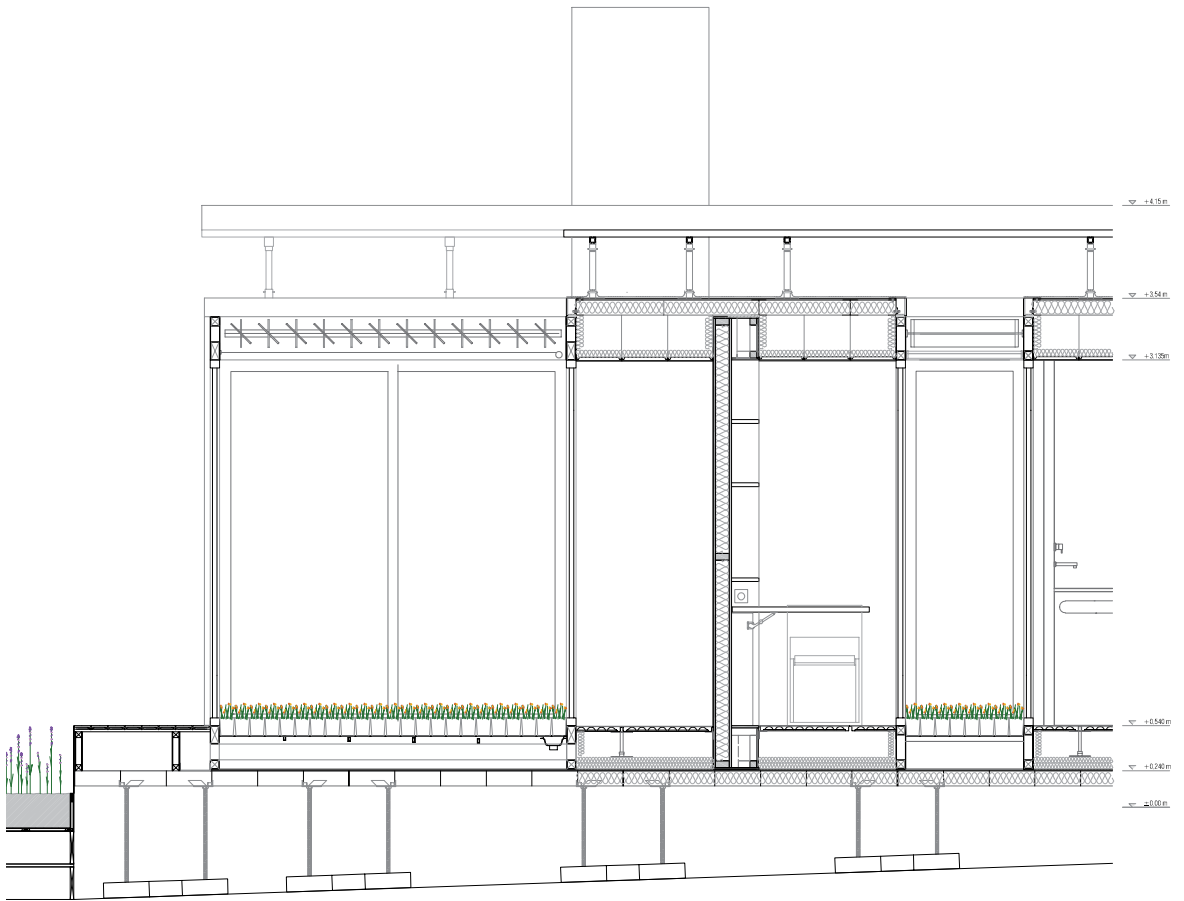

Detailed section

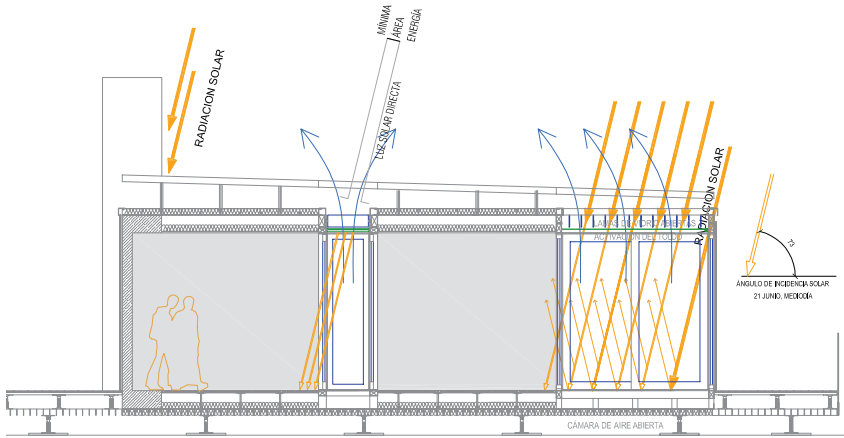

Natural lighting

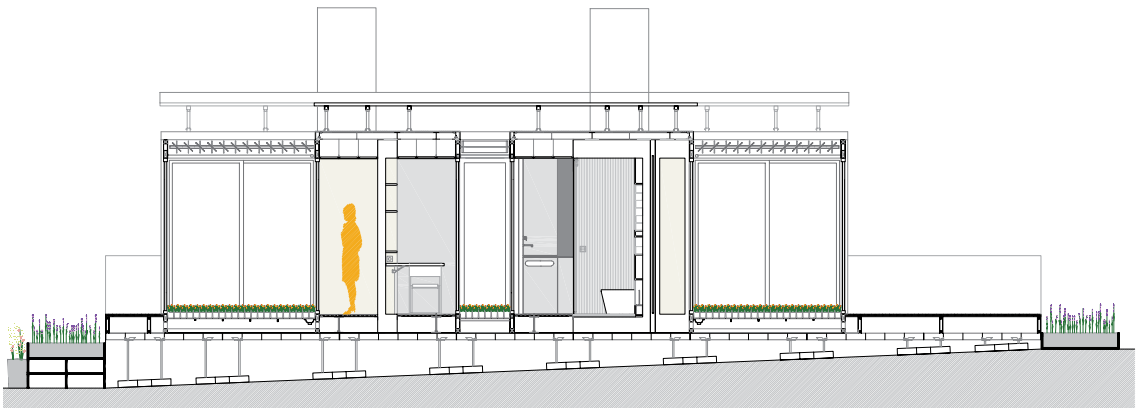

Section

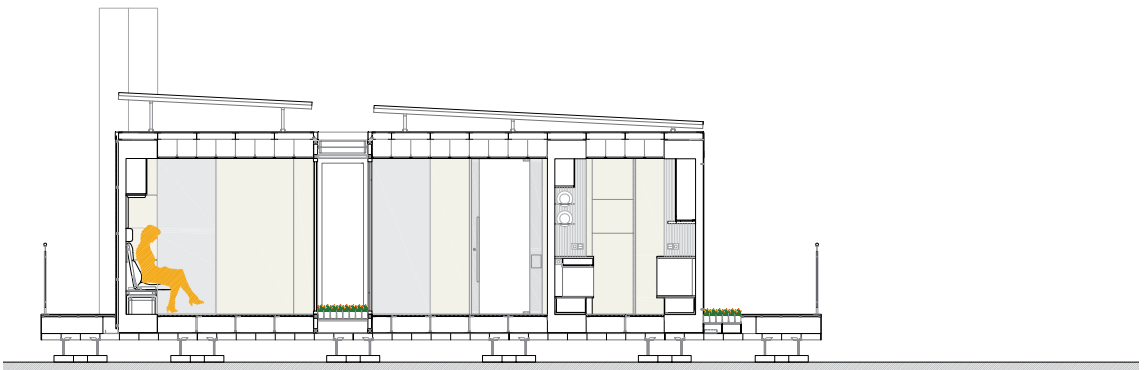

Section

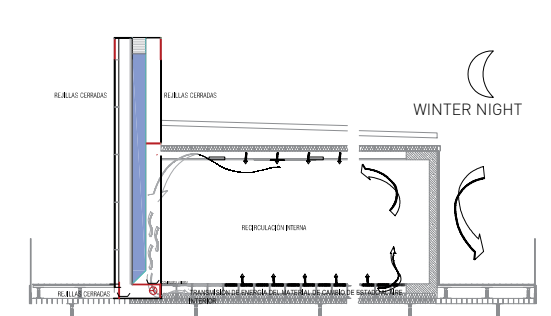
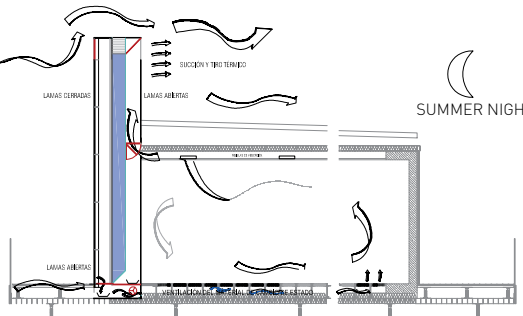
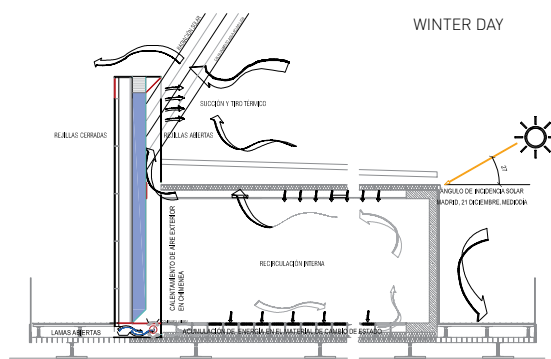
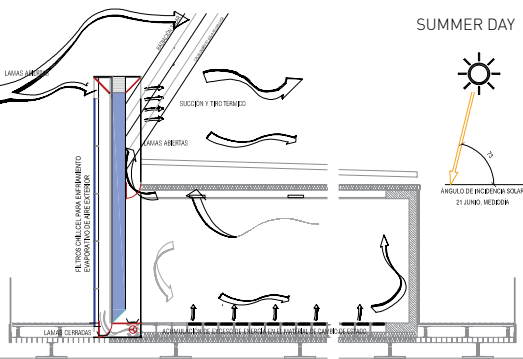
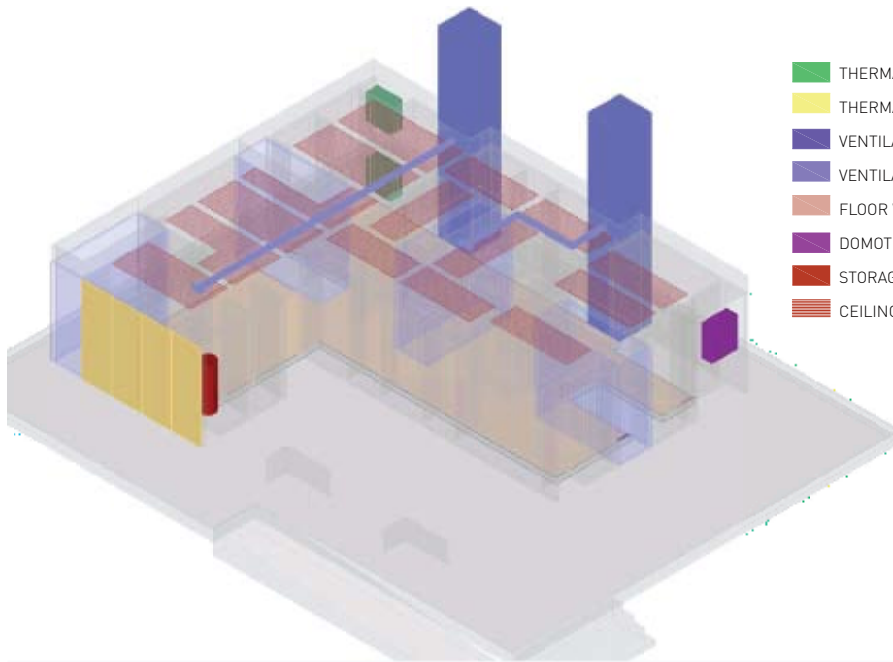

Passive strategies

TECHNICAL DATA OF THE HOUSE

Project name:

Solarkit

Construction area:

67,74 m² (useful area 55,98 m²)

Conditioned area:

51,71 m²

Conditioned Volume:

124,10 m³

ENERGY BALANCE

Estimated energy balance:

+8.278 kWh/a (surplus)

Estimated CO2 Emissions:

3.536 kgCO2 /a

Estimated energy production:

12.604 kWh/a (photovoltaics)

Photovoltaic system:

Installed PV power:

9,6 kWp

Types of PV Modules:

Two types of monocrystalline modules:

315Wp SunPower Corp (27 units)

225Wp SunPower Corp (5 units)

ENERGY CONSUMPTION

Estimated energy consumption Madrid:

4.326,4 kWh/a

Estimated electrical consumption:

73,5 kWh/m²a

Characterization of energy use:

Appliances 63%, Heating 12%, Ventilation 1%, Cooling 9%, Lighting 9%, Auxiliari DWH 6%.

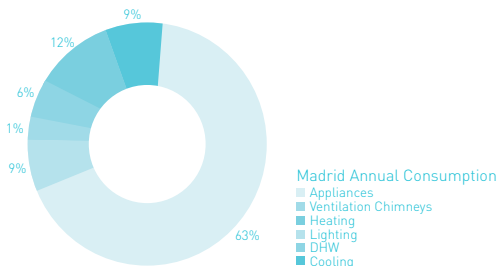

Information provided by the university

CONSTRUCTION ENVELOPE

Insulation types:

Types	Thickness
EPS. TECNOPOLEX - Blocks Type III	Roof e=100 mm
	Floor e=100 mm
MW. ISOVER - ECO-90	Roof e= 40 mm
	Walls & façade e= 80 mm
XPS. BASF - R00FIX	Floor e= 80 mm
Reflective. Optimer Systems Super Polymum HR	Façade e=4mm

Constructive Systems thermal transmittance:

Item	Thermal transmittance
Façade	0,35
Roof	0,18
Floor	0,18
Window	1,72

SPECIAL AND INNOVATIVE SYSTEMS

Constructive system:

"kit Furniture": easy (do-it-yourself), modular and adaptable construction system

Adjustable support system for platform level

Passive strategies:

Compact building, with a form factor reduced, with few holes to the exterior, focused on its interior patios.

Increase of the thermal inertia thanks to the integration of PCM in the floor of the house.

Optimization of the patio element, what enables its use as a greenhouse in winter and an open patio in summer. Location of the different spaces using the optimum orientations for our latitude: day areas to the west and night areas to the east.

Use of the vegetation as a passive conditioning system of the house. Natural lighting, controlled with patio furniture elements.

Systems to reduce water consumption:

Using air mixing saving devices in faucets.

Using recycled rain water and grey water for watering and evapotranspiration in the tower.

Ventilation systems:

Natural ventilation, controlled with solar chimney furniture elements.

Solar chimney pre-conditions (through evapotranspiration) the ventilation air, reducing the conditioning load necessary in summer.

A radiant conditioning system makes air impulse unnecessary

COSTS

Construction Cost: **250.000 €**

Industrialized Estimate Cost: **120.000 €**

LOW3

Universidad Politécnic de Catalunya Spain



Nº.13 / 667,58 points

Contest 1: Architecture: 120,00 points.

Contest 2: Engineering and Construction: 46,00 points.

Contest 3: Solar Systems and Hot Water: 65,63 points.

Contest 4: Electrical Energy Balance: 107,97 points.

Contest 5: Comfort Conditions: 80,93 points.

Contest 6: Appliances and Functioning: 66,66 points.

Contest 7: Communication and Social Awareness: 18,60 points.

Contest 8: Industrialization and Market Viability: 46,30 points.

Contest 9: Innovation: 34,50 points.

Contest 10: Sustainability: 85,00 points.

Bonus Points and Penalties: -4,00 points.

Introduction and Main Objectives of the Project

The LOW3 (low energy – low impact – low cost) is a prototype we, the UPC-Barcelona Tech, developed for the Solar Decathlon Europe 2010. It is a self-sufficient solar house based on three main principles: a *low energy* demand, a *low impact* on the environment, and a *low cost* architecture with a strong focus on the economy of means. LOW3 explores the thermal capacity of intermediate spaces in contributing to low energy architecture as well as it explores their spatial qualities, creating in-between spaces for innovative ways of living.

Our alternative housing concept is based on existing low-tech solutions: we aimed at creating an affordable but sophisticated solar house. The design process was driven by economic aspects from the beginning: we were searching for the maximum available volume at minimum cost, which led to the use of an off-the-shelf agricultural greenhouse, adapted to residential needs. Well integrated standard solar technologies allow energy self-sufficiency at a reasonable price.

Our holistic sustainability approach led to the implementation of a two step grey water recycling system, a dry toilet, and a vegetable garden that provides food self-sufficiency for the occupants.

Our “house-in-a-house” concept generates additional, “temporarily useful” floor spaces and volumes at a very low cost, as well as it improves the overall energy balance of the building.

Architectural Design

Today’s flexible and changing social conditions, new ways of living and working, as well as frequent changes in uses inspired our design. We explored an alternative, growing housing concept based on modularity in space, structure and installations; as well as the combination of interior highly insulated housing modules with a lightweight microclimatic building shell. Resulting intermediate spaces enrich the spatial concept of LOW3 and create, through their bioclimatic optimization, additional spaces and volumes available for the uses of the occupants.

The three main concepts of LOW3 are:

- Low energy: passive solar architecture and effective bioclimatic design minimize the energy demand of the LOW3 house.
- Low impact: the use of sustainable and reusable materials minimizes the environmental impact of the project, in terms of construction and duration of use. LOW3 aims at fulfilling the important objective of “closing” water and material life cycles.
- Low cost: low-cost and low-tech solutions, all together with dry construction methods, allow quick modular assembling. It converts a green house structure into an innovative solar housing concept.

Exterior design. LOW3 is a highly insulated, minimum housing unit of 42 m². The outer shell of the building is based on an industrialized greenhouse structure featuring a lightweight polycarbonate skin. Such a *microclimatic skin* modifies the thermal behavior of the

house. Openings for cross ventilation, shading devices, vegetation, an evaporative cooling system and integrated solar systems optimize the bioclimatic performances of LOW3.

The interior is actively conditioned through a radiant heating and cooling system, as well as a ventilation system with heat recovery. The intermediate space of LOW3 is designed to create comfort conditions exclusively through passive strategies.

On the north side, an independent row of installation boxes contains all the necessary equipment for active climate system, hot water supply, fresh water tanks and grey water recycling. Due to their accessibility, these installations can easily be modified or upgraded according to specific location and/or uses.

Interior design. The inner living modules of LOW3 form a minimum housing unit of 42 m², according to the basic requirement of the competition. Three living modules and one wet module containing the bathroom, the kitchen and all the main installations of the prototype are strategically located inside the greenhouse. The building shell generates a microclimate and supports solar hot water and electricity generation.

Small window openings and one main access door located on the north side contrast with the south facade, which is completely glazed.

The kitchen module adjoins an intermediate space, allowing the evacuation of internal thermal loads from cooking, and giving access to the wet module. This intermediate space is the core of the house: it is a shared infrastructure available for a variety of use.

Construction and Materials

Construction and industrialization systems. The microclimatic skin of LOW3 employs a standard industrialized greenhouse structure, based on galvanized steel profiles and polycarbonate panels as skin. Every structural element can be demounted and reused, or adapted over the life cycle of the house.

The living modules consist of micro laminated KERTO wood structures, in combination with lightweight Fiji wood beams and OSB board cladding. No mineral-based construction material is used for the inner housing unit. The modularity of the inner living modules, as well as the outer greenhouse structure (with a standard width of 2.5 m) convert the LOW3 concept into a modular growing housing system. It allows many possible configurations ranging from low cost, minimum housing to larger projects (co-housing, living and working spaces, etc.) which can be modified over the life cycle of the house.

House Envelope. The polycarbonate panels used for the outer building shell are specially treated for resistance against UV radiation. They are 12 mm thick, have four layers (three chambers) and a U-value of 2.2 W/m²K with a visual light transmission of 42% and a solar factor of 0.52 for white or "opale" modules. Their visual light transmission is of 72% and they have a solar factor of 0.77 for translucent or "crystal" modules. Special constructive solutions allow an elevated air-tightness of the building shell, in comparison with standard agricultural greenhouses.

The inner living modules are highly insulated with 160 mm of wood fiberboards (walls), cellulose panels (floor and roof) and a low-e double glazing (south facade), for an overall average U-value of about 0.43 W/m²K and high air-tightness.

The south facade of the inner living modules captures direct solar radiation in winter, whereas in summer, glazed areas of the inner modules are shaded by the geometry of the construction and additional shading devices.

Interior Comfort HVAC and House Systems

The intermediate spaces of LOW3 are thermally regulated through basic bioclimatic mechanisms (mainly adapted from the agricultural sector) like movable sun protections, evaporative cooling, cross ventilation via extensive openings and passive solar use. Their period of use is extended throughout the year without any kind of additional energetic or economic cost.

Depending on weather conditions – according to the activities users want to perform -, the intermediate spaces expand the space of the dwelling itself. The design and function of each facade or roof segment contribute to this objective.

The translucent collector south facade of the LOW3 prototype can open up and provide a porch for the house. Three out of four facade segments can be opened (by folding doors). Automated sunscreens protect the intermediate and interior spaces from excessive, direct solar radiation. The screens are made of resistant glass fiber, have a solar transmission value of 7%, and a visible light transmission value of 8% (see figure 11).

The facade segment corresponding to the wet module (contains the bath and the kitchen) integrates solar flat plate collector of 7,2 m². Due to their vertical integration and to their dimension, reaches 87,3% of domestic hot water demand.

The combination of opened or closed facade, as well as opened or closed sun screens, allows the greenhouse to act as either an open and ventilated shading roof, or as a closed buffer space which captures solar energy.

The north facade of LOW3 consists of a fix polycarbonate cladding, which is only interrupted by small window openings and the door. A 20 cm air gap between the inner living modules and the outer building shell allows all the main installations to be located between modules, making them easily accessible from the outside. No shading devices are needed. Thermal loads are evacuated through the roof opening.

The north part of the roof consists of a curved polycarbonate surface on metal substructure, with a standard green house opening mechanism. It is based on one central single phase motor and a horizontal mechanical axe which allows very slow lifting and closing of the whole roof segment. A movable outer shading device would be the most effective strategy to prevent overheating. Inside, easily accessible and movable solar protection has been planned. In combination with an opened roof and a cross ventilation, heat evacuation is considered sufficient, and easy maintenance is assured.

For technical reasons, shading devices couldn't be installed during the competition week in Madrid.

Temperature sensors, sensors for relative humidity, as well as a meteorological station inform a domotic system which automatically controls the shading devices as well as the roof opening or adiabatic cooling devices. It optimizes the microclimatic building shell, and contributes to the overall energy performance and comfort of the prototype.

We installed an evaporative cooling system in the intermediate space. In the context of Madrid's dry summers, the effectiveness of adiabatic cooling seemed especially relevant.

Solar Systems

LOW3 integrates a 4.2 kWp photovoltaic installation which annually produces 6.000 kWh of electricity - enough to make the house self-sufficient. According our initial low cost and low impact principles, we used a standard polycrystalline PV technology.

The PV modules are integrated into the roof structure. We used a galvanized steel framework which double skin allows the free circulation of the air (through a gap of 20 cm between the inner polycarbonate roof cladding and the PV array).

The photovoltaic installation is oriented towards the south, with an inclination of 19° - close to the optimum. A PV array shades the roof surface (on the south side) and avoids overheating of the intermediate space below. A natural stack effect induces high back ventilation: heat is carried away, and the temperature and efficiency of the modules are optimized.

PV modules are organized in strings of six, so they can easily be pre-assembled on the ground. They also enable an efficient roof installation, the electrical connection points (in the lower part of the roof) being accessible from the facade.



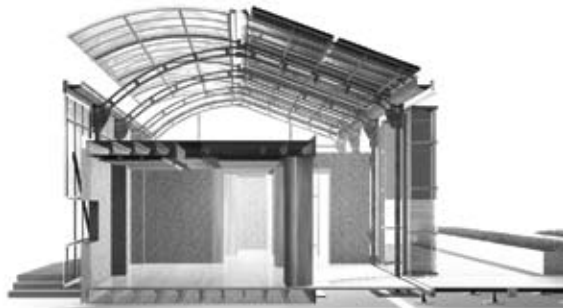
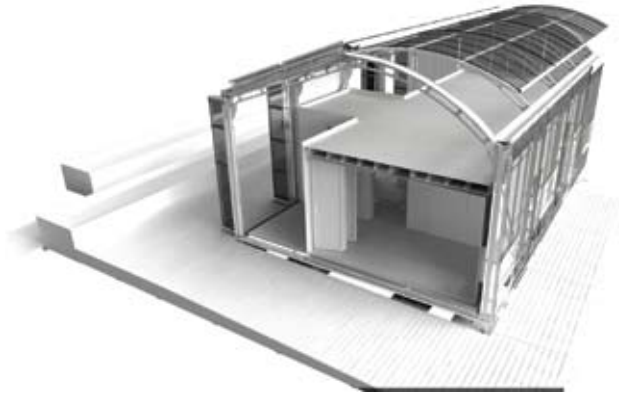

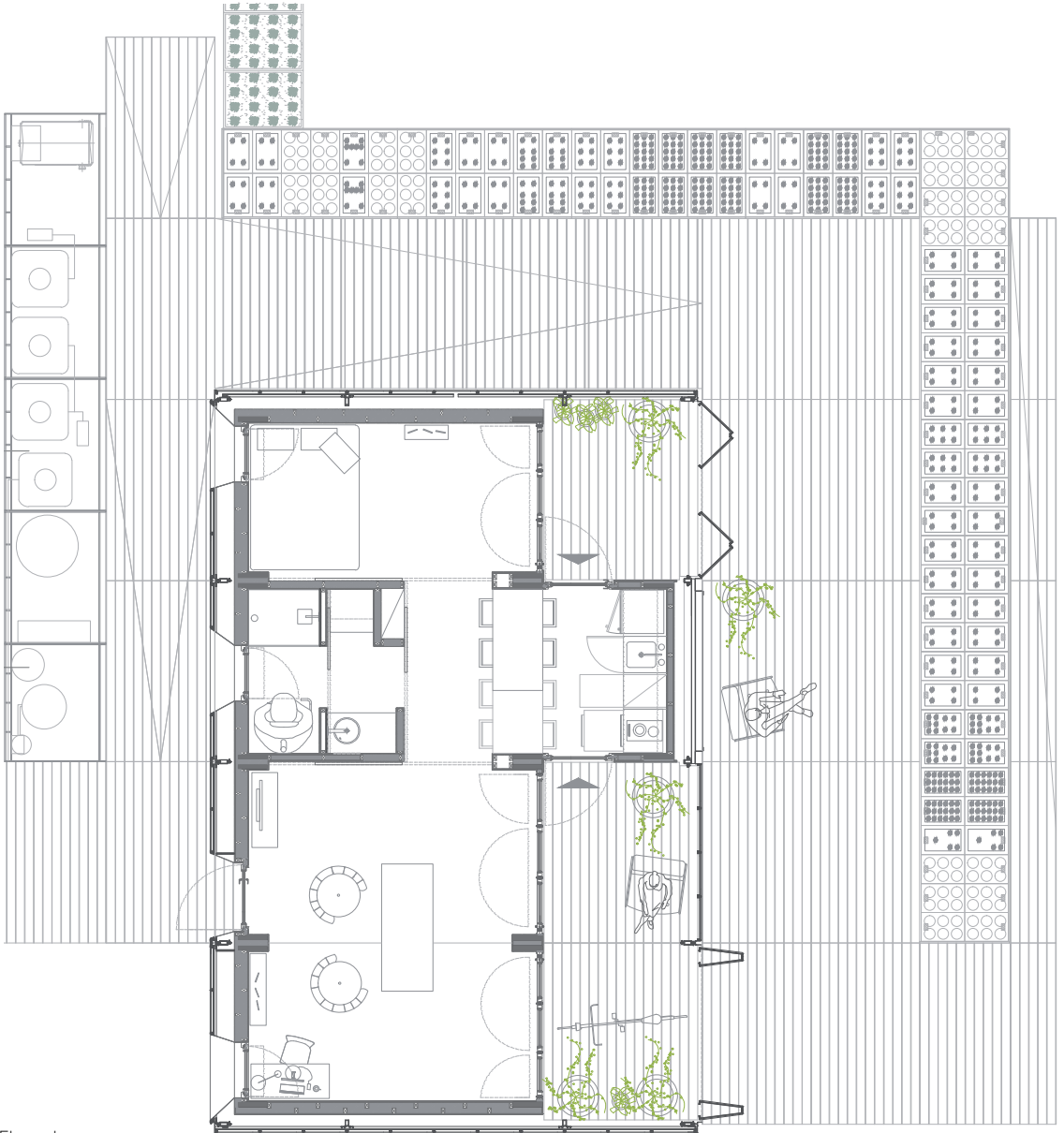

Floor plan

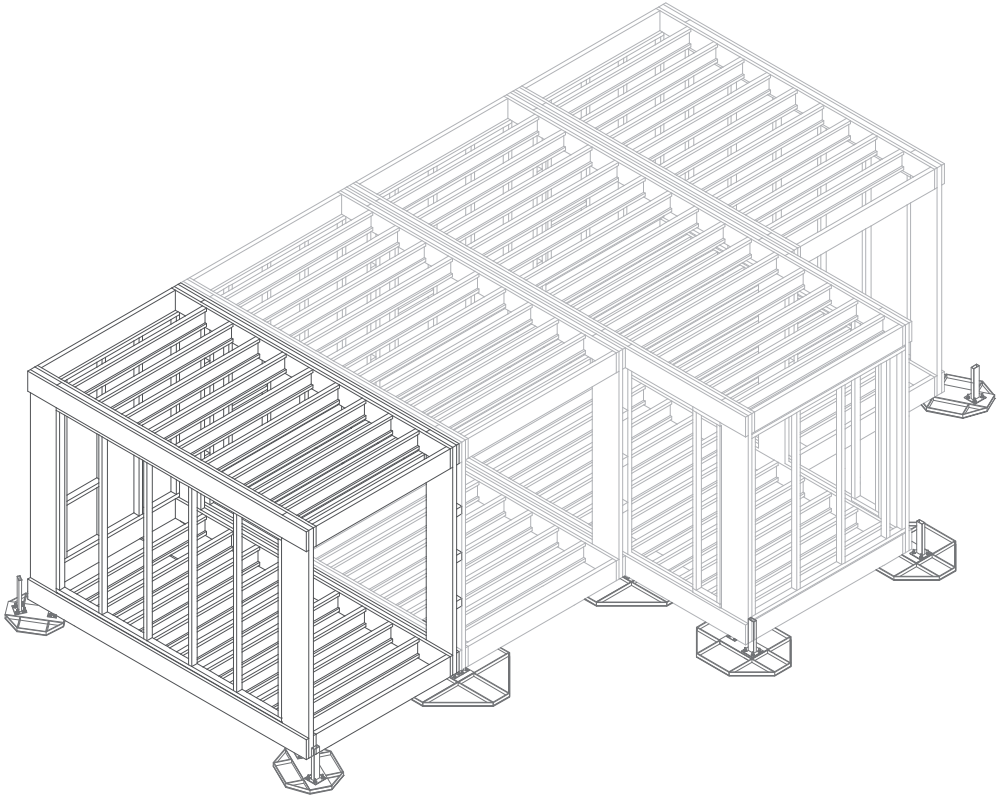

Modules Construction system

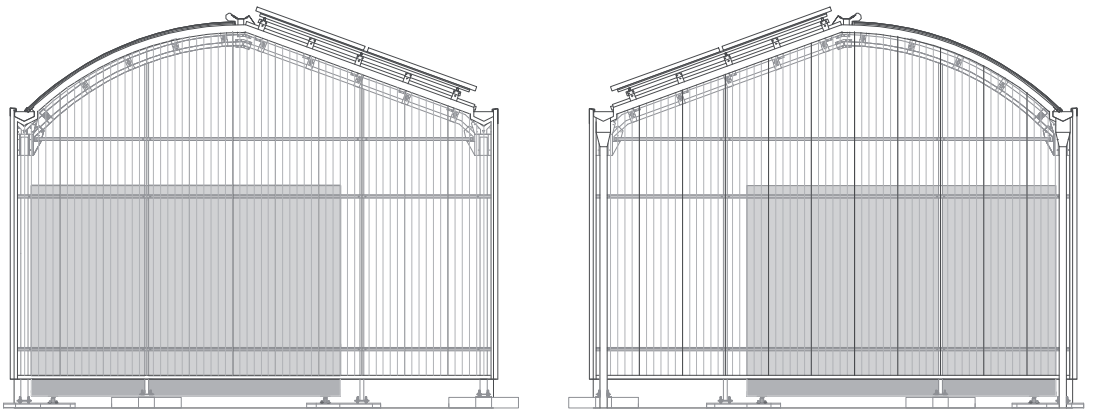

Elevations

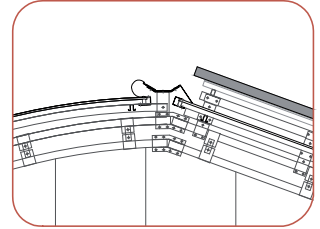
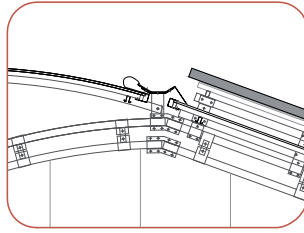
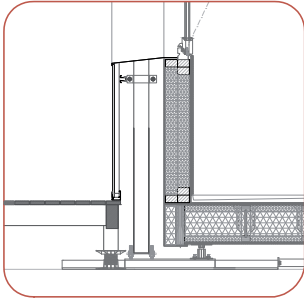

Construction details

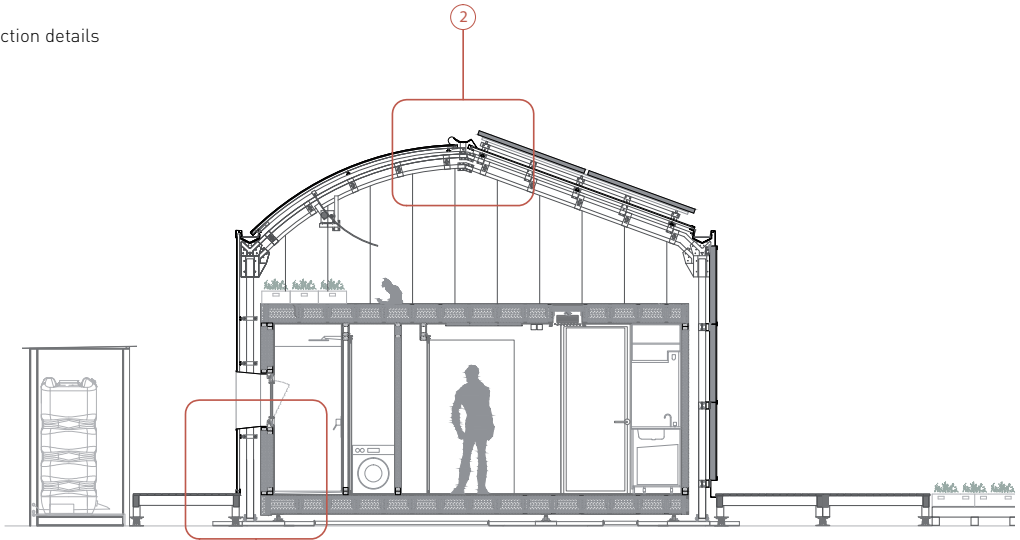

Section 1

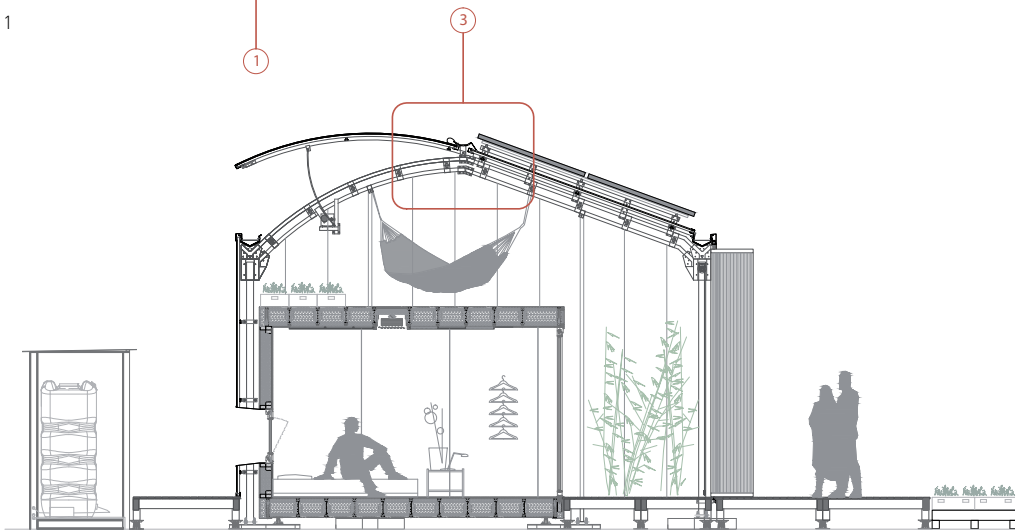

Section 2

Summer day

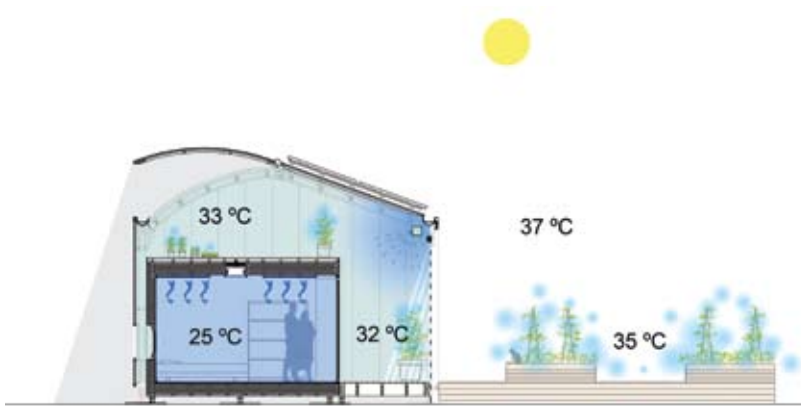

Summer night

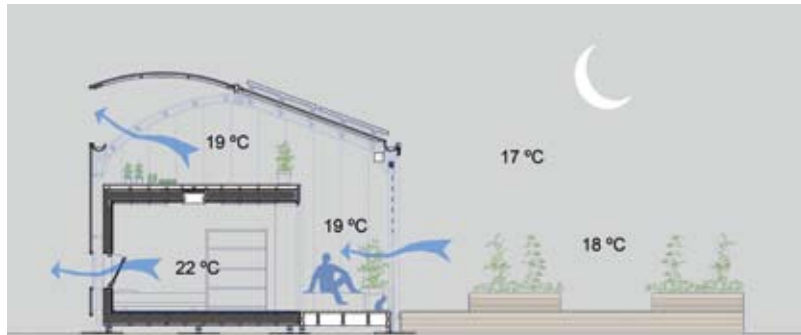

Winter day



Winter night

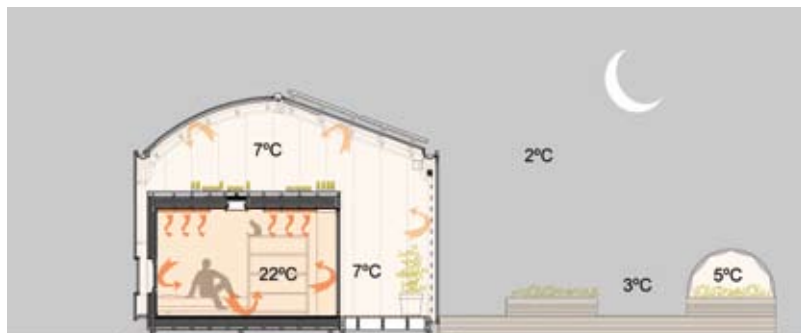

Bioclimatic Analysis

TECHNICAL DATA OF THE HOUSE

Project name:

LOW3

Construction area:

74 m²

Conditioned area:

42 m²

Conditioned Volume:

101 m³

ENERGY BALANCE

Estimated energy balance:

+120 kWh/a

Estimated CO₂ emissions:

No emissions during use due to energy self-sufficiency based on solar energy.

CO₂ emission related to grey energy of building materials and installations during lifecycle of 50 years: approx. 3,8 kg/m₂ a (20% of standard housing in Spain, solar systems not included)

Solar Energy systems avoid CO₂ emissions of about 100 Tn over lifespan which results in an overall positive CO₂ Balance over lifespan

Estimated energy production:

6.000 kWh (PV), 2.830 kWh (Thermal)

Photovoltaic system:

Installed PV power (kW):

4,2 kW

Types of PV Modules:

24 polycrystalline modules SCHOTT-POLY-175

ENERGY CONSUMPTION

Estimated energy consumption:

5.800 kWh/a

Estimated electrical consumption:

140 kWh/m²a

Characterization of energy use:

Appliances 2.550 kWh

Heating and Climatization 1.650 kWh

Ventilation 225 kWh

Lighting 850 kWh

Domotic system 180 kWh

Water cycle 425 kWh

Information provided by the university

CONSTRUCTION ENVELOPE

Insulation types (type and thickness):

Wood fibre board GUTEX 160 mm (facades)

Cellulose panels HOMATERM 240 mm (floor and roof) together with exterior building shell Polycarbonate AISLUX ARCOPLUS 6124 12 mm

Constructive Systems thermal transmittance:

Floor 0,15 W/m²K

Ceiling 0,15 W/m²K

Façade 0,24 W/m²K

Exterior building skin 2,2 W/m²K

SPECIAL AND INNOVATIVE SYSTEMS

Very low energy building system based on industrialized green house structure.

Microclimatic building skin with integrated solar technologies as ventilated shadow roof (summer) or greenhouse (winter)

Low energy heating and cooling system through radiant ceiling panels in combination with heating and cooling coils for faster response and dehumification and mechanical ventilation system with heat recovery. (NAC Comfort)

2-step grey water recycling system and rainwater storage for irrigation of a vegetable garden (self supply)

Dry toilet without use of chemicals or water.

COSTS

Construction Cost:

402.000 € (total project budget)

240.000 € (prototype construction cost, material and manpower)

Industrialized Estimate Cost:

163.000 €

URCOMANTE

Universidad de Valladolid, Spain



Nº.14 / 650,98 points

Contest 1: Architecture: 66,00 points.
Contest 2: Engineering and Construction: 56,00 points.
Contest 3: Solar Systems and Hot Water: 57,84 points.
Contest 4: Electrical Energy Balance: 106,91 points.
Contest 5: Comfort Conditions: 51,76 points.
Contest 6: Appliances and Functioning: 101,67 points.
Contest 7: Communication and Social Awareness: 40,00 points.
Contest 8: Industrialization and Market Viability: 45,00 points.
Contest 9: Innovation: 40,80 points.
Contest 10: Sustainability: 85,00 points.
Bonus Points and Penalties: 0,00 points.

Introduction and Main Objectives of the Project

We have defined a variety of profiles of individuals based on characteristics of their life-style, their space needs, and the interaction between spaces, qualities, relevance and meanings.

URban metropolitan
COsmopolitan
aMbitious individuals
dilettANTE
immigrANT

URCOMANTE: *the virtual and variable inhabitant is said to be one who combines or can combine the needs and peculiarities of the following tribes: urban, cosmopolitans, ambitious individuals, dilettantes and immigrants. Somebody that is aware of the environment and sustainability. Somebody that is contemporary, ecological and humane.*

The house is organized in three separate areas. The northern area is the most isolated; it is a thermal transition space of about 1.2m wide, where the mechanical rooms are located. The central space is a multifunctional room with bedroom and kitchen annexed. This central area receives thermal radiation loads in winter, and prevents the excess of heat in summer. The southern area is the porch entrance; it is a shaded, fresh area which acts as thermal transition space in summer, and allows sun radiations in winter.

Architectural Design

The envelope of the Urcomante house is conceived as a folded skin, so to create a unique object which integrates the necessary systems, and achieve comfort conditions. It consists of a set of layers who achieve different functions: thermal and acoustic protection, waterproofing and systems.

Exterior design. Our third skin collects solar radiation and transforms it into energy. The exterior layer of this "skin" performs collecting functions. There, PV and thermal systems are integrated in the facade, visually suggesting a continuous envelope.

When reaching the collecting systems of the southern area, the envelope loses its form and spreads out, taking the shape of scales. It creates an open space where PV panels filter direct solar radiation. The envelope re-appears on the northern side, where the technical rooms are located. They perform functions of energy transformation, home automation control, water storage, and the ventilation system of the house, among others.

As a final gesture, the skin, following its solar nature, opens to the sky, generating an opening for light that enriches the interior space.

Interior design. The modules of our prototype are designed to be functional spaces used by individuals for their own, private activities. These spaces correspond to the study-bedroom, the bathroom and the kitchen.

The three functional spaces define three parallelepipeds. Their interior walls can be moved and connected to the multifunctional space. The room can get more or less dynamic, depending on the spatio-temporal needs and uses of the inhabitants. This is spatial sustainability.

Spaces are designed in order to perform energy saving. The house is a square building of 43m², with an interior height that varies from 2.4m on the south facade, to 3.8m on the north skylight. The form factor is 0.3.

Construction and Materials

The main objectives of the construction and industrialization of the design was to develop an open system that allows industrialized compatibility or integration of different components. Our goal was to provide a model that integrates a construction system in which the user can define the project and make decisions.

- Level 1. Support.
- Level 2. Envelope.
- Level 3. Functional modules.
- Level 4. Technological applications.

We favored dry construction and easily executed constructive solutions. The material used for the structure and insulation is wood or by-products. Glass has been used in south, east and west facades.

The exterior of the functional modules assumes collecting properties, which are integrated among opaque glasses and photovoltaic panels, in the same way as in the envelope. Interior details create a continuous rhythm: functional modules appear as boxes showing a continuous finish in all their faces which contrasts with the envelope.

Structural design. The structural system consists of 'ribs' made of laminated wood which create a framework that defines the envelope and where the functional modules are anchored. Those modules have been conceived as interchangeable elements. The use of wood for these elements optimum: it has a good structural

performance and it meets criteria of a light, simple and sustainable construction. The use of laminated wood allows freedom of form. These elements have a good structural performance in all directions, because of the ways in which their layers are bonded together.

House envelope. The house has a laminated, solid timber structure that reduces thermal bridges. The structure entails several layers of insulation. In curved spaces, and in between the wooden framework, we used industrial wool, with a conductivity of 0.04 w/m²K, and recycled wood fibers insulation with a transmissivity of 0.038 w/m²K. The exterior skin is made of wooden-concrete panels, which allow a ventilated facade. Underneath, an aluminum-propylene layer with thermo-reflexive properties prevents heat collection by radiation.

The deck-photovoltaic area is 64.85 m².

Differences in interior height allows the optimization of both indoor and outdoor convection cycles. Indoors, we pump the air from the top, releasing it from the lower part of the house, close to the floor, allowing a proper air renewal. A skylight placed in the higher part of the roof allows cross-ventilation when forced ventilation does not present great advantages. In the exterior, there is a thermal draft below the photovoltaic panels. An air chamber of 30 cm allows a cold deck, cooling the PV panels, and improving their efficiency. This pre-heated air rises by convection, up to a heat-air solar panel which increases the temperature of the air. Pumped by a fan, this hot air is used to heat the house in the winter, and is released during the summer.

Interior Comfort HVAC and House Systems

Interior comfort. Systems are interrelated. They adapt to daily environmental conditions throughout the year, and are activated by a control unit. They act as storage systems and as phase change managers, in order to adjust the inertia of the house during intermediate times. These systems correspond to:

- Heating air panel
- The use of photovoltaic panels heating associated with forced cooling

- Heat recovery from a technical room for air renewal purposes
- HVAC: multiple systems combine thermal distribution box and air distribution
- Geothermal heat pump simulated using phase change materials
- Ceramic evaporative cooler (also known as "botijo")

Natural and artificial lighting. We optimized natural light. The house includes a system which makes the most out of natural light by "not turning on" the light if a sufficient exterior light level is detected. We also installed LED lighting with motion detectors.

Water use. The thermal uptake has been calculated to heat the tank in the south during spring and autumn, after what the water is pumped to the house through a heat pump. We decided to emulate the conditions of stability and thermal inertia of the earth by using a tank in which we added 360kg of phase change materials.

We opted for an evaporation cooling system to release heat. However, as this method uses a lot of water, we built a sewage plant to treat stored water during winter and spring. Our system can collect more than 27000 liters of rainwater per year. During the summer, it can be evaporated and thus extract heat from the hot heat pump. When the hot water from solar systems is not sufficient in order to heat the 200l solar tank, an auxiliary system of heat pumps takes it in turn.

Solar Systems

PV system. We maximized the photovoltaic solar collectors. They are combined to a battery system to fulfill electric needs at night and minimize the power consumption of the house.

The photovoltaic system (9kWp installed) consists of two fields: the main field has 28 panels fixed-tilt to 10° and of 195W each. The other field is located in slats on the porch. Photovoltaic panels have been installed on walls facing east and west. The heterogeneity of the fields, shading and low power are optimized by connecting a battery bank in order to ensure the autonomy of the

house. The batteries are sized to meet the needs of a whole day.

Thermal solar systems. The energy flow used to heat the ACS comes from the collection of vacuum tubes. When the DHW tank temperature reaches 60 degrees, energy is directed to the south tank, which produces geothermal heat during the winter.

Thermal air panels are used for the house heating which are, together with air heating and photovoltaic panels, the primary sources of heating.

The operation of the panel is very simple. It is similar to the one of domestic hot water: a fan moves the air, which then passes through the conduits formed by the absorber and reach contact with the heated air. Once the air has been heated, it enters the building and is heated through vents.

The system is controlled by a thermostat: it starts and stops automatically. The flow of incoming air is heated by passing between the house and the solar panels. This increases the efficiency of photovoltaic panels, and facilitates forced cooling. The estimated power associated with the thermal plate and the recovery of heat from the solar panels is about 4150W. The estimated optimization of photovoltaic electricity production is 5%.

Singular Systems

The ceramic evaporative cooling system we designed is called "botijo". A gram of liquid water in transition towards a gram of water steam absorbs 2.3 kJ of the environment. Consequently, if we want to release 5kW of heat in one hour, we need to release $5 \text{ kJ/s} \times 3600 \text{ s/hour} = 18000 \text{ kJ}$ in one hour for its evaporation.

$$1800(\text{kJ}) / 2.3(\text{kJ/g}) = 7826 \text{ g of water.}$$

We have estimated that the flow of air that needs to be removed is 5371'483 W. Estimating the mass flow rate of the air introduced to 0.2-0.4kg/s, and the weight of the air of the house to 150kg, in 375-750 seconds, a complete air renewal would take place (if efficiency of renewal was of 100 %).



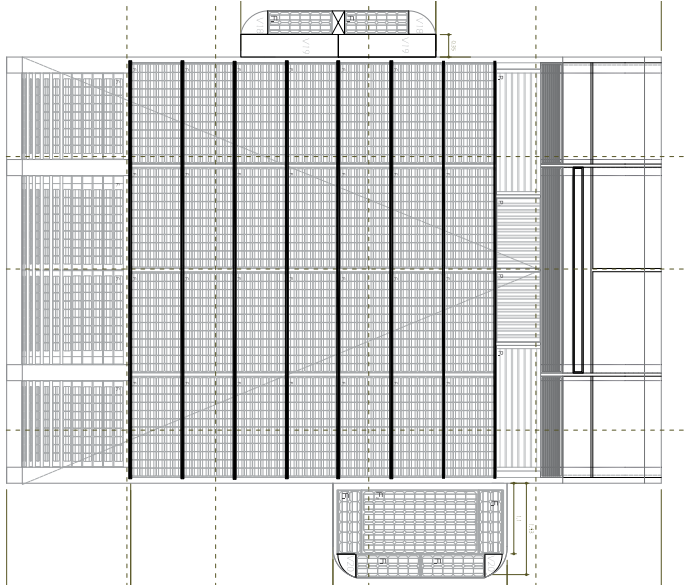

Roof floor plan

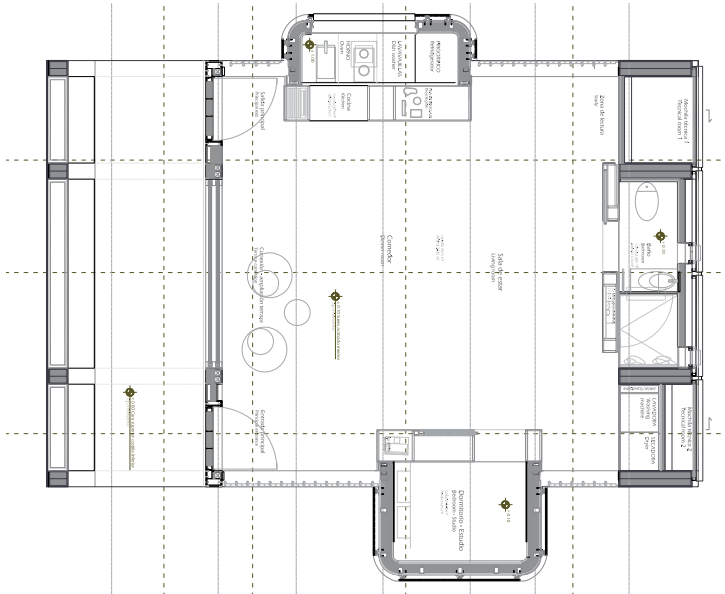

Floor plan

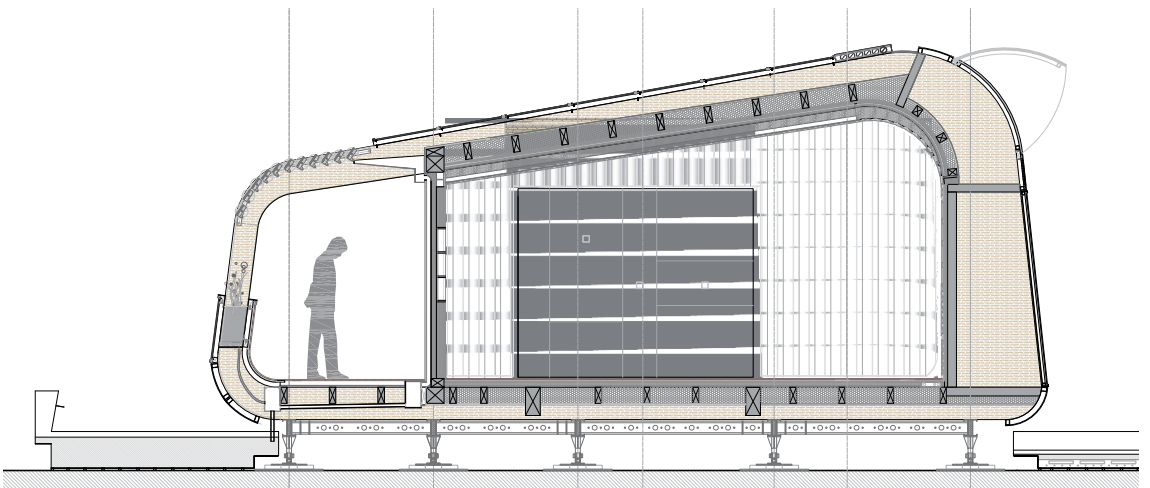
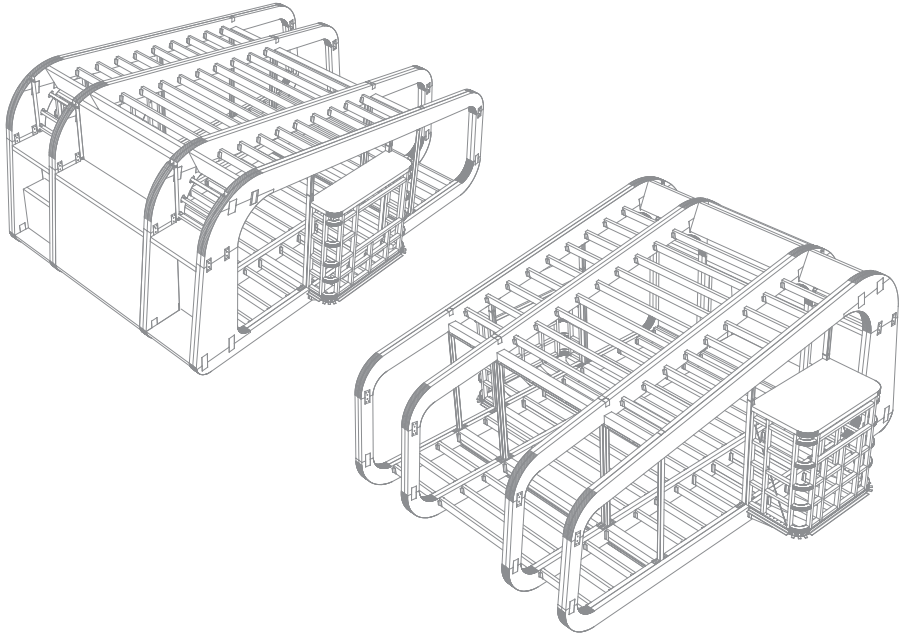

Longitudinal section

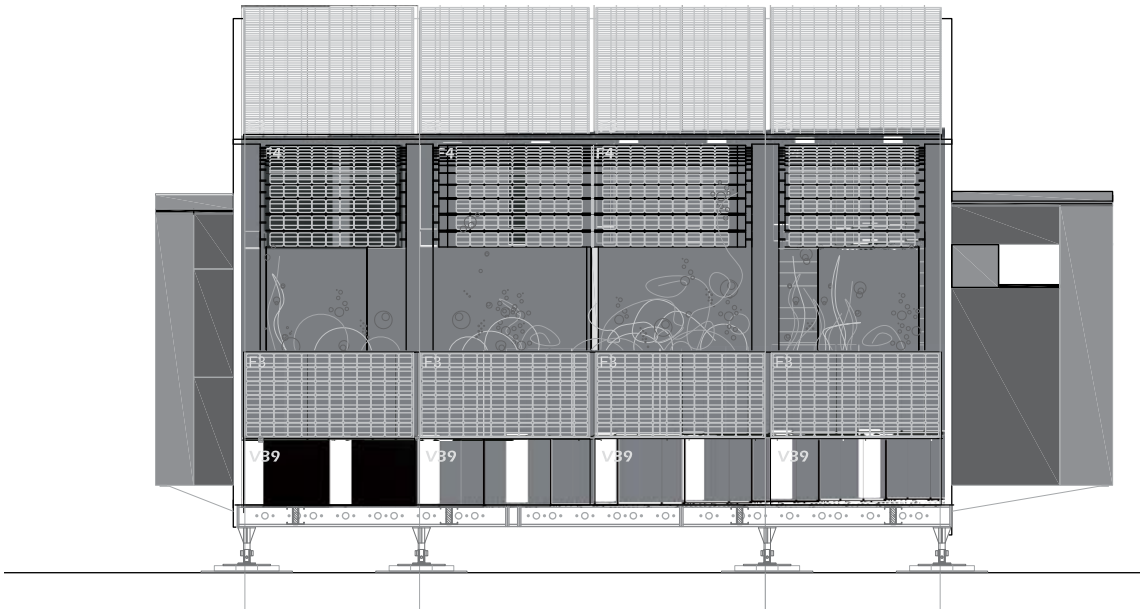

South elevation

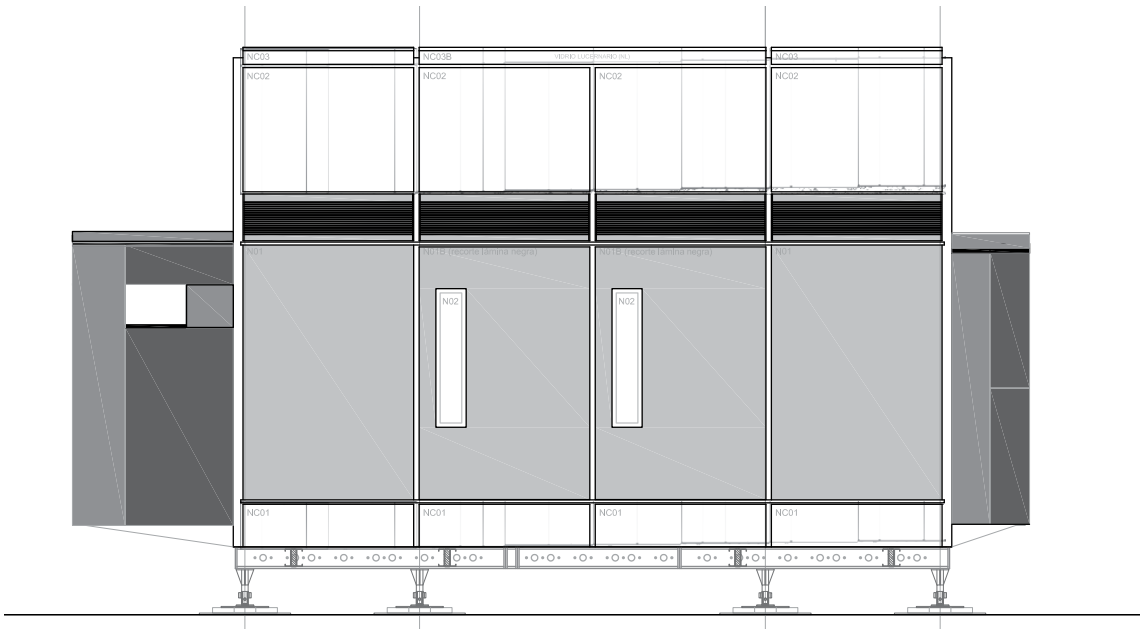

North elevation



Cross section box



Cross section bathroom

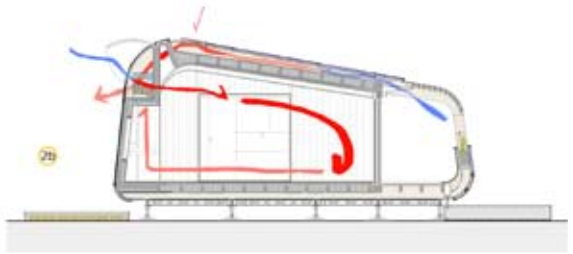
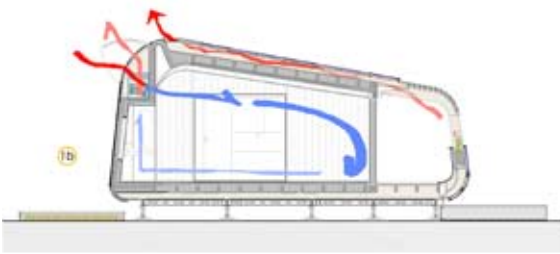
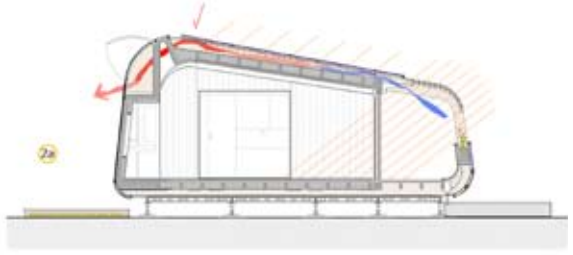
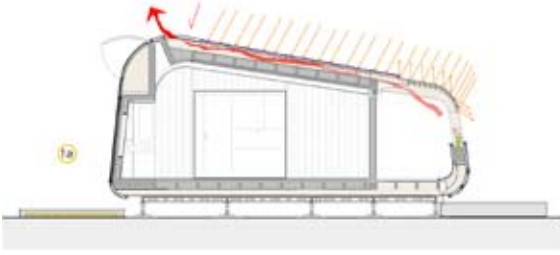

Summer analysis

Winter analysis

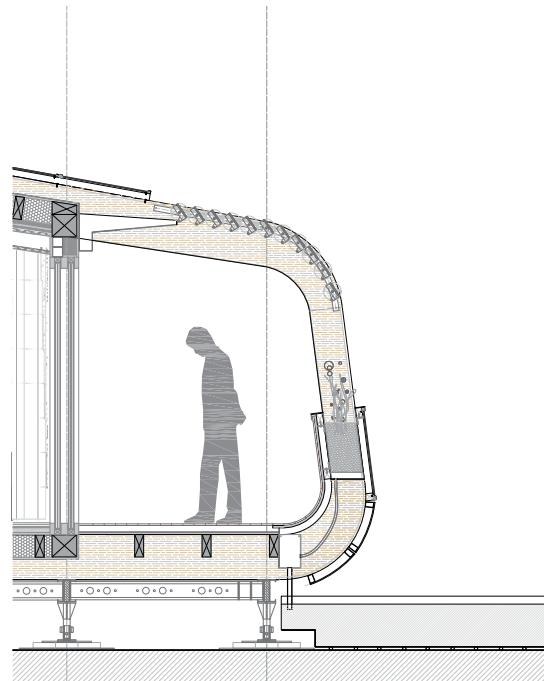
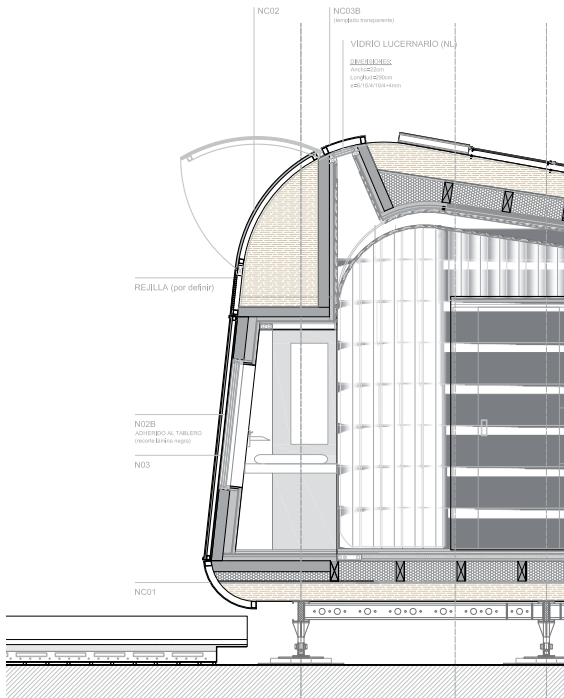

Longitudinal section

TECHNICAL DATA OF THE HOUSE

Project name:
Urcomante

Construction area:
57,52 m²

Conditioned area:
46,36 m²

Conditioned Volume:
188,66 m³

ENERGY BALANCE

Estimated energy balance:
+5.520 kWh/a

Estimated CO₂ emissions:
4.074 kg/a

Estimated energy production:
10.446 kWh/a

Photovoltaic system:
Total installed PV power:

9 kW peak

Types of PV Modules:

**There are two different suppliers for the PV panels:
Yohkon and Centrosolar**

ENERGY CONSUMPTION

Estimated energy consumption:
4.984 kWh/a

Estimated electrical consumption:
106,47 kWh/m²a

Characterization of energy use: *

Category	Value	Percentage
Space conditioning	2.455	49,26 %
Appliances	1.595	32,00 %
Lighting	187	3,74 %
Pumps	249	5,00 %
Top up water heating	498	10,00 %
	4.984	100,00 %

* SDE estimation
Information provided by the university

CONSTRUCTION ENVELOPE

Insulation types (type and thickness):
Woolbased fiber BIOKLIMA NATURE

Thermal Conductivity:
0,040 W/m.°K
Woolbased fiber THERMO BIOKLIMA NATURE

Thermal Conductivity:
0,040 W/m.°K
**Acoustic woolbased fiber panel IZOPANEL ACÚSTICO
BIOKLIMA NATURE**

Thermal Conductivity:
0,048 W/m.°K

Constructive Systems thermal transmittance:

Constructive element	Thermal transmittance
Opaque wall	0,25 W/m ² K
Floor	0,17 W/m ² K
Roof	0,18 W/m ² K
Windows	0,69 W/m ² K

SPECIAL AND INNOVATIVE SYSTEMS

The approach of the sources and the sinks.

Sources: Sun, Pools

Heat sinks: Domestic appliances, Climatization Devices, Faucets of warm water.

Obtaining of energy in the form of heat:

Direct Gains: Warm air panels,.Evacuated Tubes. Pools.

Indirect Gains: Recovery of heat from the electrical room, Heat recovery from conditioned air, Recovery photovoltaic panels.

COSTS

Construction Cost:
170.000 €

Industrialized Estimate Cost:
120.000 €

Nottingham H.O.U.S.E.

University of Nottingham, United Kingdom



Nº.15 / 643,18 points

Contest 1: Architecture: 72,00 points.

Contest 2: Engineering and Construction: 60,00 points.

Contest 3: Solar Systems and Hot Water: 36,00 points.

Contest 4: Electrical Energy Balance: 106,88 points.

Contest 5: Comfort Conditions: 65,90 points.

Contest 6: Appliances and Functioning: 61,09 points.

Contest 7: Communication and Social Awareness: 40,00 points.

Contest 8: Industrialization and Market Viability: 51,30 points.

Contest 9: Innovation: 36,50 points.

Contest 10: Sustainability: 115,00 points.

Bonus Points and Penalties: -1,50 points.

Introduction and Main Objectives of the Project

The key to understanding the final design of the Nottingham HOUSE is in understanding the context of low energy housing in the UK. For a very long time there has been a fascination with "eco houses", one off futuristic, low-energy houses designed as research projects; they often capture the media's attention for their gadgets and high-tech solutions, but rarely provide a realistic proposal to low-energy housing.

In recent years the University of Nottingham has taken great steps forward to provide solutions to these problems, developing a number of realistic proposals for low-energy housing on their Creative Energy Homes site on the university campus. The Nottingham entry to the Solar Decathlon was to be the most far reaching brief to date, targeting both PassivHaus standard and the British Code for Sustainable Homes level six rating (Zero Carbon).

That brief, along with the Solar Decathlon objectives, was given to students in the Zero Carbon Architectural Research Studio; they then designed a number of SDE prototypes as part of a pattern-book of houses to use in a sustainable master plan. From all of the teams, one design was selected to be taken forward. The winning design was one that took the University's brief a little further, taking the Solar Decathlon objectives and also imposing a realistic scenario upon it. Too often, the Solar Decathlon houses were examples of the "eco house", and so this design was to be a family house, two stories high, and able to be terraced to achieve sustainable

urban densities and better communities. The resulting house is a product of all of these briefs, and so while it may not look futuristic, full of gadgets, or even cutting edge, it is in fact a real-life solution to low-cost, zero-carbon housing in the UK and Europe

Architectural Design

As a solution to the many objectives, it was decided to work with an L shaped plan, which would create a private courtyard within the footprint and be joined to other houses on two of its sides. This design decision meant that to achieve the space requirements within the house, a two storey house was needed. The use of two storeys also meant that we could free up enough of the architectural footprint to provide a courtyard garden. The courtyard forms an integral part of the house design, as it provides a focus for the public areas of the house. It provides privacy, a shaded space in summer as well as providing enough space for the family to grow its own food (a large part of most family's energy footprint).

One of the ambitions of the design was to create a family house which was acoustically and visually permeable in its public areas to encourage and aid family life; circulation areas were made into interesting and useful spaces. It also needed to be space efficient given the height and area constraints of the SDE brief.

Part of this space strategy was making links across both stories, creating an open plan ground floor with some double height spaces and with private rooms on the second floor. This was tied into the environmental

strategy which uses the void above the dining area to deliver cooled air to the public areas below. This void then provides a visual and acoustic link between the private and public areas of the house and is reinforced by the application of colour in a vertical band of acoustic absorption panels to visually link the spaces.

The Nottingham H.O.U.S.E. is unusual in that part of its architectural footprint has been given over to a semi-conditioned south facing courtyard, which can either be shared with a neighbour's courtyard or enclosed by the next house. The idea behind this courtyard was to tackle wider issues of sustainability and to make the house more attractive to the wider public. Through the use of small managed planting boxes, the residents can grow staple crops, reducing their shopping bill, and their carbon footprint, as well as helping educate the family on the concept of in-season consumption.

Construction and Materials

The method of prefabrication was considered very early on in the design process, and where possible, the modular and structural approaches have been expressed as part of the internal strategy. This early decision meant that the method of construction and the architectural expression are inextricably linked.

A modular panel design meant that the house is essentially split into eight volumes, and so these joints can be seen throughout the house, expressing the method of construction which provides a sustainable story about efficient pre-fabrication. The method also provides a solution that can be mostly fabricated by student workers off-site, showing both the ease of the construction, but also the nature of the project as an educational tool. The nature of the construction means that the house can be entirely pre-fabricated and erected very quickly once on-site, but by using a panelised construction we also allow an option of a more traditional site based approach.

Timber frame panels provide a modern version of a traditional technology, and take advantage of timber as a form of carbon sequestration. These elements

also ensure that we achieve a thermal bridge free construction, which is needed to achieve a PassivHaus rating.

The timber cassettes that form the walls, ceilings and floors also contain the primary layer of insulation. Timber I sections ensure there is little thermal bridging, and to ensure a thermal bridge free construction a final layer of 50mm insulation was fixed to the external face of the volumes. Inside, a vapour and air-tightness membrane ensures PassivHaus levels of air-leakage, and a high density board which has a high recycled content provided most of the thermal mass in the house. This build up achieves 0.1W/mk in the walls, and 0.17 in floor and roof (this was down to height restrictions and it will be reduced to 0.1 in its final state).

Windows used were softwood framed, aluminium covered triple glazed windows, providing a U value of 0,5 W/m².K with a transmission of 69%. The transmission was maximised on all windows to enable solar gains, with a woven metal screen on the south facade, and a canopy over the courtyard preventing solar gains during the summer months.

Where possible, the design utilises materials and products that are realistic for a family house of this kind, but at the same time selected sustainable and recycled materials throughout.

Interior Comfort, HVAC and House Systems

The HOUSE has been designed with a number of systems that meet the needs of the occupants in an energy efficient manner. These have been developed in conjunction with the passive strategies employed in the design of the building envelope. This provides high resistance to the transmission of heat, airtight construction to minimise uncontrolled heat flow due to infiltration, appropriate levels of day-lighting to minimise reliance on artificial lighting and complementary solar protection strategies to control undesirable solar gains.

The HOUSE is designed for three distinct modes of operation to control internal comfort conditions:

heating, cooling and free running. The heating mode of operation makes use of a mechanical ventilation and heat recovery (MVHR) unit to maintain air quality within the HOUSE. This delivers fresh air to the two bedrooms and the living room and extracts stale air from the bathroom, toilet and kitchen. The heat exchanger helps to reduce heat loss from the exhaust air. The HOUSE is designed to benefit from passive solar gains, occupant gains and equipment gains which provide a large part of the heating demand. The remainder is provided by a heat exchanger positioned after the MVHR in the supply duct and connected to an air source heat pump. This allows for rapid heating of the building or maintaining comfort temperatures when low occupancy means that fresh air demand is reduced.

The HOUSE utilises passive evaporative draught cooling to maintain comfort temperatures during the cooling season. Nozzles positioned at the top of the double height space generate a micro spray of water that evaporates in warm external air drawn through the roof light. Evaporation of the water cools the air generating a plume that drops into the work station and then divides, part flowing through the living room and exiting via a window on the south wall. The remainder flows through the kitchen, absorbing heat from any appliances that are operating and exiting via a window in the north wall. Operation of the system responds to measurements of external and internal temperature and humidity via a control system that accepts input from the occupants to increase or reduce the rate of cooling. This is achieved by varying the number of nozzles in operation and the degree of window opening. The system requires energy to drive small air compressors, to run an ultraviolet water treatment cell and to operate the window controls. Beyond this, it is entirely passive in operation.

To meet Code for Sustainable Homes level 6 the house needs to meet a water usage of 60 litres/person/day. This was achieved through rainwater harvesting, grey water recycling and low water usage appliances and fixtures.

The house is primarily lit by natural light. Large windows and the courtyard ensure that each room has

access to views and natural light. The void ensures light at the deepest part of the plan. When natural light is not sufficient LED lights provide low-energy light to the rooms.

Solar System

The approach taken by the team to the design of the solar systems for the Nottingham HOUSE closely follows the overriding ethos for the project as a whole. The PV and solar thermal systems are designed to provide just enough energy for the family house throughout the year. This is done through a new generation of thin film panels which are now both efficient and low cost. We saw this as the most realistic and sustainable option, and while we were certain it would lose us points in the competition, we saw it as the right thing to do for the project.

The house should be judged not as a pavilion, but as a genuine attempt to develop a new solar house for public use. While at first glance, the house may not seem like a solar house, it is in fact almost entirely based around using solar energy to provide a zero or even negative carbon solution, using the idea of a family house to make the sustainable concepts more viable for mass market.

Though it may not shout about it, the Nottingham H.O.U.S.E. demonstrates to the general public a Home Optimising the Use of Solar Energy.



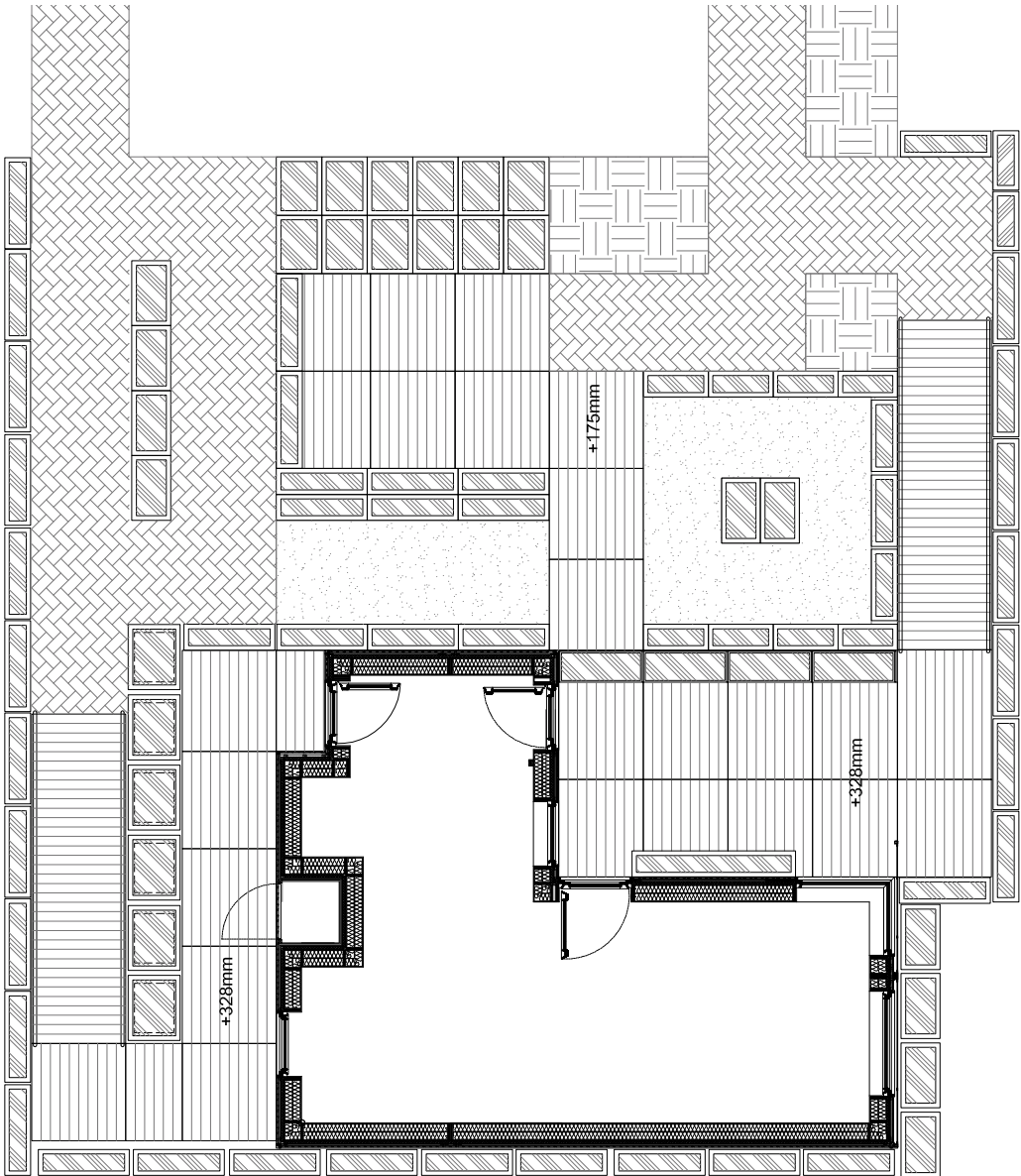

Floor plan

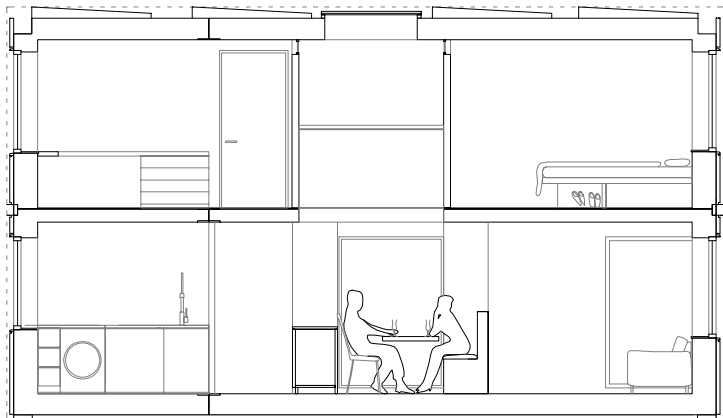

Section

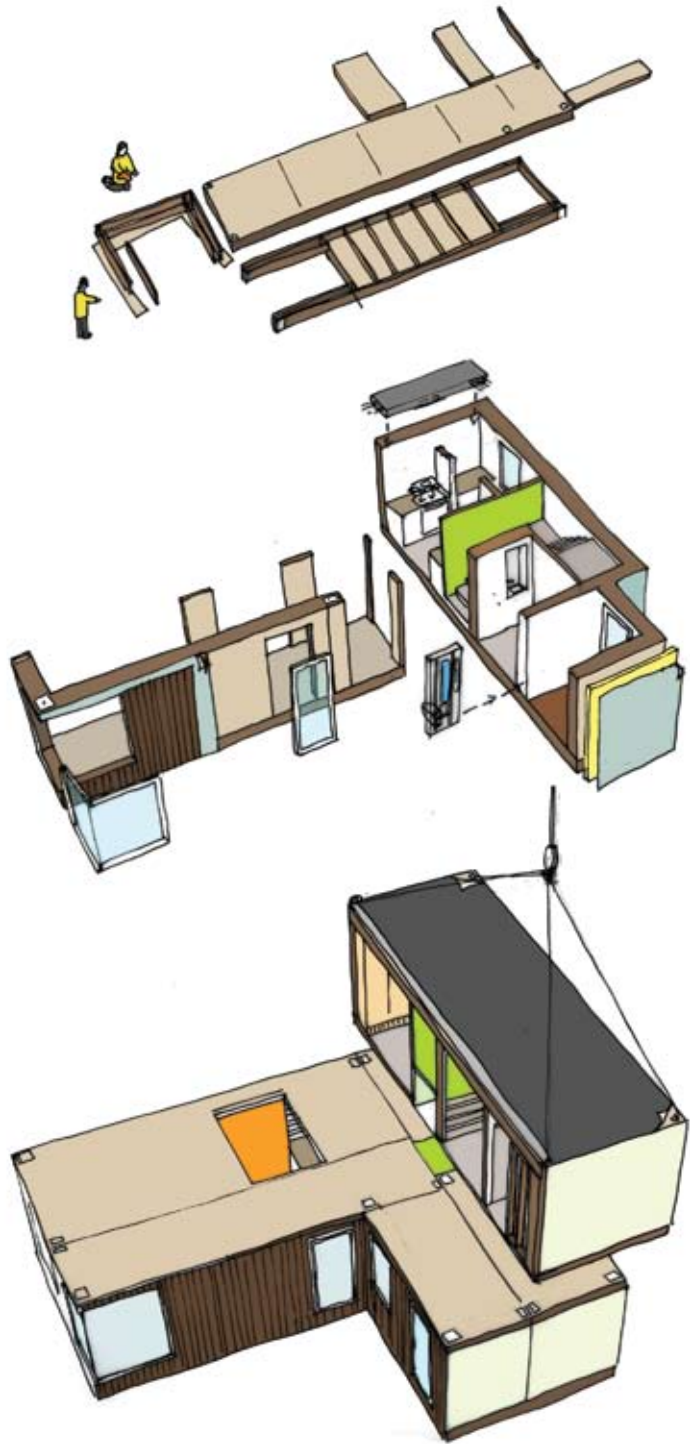

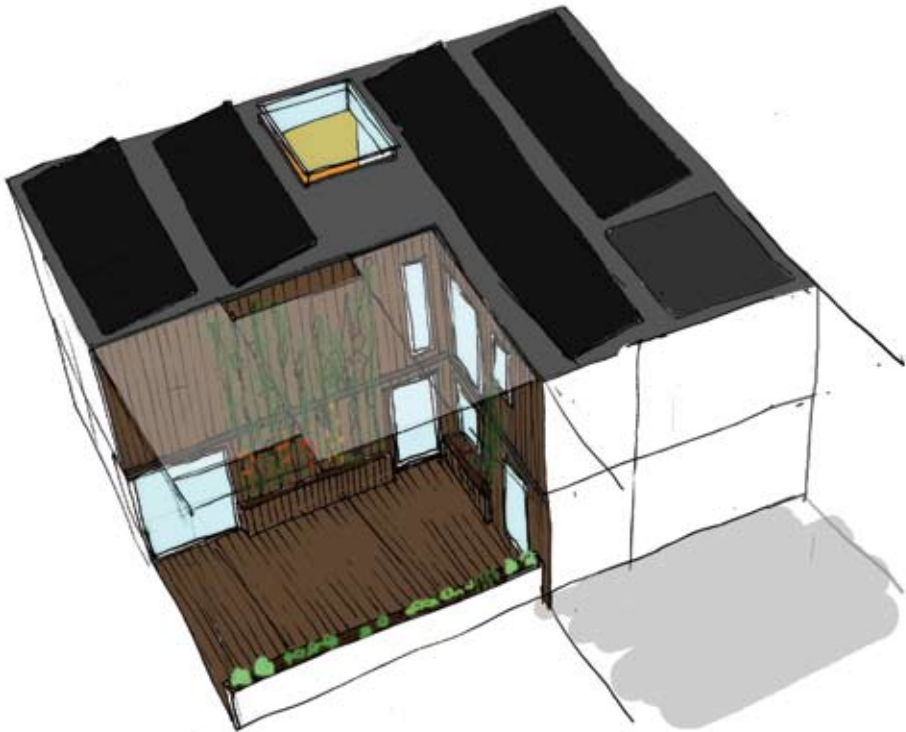
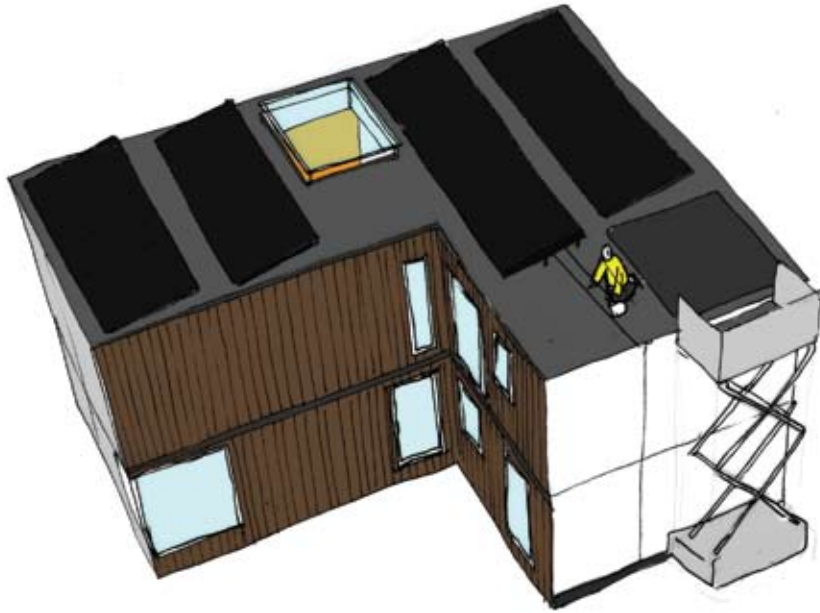

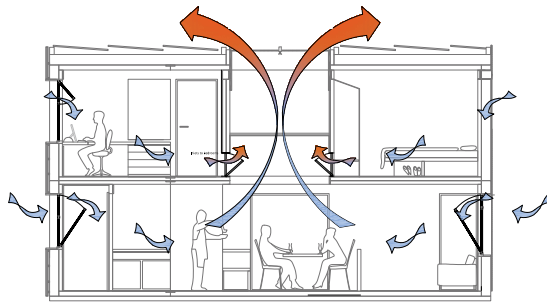
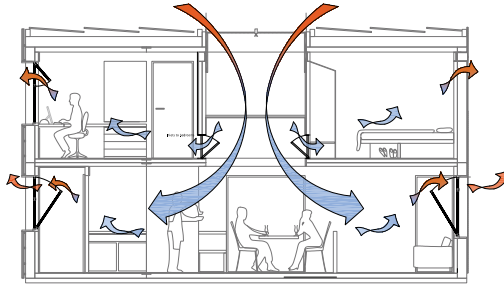

Bioclimatic Strategies

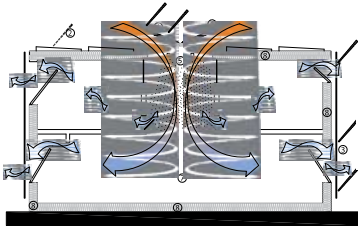

Summer day

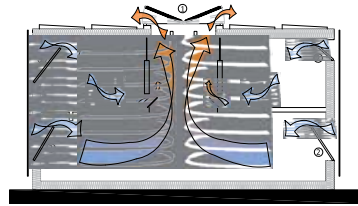

Summer night

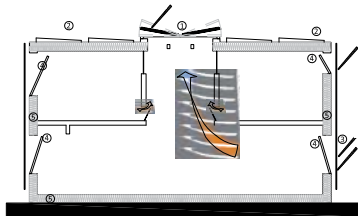

Spring day

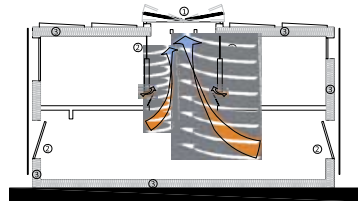

Spring night

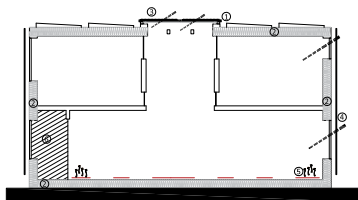

Winter day

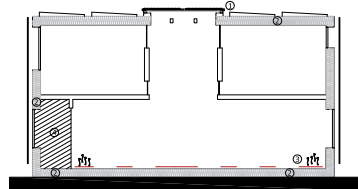

Winter night

TECHNICAL DATA OF THE HOUSE

Project name:
Nottingham H.O.U.S.E.

Construction area:
72m² site area
55m² building footprint

Conditioned area:
39m² ground floor
33m² first floor
72m² total

Conditioned Volume:
324 m³

ENERGY BALANCE

Estimated energy balance:
+23 kWh/a

Estimated CO₂ emissions:
1.603 kg/a

Estimated energy production:
4.032 kWh/a

Photovoltaic system:
Total installed PV power:
2.750 kW
Types of PV Modules:
24 m² polycrystalline PV array built using 24 Avancis Powermax modules located in a horizontal plane

ENERGY CONSUMPTION

Estimated energy consumption:
4.009 kWh/a

Estimated electrical consumption:
55,68 kWh/m²a

Characterization of energy use (KWh/a):

Space conditioning	1.626	40,56 %
Appliances	1.732	43,20 %
Lighting	150	3,74 %
Pumps	180	4,49 %
Top up water heating	321	8,01 %
Total	4.009	100,00 %

CONSTRUCTION ENVELOPE

Insulation types (type and thickness):
Inner layer: 245mm Isover Multimax 30 glass wool insulation
Outer layer: 50mm Isover RKL-Façade
Outer roof layer: 50mm Isover Roofline P35 Insulation

Constructive Systems thermal transmittance:
Wall 0,1 W/m²K
Floor 0,1 W/m²K
Roof 0,13 W/m²K
Glazing 0,5 W/m²K

SPECIAL AND INNOVATIVE SYSTEMS

Passive draught evaporative cooling systems (PDEC)
Mechanical ventilation and heat recovery (MVHR) and air source heat pump
Passive solar gains (explained in text)

COSTS

Construction Cost:
144,000 € Materials Appliances and Furniture
156,000 € Set-up and logistics

Industrialized Estimate Cost:
Unknown. Would be significantly lower as construction costs include travel and accommodation to Madrid for student and staff team, as well as the test-run build at Ecobuild in London.

SUNFLOWER

Tianjin University, China

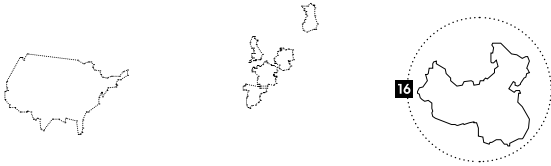

Nº.16 / 584,79 points

Contest 1: Architecture: 60,00 points.
Contest 2: Engineering and Construction: 45,00 points.
Contest 3: Solar Systems and Hot Water: 58,00 points.
Contest 4: Electrical Energy Balance: 112,91 points.
Contest 5: Comfort Conditions: 65,89 points.
Contest 6: Appliances and Functioning: 103,30 points.
Contest 7: Communication and Social Awareness: 11,00 points.
Contest 8: Industrialization and Market Viability: 38,70 points.
Contest 9: Innovation: 30,50 points.
Contest 10: Sustainability: 60,00 points.
Bonus Points and Penalties: -0,50 points.

Introduction and Main Objectives of the Project

As the first Chinese participant in the Solar Decathlon Europe, we wanted to propose a solar house with a Chinese cultural identity, even though the footprint of the house was merely 74 m². We built a Chinese courtyard house which basic spatial organization had to be adapted in order to fulfill the criteria of competition, in terms of geographical location, climatic conditions, industrial form, spatial layout, materials and means of construction.

The key idea of our prototype was to create a mini-courtyard (or, a "patio"), surrounded by living spaces which are partitioned by folding screens. It features Chinese native plant, bamboo, the courtyard provides a "visual focus" and offers a miniature garden. The result is a circular space sequence illustrating the spirit and style of living of the Chinese.

Architectural Design

The patio is in the middle of the house, enhancing the efficiency of day-lighting and natural ventilation for the surrounding spaces. On the west side of the patio we find a private area (the bedroom); on the east side, a public area with the entrance lobby and the dining room. The kitchen and other water related areas are located north; finally, the living room is to the south. All the spaces are heated or cooled according to the needs of the residents.

The patio is covered by openable, inclined skylights.

During the day in winter, glass skylights allow daylight and sun heat into the house; at night, an insulated curtain can be added. During the summer, a shuttered curtain provides sun-shading. Natural ventilation can be achieved by either opening the skylights (more or less depending on the needs), or through a passive ventilator integrated into its frame. Consequently, the patio serves as a micro-climate buffer zone: it optimizes day-lighting, ventilation, and the insulation of the house.

Even though the floor surface of the Sunflower House is of only 74m² (counting in the patio), the living space is flexible enough to accommodate a wide variety of activities, thanks to reconfigurable partition screens and furniture.

Exterior design. Our design combines existing and new technologies in developing both passive and active strategies for the solar envelope of the house. The high quality of the envelope is essential to the thermal performance of the house. The idea is to offer a good balance between efficiency and affordability.

For passive energy saving components, high efficient insulation panels were fixed to the walls, roof and floor. For the exterior envelop of the building, we used a composite wall of insulating layer, water prove layer and decoration layer, which maintains a highly stable insulation while decorating the building façade. We also improved the air tightness of the doors and windows as well as the ventilation openings, and minimized air infiltration while heating, in order to meet the standard of IAQ.

Appropriate solar shading can largely reduce air conditioning loads in the summer. Shading elements such as photovoltaic panels and sunshade blinders inside the glass panels of the windows provide the building with a unique interior and exterior environment. The shading blinders are automatically controlled through lighting and air flow sensors, so to adjust indoor lighting and heat gain. We partly applied a glazing wall to the exterior envelop; we used triple glazing with low-E and Argon to minimize the U-value.

Interior design. The interior design of the house follows three principles:

- Transparency: modern life demands transparency. In terms of housing, it means needs for outdoor views, natural light, and openings. The fenestration of the house allows a maximum transparency without losing thermal efficiency. Even the floor of the patio is made of glass, together with the skylights above, which is a metaphor of "connection to the heaven and the earth".
- Chinese decoration style: furniture of the living spaces of our solar house are "traditional Chinese" in style. The bed is an adapted version of the traditional Chinese furniture, which functions both as a couch for meeting friends and as a bed because of its reconfigurable feature.
- Compact settings: the furniture of the kitchen is integrated with facilities. The bathroom comprises an integrated water closet. The setting of the wet area is extremely compact, so to save room without lowering the quality of bathing and cooking.

Construction and Materials

Most of the building components are prefabricated and divided in pieces which size is suitable for transportation. This is not only to comply with the time constraints in terms of construction (SDE rules), but also a consideration regarding future market applications in China.

We opted for a wood frame structure. The whole structure consists of wood column, beam and hybrid panels. The wood columns are made from SPF (spruce-pine-fir), wood beams from PSL (parallel strand lumber). Wall panels and floor panels are hybrid ones, consisting of facing layer, adhesive layer and inner lumber. The facing layer is made of OSB (oriented strand board), the adhesive is made of EPS (expandable polystyrene) and the inner lumber is made of SPF.

PSL is manufactured from strands of single wood species, or species combinations, oriented parallel

to the length of the lumber and coated with a phenol-formaldehyde adhesive.

SPF presents advantages: high hardness, high abrasion resistance, easy and fast dry, small crack path and dimensional stability. SPF is widely used for brackets, bridge parts, wood structures and commercial buildings.

Our solar house is light in weight and have little limit to the foundation. Joints and nailing can be handled with simple tools. We used a thermal insulation/ decoration integrated technology, so modular blocks can be installed quickly. No wet operations, neither high level skills are required. The house can be installed by a dozen workers on site quickly and precisely, occasionally with the help of machines. This highly industrialized house presents little construction waste, and employs a variety of recyclable materials.

The envelope of the house is made of lightweight SIP panels, which we chose for lightness, low loading, and convenient installation. However, lightweight walls are very poor for sound insulation and low surface density. Consequently, we had to use additional wall materials and special construction method in order to improve the sound insulation of the walls.

Interior comfort, HVAC and House systems

The radiation panels combine solar heat collection technology and low temperature radiation cooling technology. They can be integrated in the building facade or construction elements. They can also work together with heat pumps so to provide a sufficient heating or cooling capacity under extreme weather conditions, while maintaining high efficiency. They absorb not only heat from solar radiation, but also temperature drops at night, which can be directly or indirectly used as sources for the heat pump. Radiation panel system provides hot water, heating during the winter, and cooling during the summer.

The radiation panels are combined with heat pumps to provide heating and cooling. They can also be combined with vacuum pipes to provide hot water. The energy of the system comes from PV-radiant panels located on the southern and northern slope of the roof, and is distributed into the house through radiation panels (integrated in the walls or in the ceilings).

The Green Energy Laboratory of Tianjin University conducted an evaluation of completed projects using

this type of system. According to their report, the lowest indoor temperature reached by their prototype during the coldest winter days is 21.9 °C, which is higher than the national standard (18 °C). The highest summer indoor temperature is 23.8 °C lower than the national standard of 26 °C.

Initial costs for this type of system are similar to conventional heating and cooling systems. Because it uses renewable energy such as sun and air radiation, operation costs are much lower than for conventional systems though. The annual average energy consumption for hot water, heating and cooling do not reach more than 30kWh/m², and non-renewable energy consumption is reduced by 80%. It dramatically cuts down not only the operation and management costs, but also environmental impacts.

Cooling and heating mechanisms. The heat transfer fluid from the condenser enters the bottom of the radiation panel and is cooled down by low temperature absorbed from the air and sky. Then the cooled fluid goes back to the condenser; it absorbs the heat in the cryogen (as gas) and therefore liquefies it. When the liquid cryogen goes through the expansion valve, its pressure and temperature are reduced. Then it enters the evaporator, and conveys the coolness to the cool fluid and then to the end terminals. At the same time, the cryogen evaporates and enters the compressor, where gaseous cryogen is heated, compressed and then expelled into the condenser.

This happens again and again, and completes the cooling process. The mechanism of heating is similar to the cooling process.

When solar radiations are available, the system uses solar energy and heat of the air as energy resources. The heated fluid directly supply heat indoor through the panels or is stored. When cooling is needed, the system uses cool air and sky low temperatures as cooling sources. The cooled fluid is transported indoors through the radiation panels to lower the temperatures or is stored away. The indoor heat is expelled outdoors as well, through the radiation panels.

Solar Systems

Thermal solar system. The whole set of thermal solar installations for high and medium temperature are composed of solar thermal collectors, circulating pumps, pipeline systems, thermal insulation systems, control systems and other devices such as the storage

temperature water tank. Heat transfer oil is used as the circulating heat transfer medium in order to keep the system work at high temperature.

We used solar energy as heat source, through direct flow in 20 vacuum tubes of SUNDA. The heat transfer material used is oil, which provides high temperatures for water heating (60 °C) and the aforementioned oil (150-200 °C).

Photovoltaic solar system. We used a single-phase system with 230V, 50Hz, which comprises six PV generators, battery energy storage, loads and a controlled interconnection to the local LV grid. Both the battery unit and the PV generators are connected to the AC grid via fast-acting DC/AC power converters. The converters are properly controlled so the system can operate either in connection with the LV network (grid-tied), or in stand-alone (island) mode, and can smoothly switch from one to the other.

We installed a total of 24 PV modules on the flat roof for an area of 35.6 m², and 24 PV modules on the parapet, for an area of 6.35 m². The PV modules are made of high efficiency mono-crystalline silicon cells, each of which is 200Wp for the roof, and 30Wp on the parapet.

In order to prevent the fluctuation of solar energy generation and of the energy demand, we used a battery storage unit with a bi-directional inverter ensuring power balance and a stable operation of the system. Especially when the system runs in island mode, the bi-directional inverter regulates voltage and frequency, and controls active and reactive power through absorbing or releasing energy.



cold water storage tank

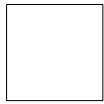

Green

Green

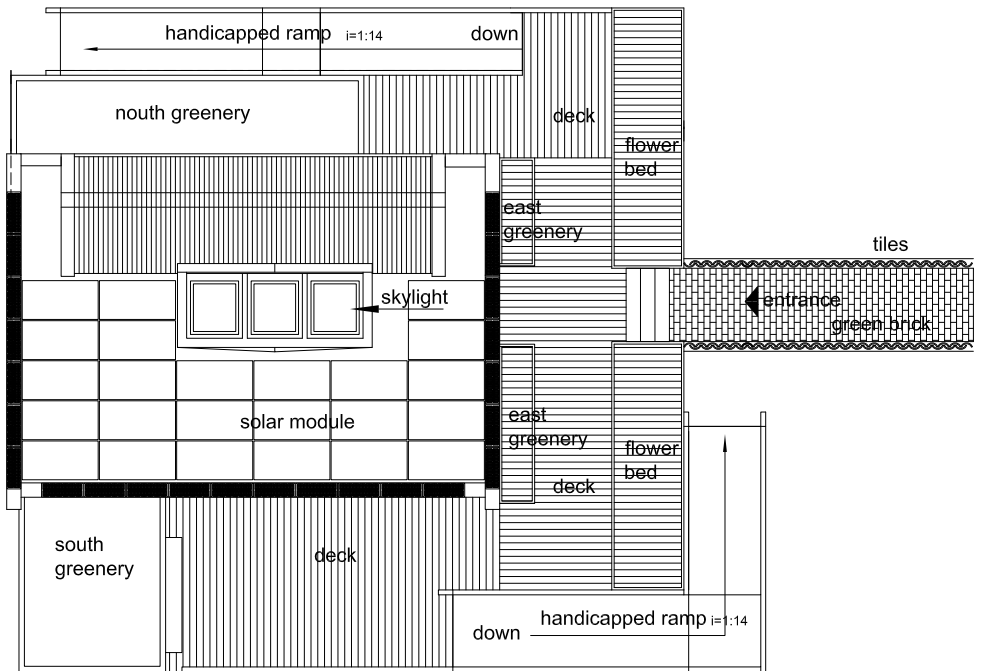

Site plan

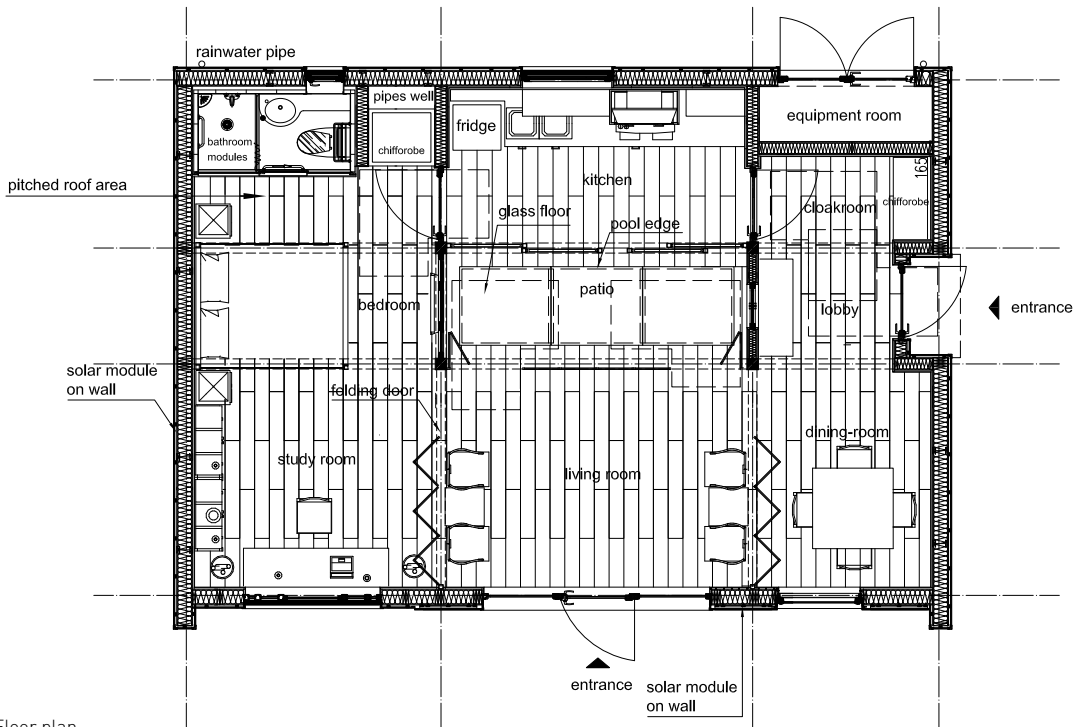

Floor plan

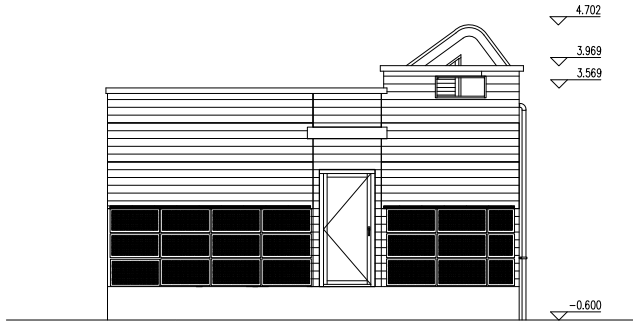

East elevation

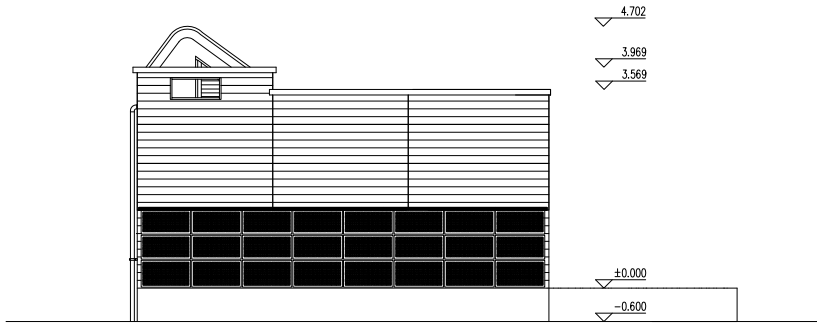

West elevation

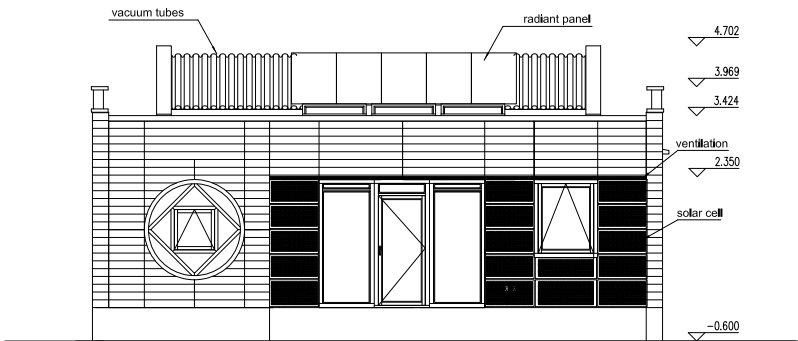

South elevation

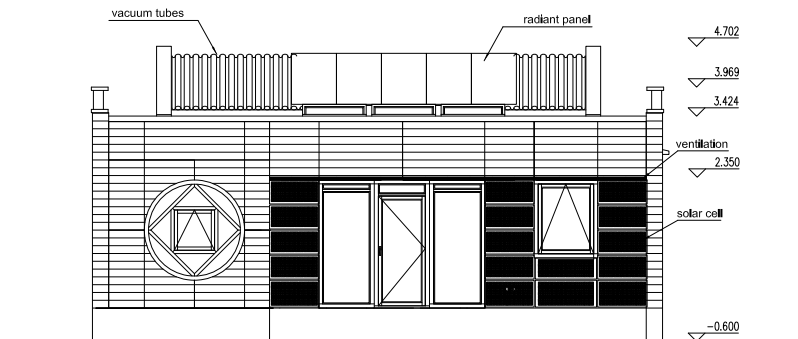

North elevation

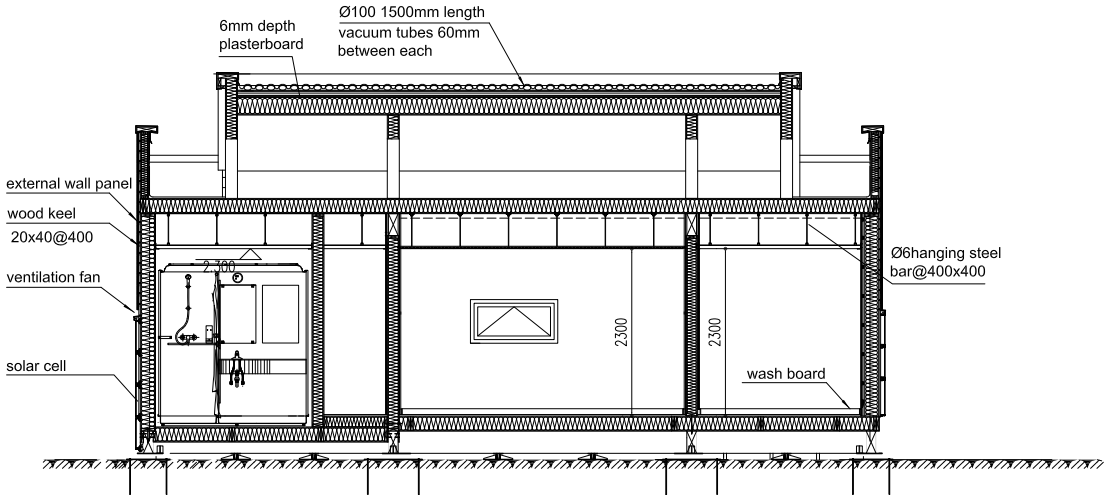

Transversal section 1

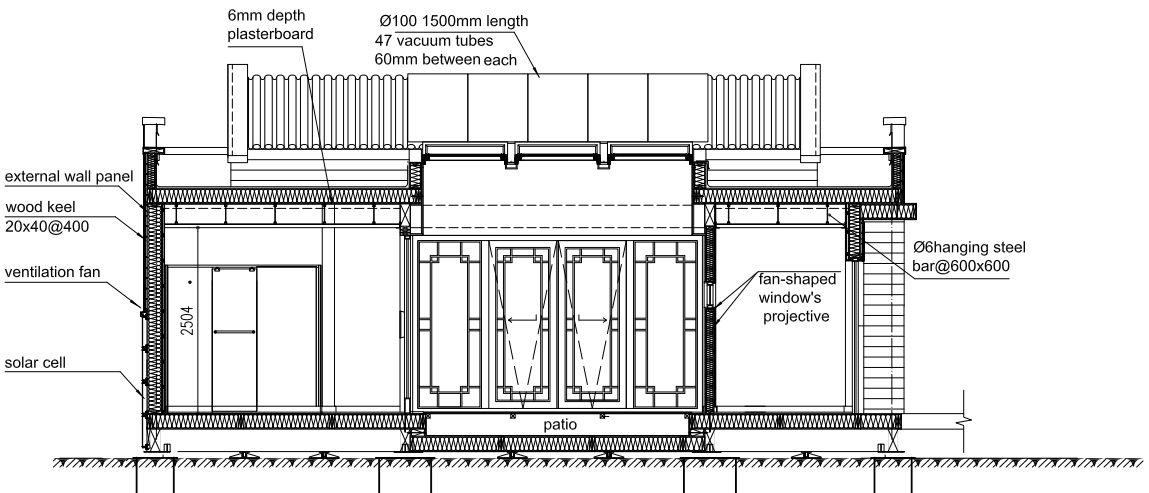

Transversal section 2

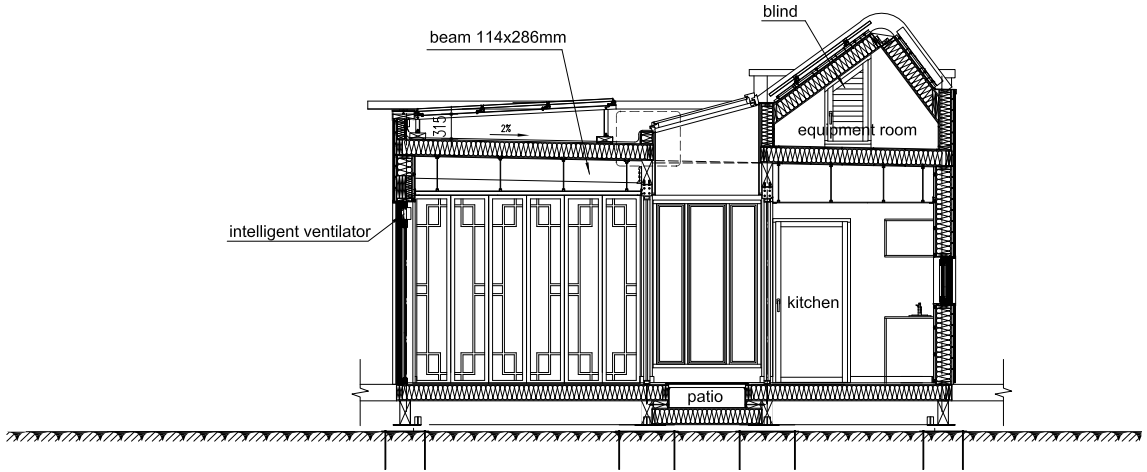

Longitudinal section 1

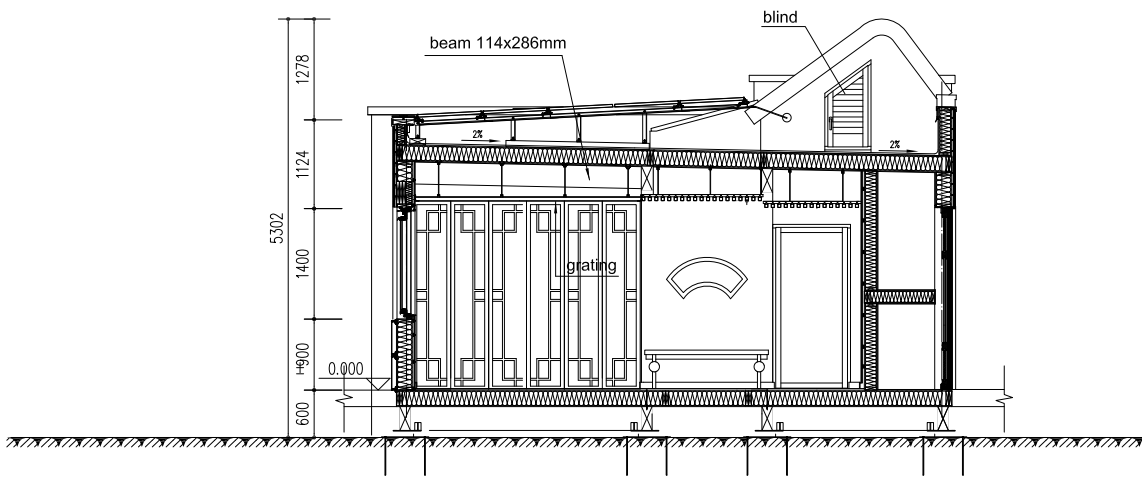

Longitudinal section 2

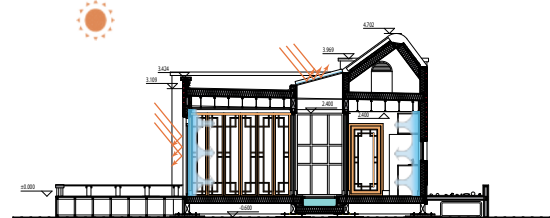
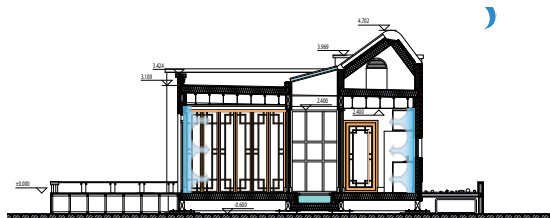
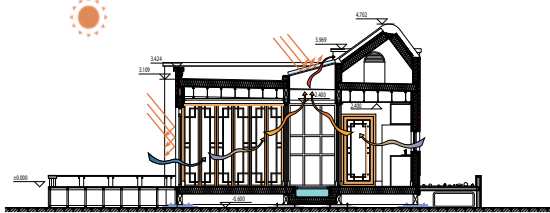
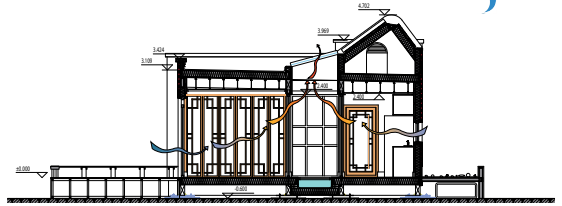
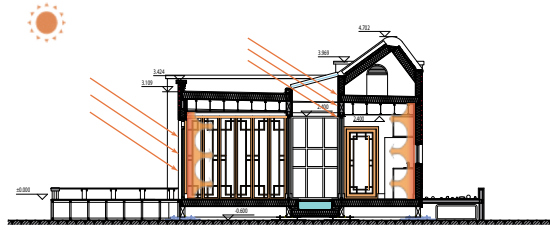
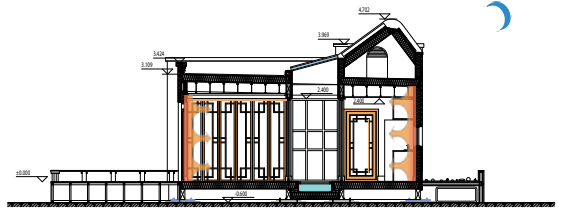

TECHNICAL DATA OF THE HOUSE

Project name:
SUNFLOWER

Construction area:
68,05 m²

Conditioned area:
44,00 m²

Conditioned Volume:
227,97 m³

ENERGY BALANCE

Estimated energy balance:
+2.715 kWh/a

Estimated CO₂ emissions:
4.360 kgCO₂/a

Estimated energy production Madrid:
9.982 kWh/a

Photovoltaic system:
Total installed PV power:
8,42 kWp

Types of PV Modules:

Roof: 12 series, 2 parallel connected-mono crystal Si,30W. 5 series,1 parallel connected-mono crystal Si,195W per model.

West: 8 series, 3 parallel connected-Poly crystal Si,38W per model.

East: 7 series, 2 parallel connected-Poly crystal Si,38W per model

South: 9 series, 2 parallel connected-Poly crystal Si,38W per model

Inverters: 4 PVI-2000-OUTD-ES

ENERGY CONSUMPTION

Estimated energy consumption Madrid:
7.267 kWh/a

Estimated electrical consumption Madrid:
165 kWh/m²a

Characterization of energy use :

Appliances+various electrical uses 2.966 kWh/a

HVAC 1.705 kWh/a

DHW 784 kWh/a

Automation 1.051 kWh/a

Lighting 967 kWh/a

CONSTRUCTION ENVELOPE

Insulation types (type and thickness and thermal conductivity):

Type	Structural insulated panel
Width (mm)	200
Thermal Conductivity (W/mK)	0,042

Constructive Systems thermal transmittance:

Opaque wall 0,22 W/m²K

Glazing 1,40 W/m²K

Floor 0,181 W/m²K

Roof 0,181 W/m²K

COSTS

Construction Cost:
247.090 €

Industrialized Estimate Cost:
25.000 €

FabLab House

Instituto de Arquitectura Avanzada de Catalunya, Spain



Nº.17 / 582,81 points

Contest 1: Architecture: 78,00 points.

Contest 2: Engineering and Construction: 45,00 points.

Contest 3: Solar Systems and Hot Water: 55,17 points.

Contest 4: Electrical Energy Balance: 108,51 points.

Contest 5: Comfort Conditions: 46,84 points.

Contest 6: Appliances and Functioning: 52,74 points.

Contest 7: Communication and Social Awareness: 29,30 points.

Contest 8: Industrialization and Market Viability: 41,30 points.

Contest 9: Innovation: 38,95 points.

Contest 10: Sustainability: 100,00 points.

Bonus Points and Penalties: -13,00 points.

Introduction and Main Objectives of the Project

FabLab House shows that other ways of thinking, designing, manufacturing and communicating, currently just emerging, can be completely applied to homes.

Our prototype pursues three aims, three paradigm shifts:

First, we opted for a different type of industrialization process. In contrast with the mass industrialization of standard products, digital design techniques and new customized manufacturing, as well as CAD CAM and similar technologies of design and manufacturing offer many possibilities for "adaptation". Specific needs call for specific solutions. In that spirit we proposed, in developing our project, international Fab Labs network as a new way of conceiving the architectural production.

Second, we used an extended definition of technological efficiency. Our objective was to add an accessibility factor to the idea of efficiency, and to apply those values to all the designs of the prototype, from its structure to its finishing. For example, we suggested that measuring the efficiency of a photosensitive material should take into account (instead of its strict energy efficiency) its price; its availability; its technological complexity/difficulty; its options in terms of usage; the capacity of being easily assembled, transformed, adapted and maintained; and its energy collection capacity. The intention behind such a "shift in perspective" was to make users be part of the space they live in, and let them transform it.

Third, we adopted a systematic or holistic approach in terms of distributed intelligence and general design of the house. We wanted to avoid the problem of integrating systems or architectural elements relying on different or conflicting logics. Each element of the house was given the same logical structure and integrated as a whole (i.e. that each element both reflects and contributes to a consistent, general logic).

Architectural Design

A solar house cannot be a house (meaning a box) with solar panels. A solar house is a new way of approaching architecture starting from scratch: it sees the building as an organism which is made up of the energies it is surrounded by, and which works with them.

Our prototype is inspired by three basic concepts:

Form Follows Energy. In the 20th century, it was suggested that "form follows function". In the 21st century, "form follows energy". The dwelling is not a machine anymore, but an inhabited organism.

Our solar envelope calculation resulted in a paraboloidal shape. It is lifted on three supporting elements with contain services as water, electricity and HVAC, and induce two energy balanced moves at the same time. It conserves the energy, just as an igloo. Geometrically, spheres have the smallest form factor; they present the most efficient surface to meet comfort conditions. Considering sun path, we adapted the sphere design in order to maximize sun energy collection.

The solar surface was optimized by eliminating joints and holes: it becomes a continuous PV skin with a variable geometry. We only reduced the surface, making room for the semi-spherical solar heaters. The PV plastic skin, assembled on transversal strips, reinforces the epithelial ventilation of the facade.

Thanks to digital fabrication techniques, optimum geometry and the amount of construction materials can be combined with precision and without simplifications.

A house, a tree. Our solar house is a tree. Our prototype is completely made of wood. It is a renewable resource generated by the sun: the solar material *par excellence*. A white pine tree (32 m³ of wood) is all you need to build a solar house.

The house, just as the white pine it comes from, is totally self-sufficient. It produces energy through its solar "leaves", and sends it to the roots where it is stored, and then redistributed to the house in order to produce "electricity fruits".

We managed to produce the most efficient, flexible solar panels in the world. Like tree leaves, they are light and easy to handle; they can be cut by hand and screwed at any point. The laminate on Teflon and EVA composite of SunPower monocrystalline cells allows us to do almost anything with them.

Batteries are located in the east column. They act as roots and store the energy surplus. The house produces at least twice the energy it consumes. Extra energy could either be sold to the electrical grid, or used to provide energy for other houses with less efficient systems.

A passive climate structure. We lifted our prototype off the ground in order to create a shade underneath. Even though we were well aware of the earth's natural insulation properties, we decided not to use it. Rather, we explored new solutions such as ventilation strategies, evaporative cooling, structural core with thermal inertia, use of wind dynamics, etc.

In doing so, we: 1) minimized environmental impact (the house touches the ground just in three points); 2) doubled the habitable or useful space (since we kept the house above the garden / lot) and 3) we echoed the Mediterranean lifestyle by including a shaded porch connected to the garden.

Fab Lab House uses environmental resources (sun, water and wind) to create a microclimate that improves

in a passive way the basic conditions of inhabitation.

The space beneath the house becomes the most important space of the house. By passive conditioning only (shade + wind), the "exterior" temperature gets several degrees lower. The space is full of people having a rest... or producing! A house is not a machine: it is a habitat.

Construction and Materials

Industrialization systems: Customized digital fabrication. We are witnessing a paradigm shift within the field of productive processes. New industrialization models are sketched. Massive, standardized products (the mass production models of the first industrialization period), are progressively replaced by more individualized and specialized processes like customized manufacturing, where passive consumers become active producers.

Our work is based on an initiative of the Center for Bits and Atoms of the Massachusetts Institute of Technology (MIT). We aim at creating a global network of digital fabrication laboratories (Fab Labs).

Although Fab Lab is a small scale workshop, we have the infrastructures and tools to manufacture almost anything - even products that are usually associated with mass production. Of course, it cannot compete with large scale production and distribution, yet it offers freedom and creativity: something big productive systems and related commercial interests do not allow. Consequently, it adapts to the most local or individual needs, providing advanced solutions for a variety of contemporary situations.

Fab Lab distribute all over the world. Each Fab Lab is specialized in specific architectural elements, creating a global knowledge network which makes "the local" and "the global" work all together. This way, the design process can be imported to different places and at different scales; knowledge can be shared among different technological fields. At the same time, thanks to the common protocol of this laboratory network (they speak the same technical language and use the same software and basic machines), prototypes can be locally built almost anywhere in the world. They reduce costs and easily adapt to the use of different material, or to specific technological conditions.

Productive models of the 21st century differ a lot from the previous "dimensional standardization" of

products. The modular repetition of an element is not a prerequisite anymore. The main prerequisites are now 1) the adaptation of the geometry to the climate (by using prevailing winds; by generating shade spaces and making better use of them by using materials with thermal inertia; by positioning solar surfaces according to a wide season range and not only at the maximum efficiency points, etc.), 2) the optimization of the materials (understanding the cutting processes of materials), and 3) the adaptation of the constructive system to the assembly phase (reducing the auxiliary lifting structures needed).

Constructive systems: structure and skin. We wanted to understand technological efficiency in a wide sense. We thought that an architecture project is not finished as soon as it is assembled; it continues throughout the life of the device. In fact, the project is "activated" when interacting with the user. In that respect, we wanted the user to get further involved in every step of the process.

Materials: wood is a material that is easy to find all over the world, in industrialized countries as well as in underdeveloped countries. It is a light material that is easily handled. Everybody understands the way it works. It is also a solar material. It grows with the sun, and represents a renewable resource: a well-managed, rationalized production is advisable for the preservation of the land. In using wood, our factories help protecting natural resources.

Structure: our prototype has been lifted off the ground, creating a shade underneath. A series of wood ribs form the shell, which is supported by three feet. Its arch-shaped geometry enables light conservation between the feet, while ensuring the best load distribution. It works like the structure of a boat: the structure and the skin are the same thing. The ribs are close to each other, defining a precise, free geometry. Distributed that way, the structure allows small sections: pieces are light and can easily be handled. The use of heavy technical display, complex constructions, or structural excesses are therefore avoided.

Skin: we focused on an integrated understanding of the construction. In contrast with the idea of a "box with holes and solar panels on the roof", we opted for a continuous skin which fulfills the requirements and solves problems of the envelope. The skin gradually changes depending on its orientation (by adding or eliminating layers). It solves structure, insulation, ventilation, lighting and energy collection problems all together. For example, we used glass for the south floor, perforated wood for

the technical feet, and wood and insulating plants on the north side; we covered the high-performance solar envelope with wood, insulating material, ventilation and PV panels, etc.

Far from the typical "box + panel", the smallest pieces of our prototype, i.e. each minimal element includes all the information, all the necessary intelligence and processes involved in the prototype development: it is a unitary, continuous organism.

Interior Comfort, HVAC and House System

In terms of energy, two options exist for a balanced comfort strategy.

We can choose big, expensive manufacturing, maintenance and production means. Expensive conditioning, lighting or ventilation systems not only consume a lot, but they also pollute a lot.

We can also choose to reduce consumption by using some passive elements such as double skin, or traditional systems such as natural ventilation (which may be less precise but are much more affordable and less polluting, while meeting the comfort conditions). Lower production parameters lower the costs, and render accessible simpler technologies for the user, such as flexible solar panels or spherical water heaters.

Obviously, we chose the second option.

Shade space: In contrast with a design strictly or mainly focusing on interior comfort (inherited from the "culture of inhabiting" of countries located at different latitudes), we considered the exterior living space as important as (even more maybe) the house itself. The space underneath the house is protected from the sun and oriented according to prevailing winds. It connects to the garden and to the systems placed in the feet; it is the main social area of the house. Moreover, it generates a shade buffer which is used by the conditioning system: the air it treats is already pre-cooled. We used the same strategy for the west porch and the access stairs, which are protected by the perforated skin. We surrounded it with plants (fruit trees and vines on the south side; aromatic plants and flowers on the west one) in order to reinforce the natural pre-treatment of the air.

Natural ventilation: two natural ventilation cycles occur, with the help of the two shade buffers. The first one (south-north) is mainly exterior: it covers the whole paraboloid skin of the prototype, refreshing it through

the double skin. The second one (east-west) is mainly interior, going through the two big windows of the house.

Conditioning system. Since our building is low demanding, we can use low energy systems such as radiant floors, ventilation-conditioning with adiabatic recovery using the air of the shade space, minimum solar storage for sanitary hot water through spherical collectors, etc. These systems do not require a lot of power, neither big pumps, large number of solar collectors, high cooling flows, and so on. Therefore, they easily achieve high energy performance (IEE, energy certification, etc.).

Lighting systems: artificial and natural. We conceived the structure as an incomplete paraboloid. That way, we reduced the south openings in order to minimize direct radiation on the glass. The main openings are located on the east and west sides. The east one heats the house in the morning, counteracting overnight temperature drops. During the rest of the day, it collects indirect light. The west opening, the access, is set 3 m back in order to protect it from direct radiation (which is important in Madrid). On the south side, pixelated holes are protected by the structure (it works as integrated *brise-soleils*).

The glazing is set back in its upper side. Because the glazing is not aligned with the facade, it gives shading to the interior.

For artificial lighting, we used two different type of low-consumption LEDs. On the one hand, a system of diffuse and warm lighting: lineal elements are distributed all over the dome and integrated into the gilded roof of the house, which act as reflectors. On the other hand, a more cold and intense lighting where specific needs are more demanding (for the workstation, dining room, kitchen, etc.)

Solar Systems

PV systems. We produced, for our prototype, the most efficient flexible solar panels in the world. When first browsing for efficient, flexible PV products, we noticed that existing PV fabrics have a maximum efficiency of 6%. We decided to create a flexible panel with monocrystalline cells (which surprised the cell manufacturers themselves).

SunPower rigid and monocrystalline cells, which have a 22% theoretical efficiency, are assembled on flexible EVA panels covered by a sheet of Teflon in a workshop.

The result is a low-cost and flexible panel which has the same efficiency as rigid cells.

The panels are directly screwed to the transversal wooden strips. As they are plastic sheets, they can be joined with a bolt on a rubber washer; they can be pierced, cut or folded. In short, they easily adapt to the geometry of the surface, more or less like a solar suit. This way, we avoid geometrical rigidity as well as expensive and complex standard mounting systems.

Thermosolar systems. In order to be consistent with the philosophy of our project, we opted for a cheap, transparent, adaptable, and easily reproducible technology for solar heaters. The semi-spherical solar heaters adapt themselves perfectly to the geometry of the prototype and, thanks to their spherical surface, they receive homogeneous solar radiation throughout the whole day, without needing a specific orientation or inclination. This system is very light (8 kg/u) and does not request specialized workers for its assembly. The materials used for its production are "ordinary" and easy to use. Its base consists of an insulating reflective surface made of aluminum. Over it, a double polymethacrylate dome with a corrugated tube (25 mm of diameter) acts as an absorber. A dome of 1 m diameter can generate 3 m² of heat surface with a water absorption of 9l.

The output of the collector is especially high for situations of low thermal gradient and average radiations of 800kw/m², so it is especially indicated for low temperature uses.



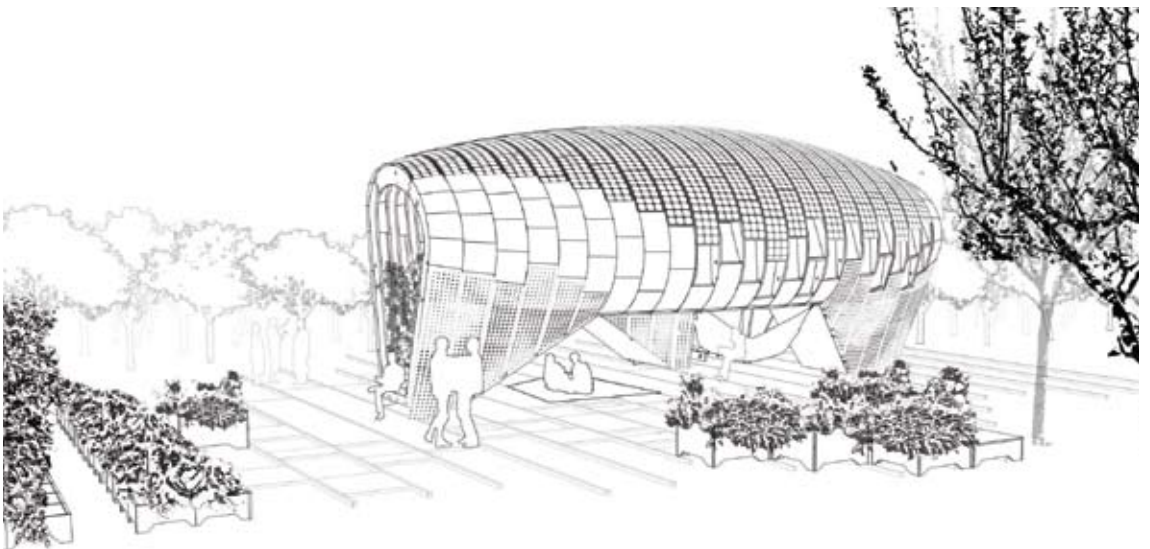
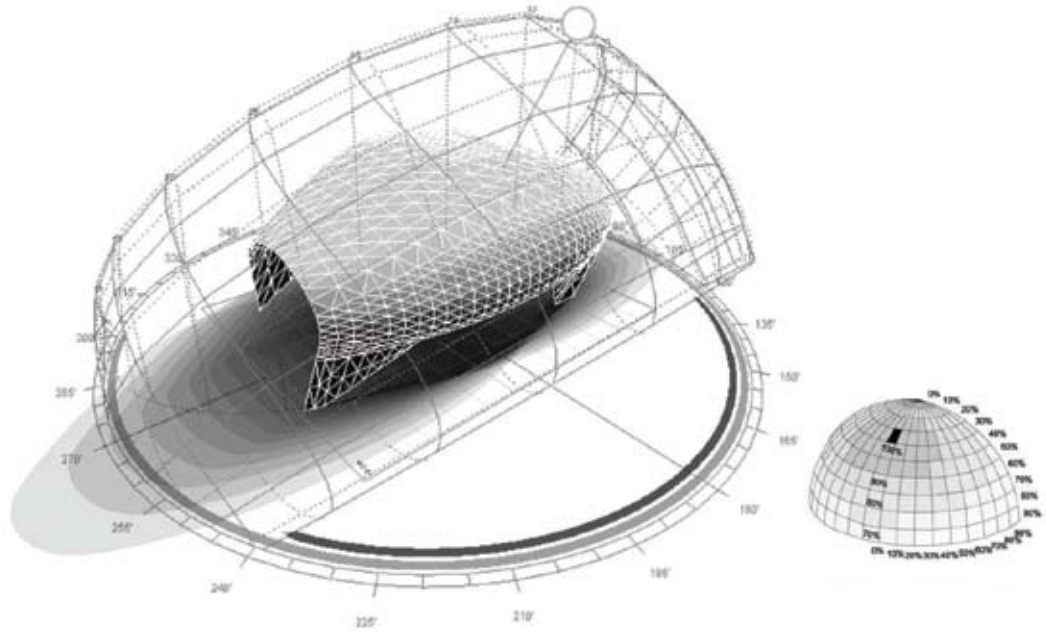

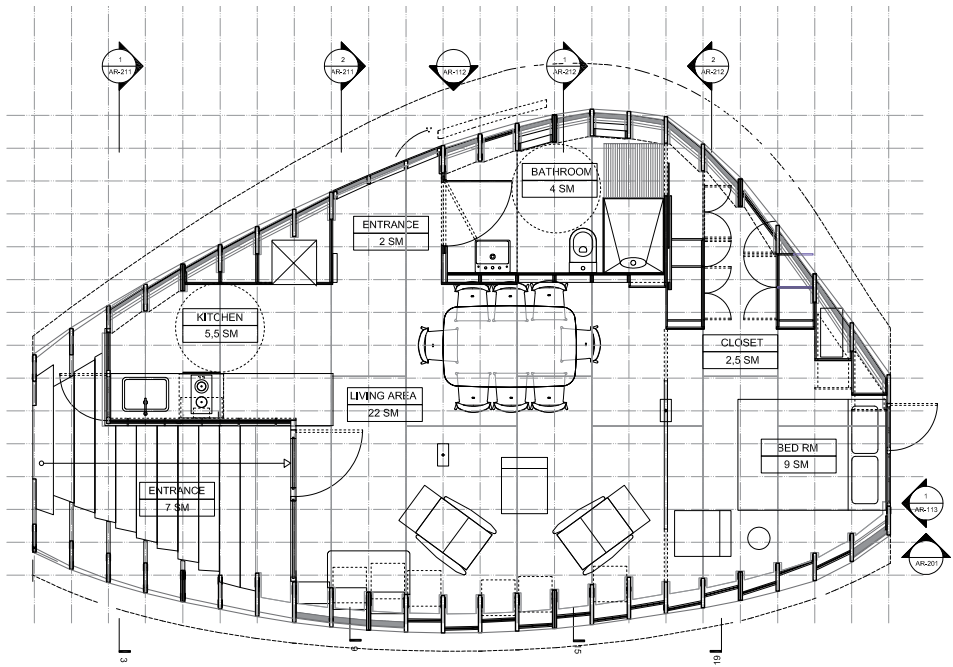

Floor plan

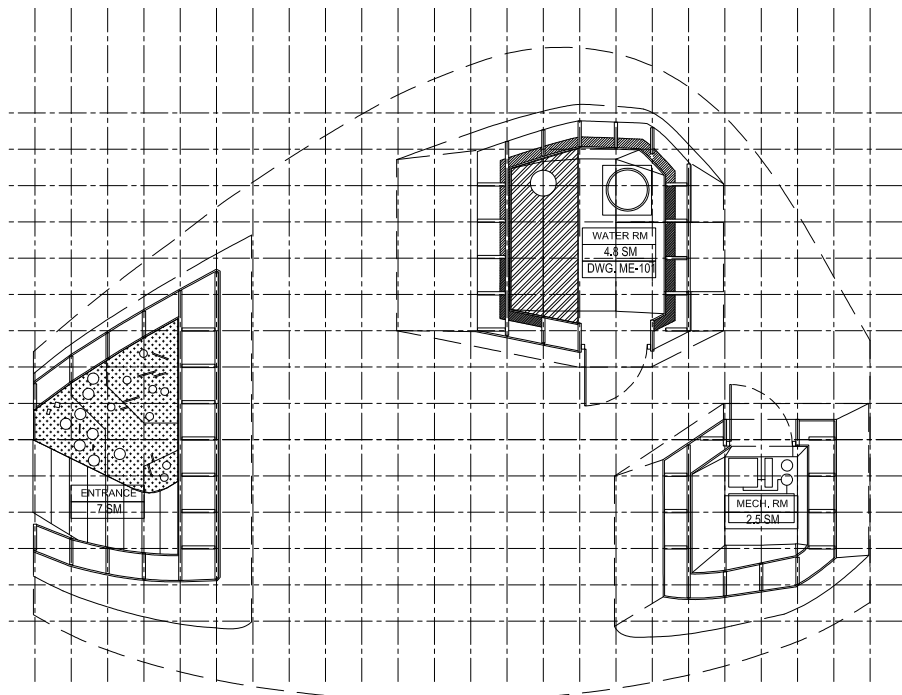

First floor plan

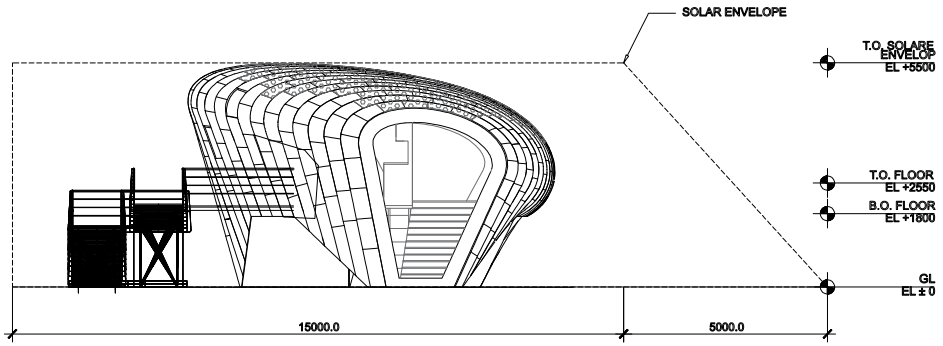

East site elevation

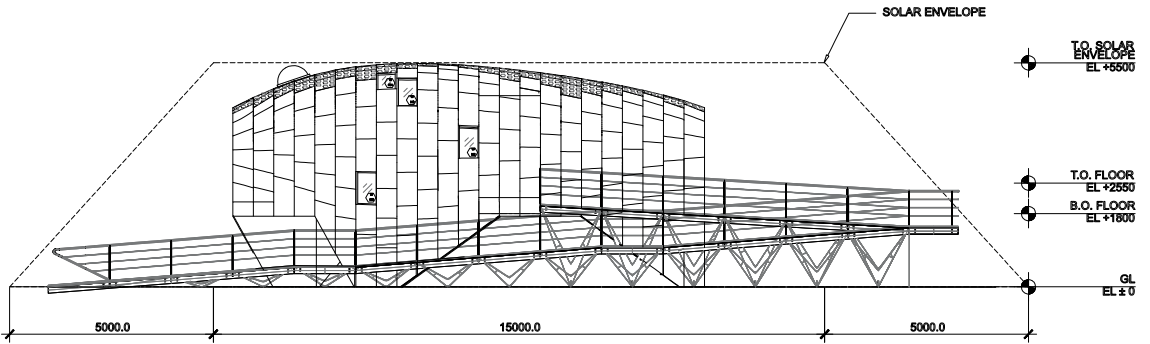

North site elevation

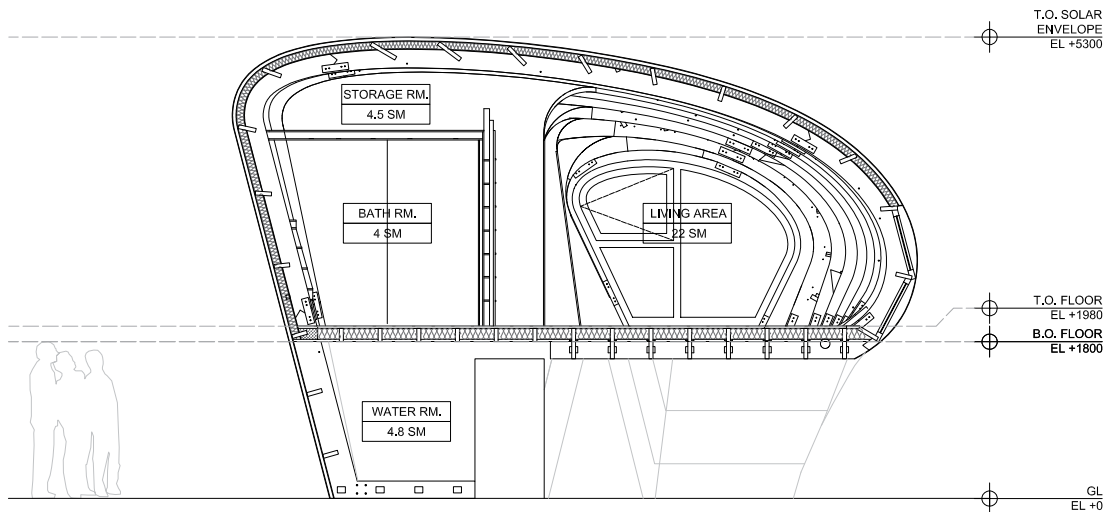

Section

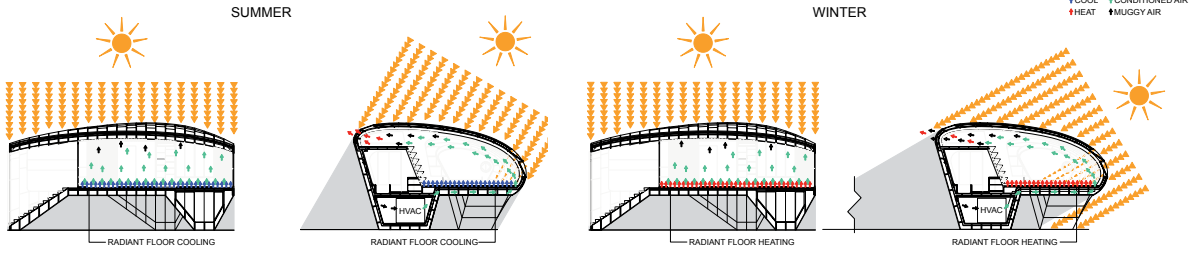

Bioclimatic analysis

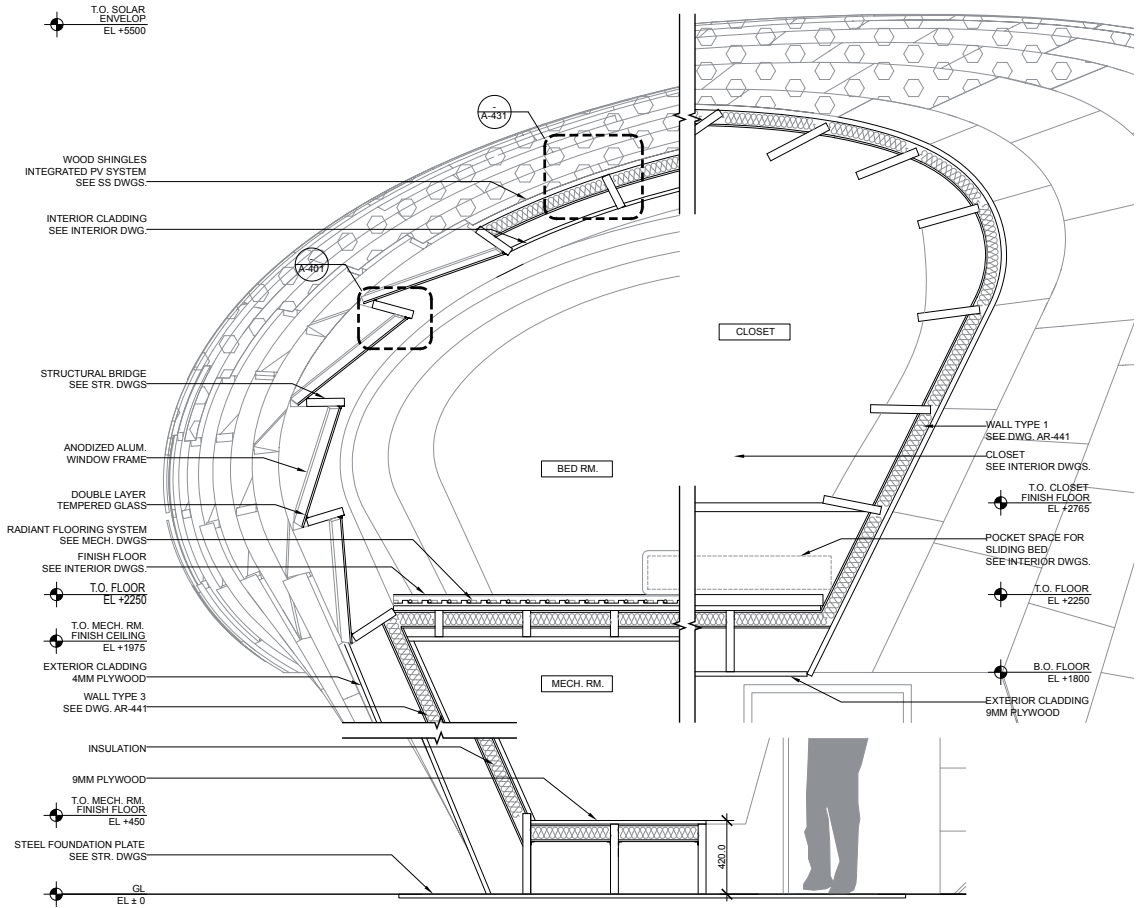

Detail wall section

TECHNICAL DATA OF THE HOUSE

Project name:
FabLab House

Construction area:
73,5m²

Conditioned area:
57,4m²

Conditioned Volume:
149,2m³

ENERGY BALANCE

Estimated energy balance:
+2.489 kWh/a

Estimated CO₂ emissions:
3.781 kg/a

Estimated energy production:
11.942 kWh/a

Photovoltaic system:
Total installed PV power (kW)::
8,54 kW

Types of PV Modules:
Mono crystal Si s/EVA-teflon
B.I.P.V. Based on 21 x C50 H2 Sunpower cells

ENERGY CONSUMPTION

Estimated energy consumption:
9.453 kWh/a

Estimated electrical consumption:
165 kWh/m²a

Characterization of energy use:
35% heating
23% appliances/power points
21% miscellaneous
18% cooling
3% lighting

CONSTRUCTION ENVELOPE

Insulation types (type and thickness):
Hemp BIOKLIMA 10cm

SPECIAL AND INNOVATIVE SYSTEMS

Flexible panels with TFM-Sunpower monocrystalline cells
Water heating through spherical collectors
Water treatment and reuse for watering

COSTS

Construction Cost:
450.000 €

Industrialized Estimate Cost:
220.000 €

Prototype SDE 10

Universidad Politécnica de Madrid, Spain

Introduction and Main Objectives of the Project

The objective of the project is to develop a new industrialized, light, sustainable and energy efficient construction system. The system must be competitive and focus on energy savings and related GHG emissions.

The SD10 prototype was used as the “headquarter” of the organization during the Solar Decathlon Europe 2010 competition. The building was not taking part in the competition and therefore didn't have to comply with its rules and specific constraints. For that reason, some of its characteristics differ from the rest of the prototypes.

The SD10 Prototype is strongly conditioned by the requirement of assemble and dissemble, once Solar Decathlon Europe 2010 is over it will be taken again into Solar Decathlon Europe 2012, in the meantime it will be used as research demonstration and experimental building.

Various experiments conducted by the TISE Research Group¹ took place in the building.

The group has been working on the design of innovative technical solutions developing high performance, industrialized light systems, which allow the generation of homes characterized as follows:

- Industrialized system.
- Versatile system.
- High quality.

- Efficient construction.
- Both spatial and formal resolution, customized and adapted to the needs of the client.
- Improved conditions of sustainability, and optimization of energy-related costs and of the life cycle of the building.
- Bioclimatic architecture.
- Environmental intelligence system.
- Maximum use of solar thermal and photovoltaic, aiming at maximizing energy efficiency.
- Integration of active and passive systems.

The SD10 Prototype is not a house itself, the design comes from a collective housing design which was the result of the research activities of the INVISO (Industrialized sustainable building) project.

The INVISO building is a combination of 3D and 2D construction modules. A 4 floors block was developed, and should serve to generate the necessary knowledge to extrapolate this type of buildings up to 8 or 10 heights.

The SD10 building is a prototype of the basic unit that will be replicated in a block.

Architectural Design

Prototype SD10 was designed according to functional and bioclimatic criteria. In terms of functionality, the prototype had to provide a space large enough to suit the program and perform tasks required by the construction. We also wanted to design a fast and simple,

cutting-edge assembly and disassembly system that would revolutionize the industry. In terms of bioclimatic architecture, our goal was first and foremost to reduce the energy demand and, secondarily, to use renewable energy.

Exterior design. In order to reduce the energy consumption of the building, we used the following strategies:

- We considered a shape factor suitable for the climate in which the building was to be located, i.e. a compact shape, optimal for Madrid's extreme temperatures and dry climate.
- Composition, size and location of glazing surfaces were designed according to external and internal conditions.
- Solar protection devices were designed according to the orientation of the prototype.
- Composition of enclosures was based on high-performance multilayer elements, which is to say highly efficient components.
- We used cross ventilation and evaporative cooling

Interior design. The interior is design for a collective housing; the different areas are placed according to two requirements:

- Construction System: The 3D-2D modules system was design so to reduce transportation costs, preventing from having to carry empty modules. As a consequence of this choice, the mechanical room, the bathroom and the kitchen had to be located in the 3D modules, and the living areas in the 2D modules.
- Orientation was thought so to optimize the possibilities of the spaces: Spaces where occupants are likely to spend more time and where long lasting tasks are likely to be performed were located south; The mechanical room and the entrance were located north, providing a thermal buffer. The mechanical room connects directly with the bathroom and the kitchen through the ceiling; Kitchens were located west and east.

During the competition the prototype was used as an open space office.

Construction and Materials

In addition to energy efficient materials, we used natural materials such as wood and cork for the structure, insulation and finish – therefore making our prototype even more sustainable. Such materials also make the interior and finishes warmer, creating a cozy ambiance for the users.

- 1.Exterior facade finish, cork.
- 2.Interior facade finish, blue and red cork.
- 3.Exterior floor finish, wood.
- 4.Interior floor finish, ceramic.

Natural elements such as a pond and a facade with plants were added to the architecture. Plants fulfil various functions and are well suited to Madrid's dry climate; they provide moisture to the air and reduce heat through evaporative cooling.

Industrialization systems. The main objective of the system was to obtain a lightweight industrialized construction enabling control over quality, costs, and time-related issues.

A proper control of the quality help making sure the performance of the building is satisfactory, and complies with requirements in terms of energy efficiency.

A problem that light systems usually have is a mingy acoustic performance, usually not enough for areas with high requirements. An important aim in this project is obtaining a system with a high acoustic performance.

The system consists of 3D elements entirely built in factory, and transported afterward. The 3D supports 7.20 m*2.40m 2D; front is closed with opaque and glass panels of 1.2 m. width and equal height to a plant.

Our experience of the assembling process at the Villa Solar was very compelling. The prototype was assembled in six hours; finishes, furniture and lighting were completed within two days. This is a very fast process. The previous building at the factory work lasted 3 months. Moreover, the dimensions of the

various components were designed so to avoid 'special' handling, thus lowering transportation costs.

House envelope. Specific technical objectives in regard to the envelope were to reduce the weight of the structure, to favour the use of fully recyclable materials, to have a dry construction, to reduce significantly the amount of waste generated, to reduce the embedded energy of materials, and to reduce the amount of energy needed for construction and transportation. Finally, since 70% of the costs are ensuing from labour and factory production, favouring "in situ" assembly and fastening its process was also important.

The use of multilayer high performance systems was thus indicated so to achieve the objectives aforementioned.

Opaque envelope. Our study of the thermal envelope and thermal calculations have been simulated with the program AnTherm.

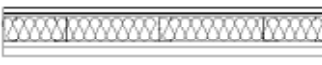
Envelope panel horizontal section	Composition
Interior  Exterior * total thickness: 18,25 cm	Interior finish: cork, 3mm thick Plasterboard panel: 15mm thick Acoustic layer: 4 mm thick Plasterboard panel: 12 mm thick Steel frame structure: 90 mm thick Fibreglass insulation: 80 mm thick OSB panel: 16 mm thick Exterior finish: cork , 40 mm thick
Isotherm	Heat flux
U= 0,38 W/m²K	

Glassing elements. Double Skin. A double skin glazing system was located south in the 3D module. The system acts as a thermal buffer: it protects the interior from cold at night and during the winter, and from heat during the day or at summertime. In the winter, the system takes

advantage of green garden effects during the day; in the summer, natural ventilation is allowed overnight. The system can be considered a 'passive preconditioning' system.

Glassing elements. Dynamic glazing panels. Two dynamic 2D panels were also located south. The panels comprise a double glazing surface and a heat exchanger which function is to precondition the air. Active elements are controlled according to environmental conditions and adapt to the needs of the user.

Criteria for the selection of materials. The main material selection criteria are to design a construction system which integrates several objectives: energy efficient material, sustainable materials, 8-10 floor building systems, industrialized system and light and dry construction.

A problem that light systems usually have is a mingy acoustic performance, usually not enough for areas with high requirements. An important aim in this project is obtaining a system with a high acoustic performance, this has an important impact in the material selection.

Interior Comfort and House Systems

The mechanical room, which is located north, harbors the elements needed to make the Systems work.

The ducts of each system are driven from the technical room through the ceiling.

For the distribution of electricity, we designed 'technical galleries' on the floors and ceilings. The technical galleries follow an axis parallel to the structure, and are used for assembly or disassembly.

Conditioning systems: We opted for efficient air conditioning systems.

Bio cool system: Evaporative cooling systems work according the following principle: the air encounters water; evaporation occurs, which lowers the temperature and moisturize the air.

Heating and cooling systems were integrated to radiant floors and ceilings.

We opted for a Microled lighting efficient system.

We also installed control building systems in order to guarantee comfortable conditions for the user while ensuring energy efficiency.

Finally, computers and appliances were selected following their low consumption characteristics.

Solar Systems

Photovoltaic system. The SD10 prototype has a 0° inclination pergola with 130 CdTe "Cadmium Telluride" high efficiency photovoltaic modules which compose the generation subsystem. These modules have a major absorption of diffuse solar irradiation in cloudy conditions, and a better output/performance at high temperatures, under normal use and direct solar irradiation.

It is also worth mentioning that both semiconductors and covering glass materials included in the modules may be recycled up to 90% (once the life cycle of the module is over).

Apart from this, we used three sunny boy inverters of 3300W for the power conditioning subsystem, as well as 48 batteries "12 OPzV 1500" for the storage subsystem. These subsystems are managed by a Sunny Backup, which role is to charge or discharge the batteries, and for administering the consumption or waste into the grid.

Thermal solar systems. A solar thermal system is used for hot water and conditioning radiant floor and ceiling. We opted for a DERAIT System, which specificity is to regulate the pressure of the solar circuit and to avoid discharges of antifreeze fluid, when heat excesses generate pressure in the collectors. Such technological innovation does not consume electricity: it saves energy, while guarantying the protection of the solar installation at any time, even if

power disruptions occur. It also comprises less elements than most of conventional systems, which makes its assembly faster.

Singular and Special Systems or House Elements

The prototype SD10 is currently located at PAAS (Automation Platform for Sustainable Architecture). It is being used for research purposes by the TISE group.

The TISE Research Group have been working, within the last few years, on several research projects about industrialization, sustainability, energy efficiency and acoustics in buildings. The group also carried out the organization of SDE2010 and SDE2012.



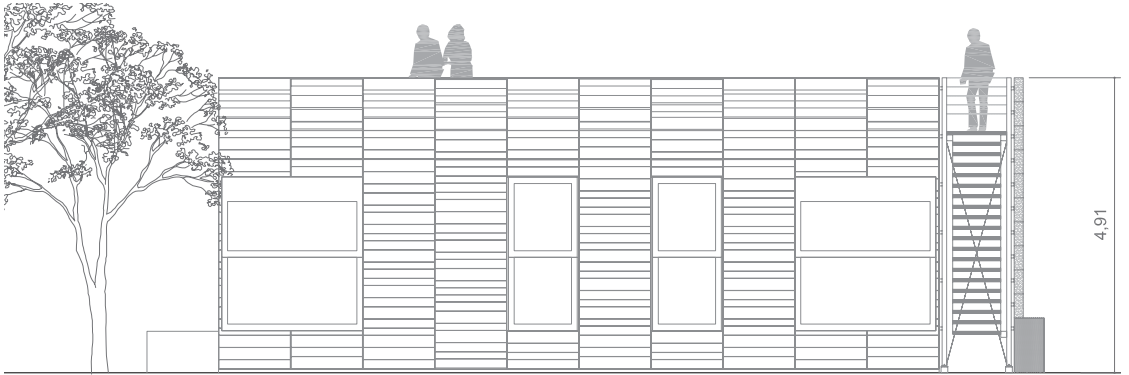

South site elevation

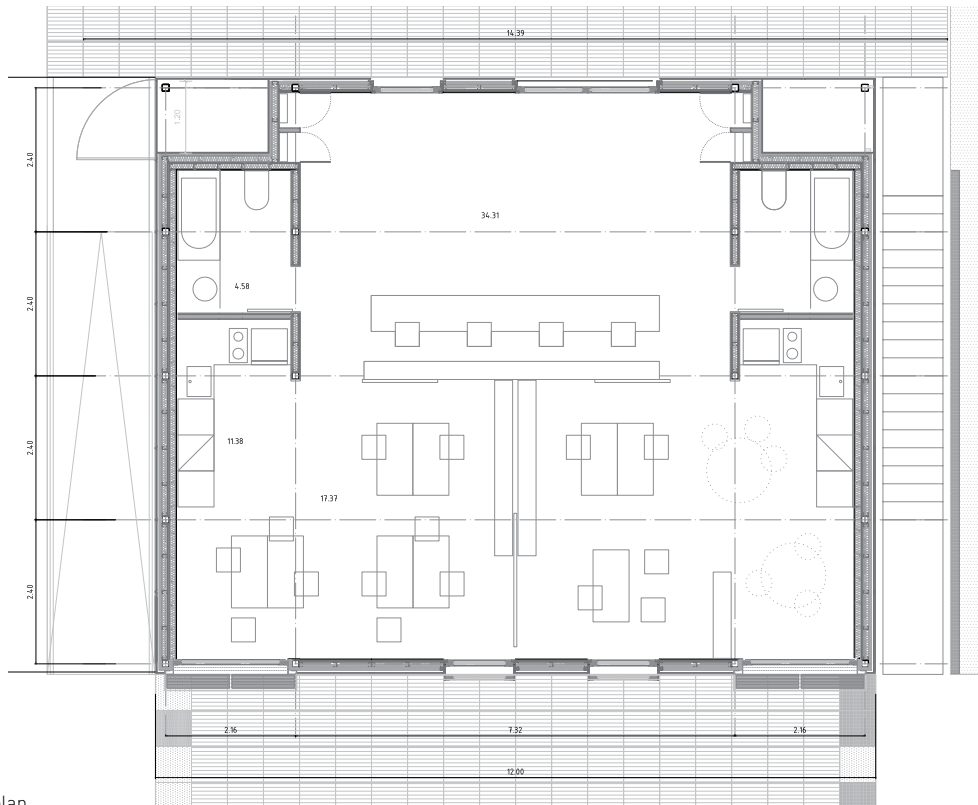

Floor plan

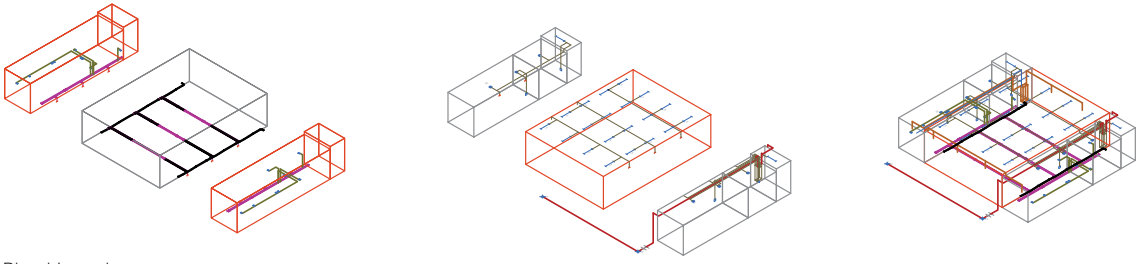

Plumbing scheme

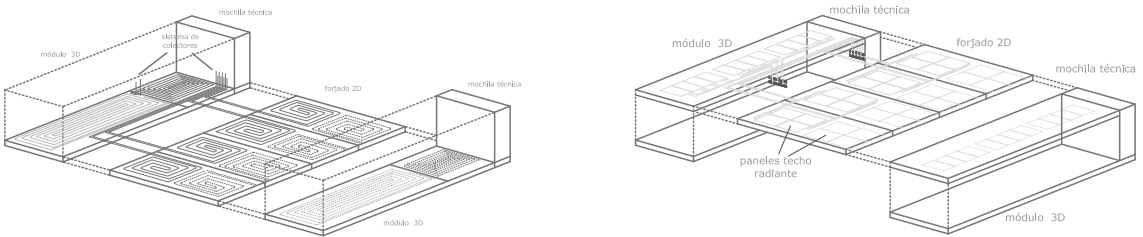

Heating and cooling scheme

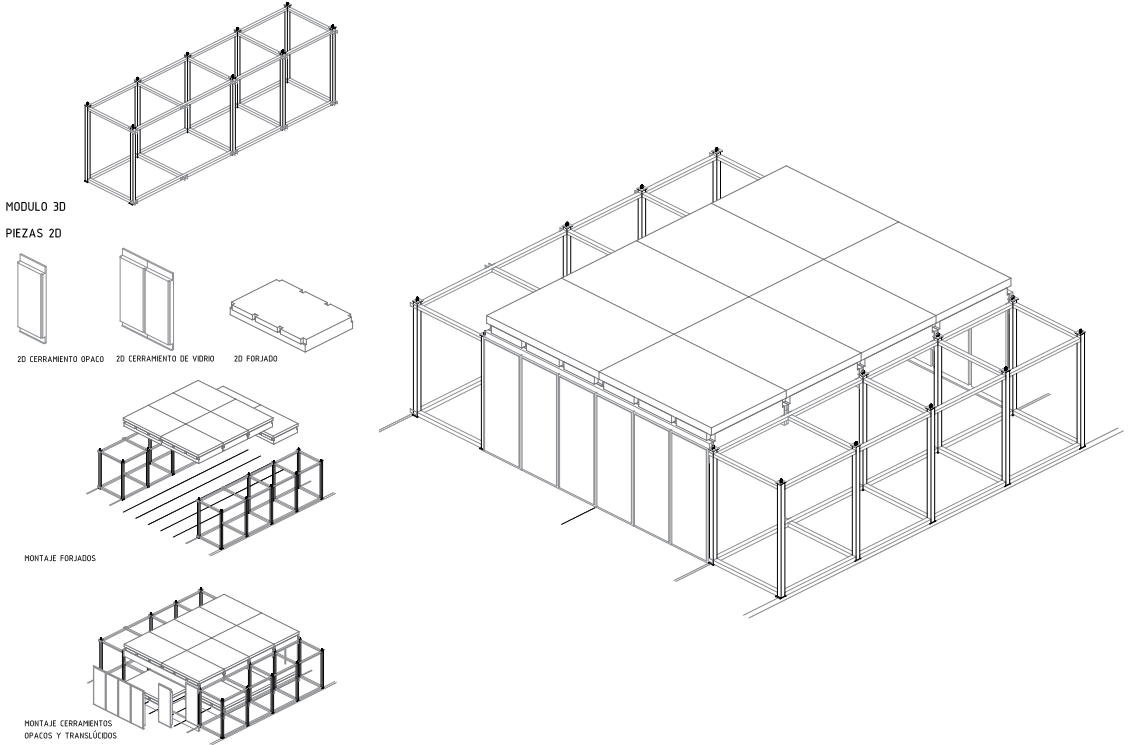

Envelope assembly process

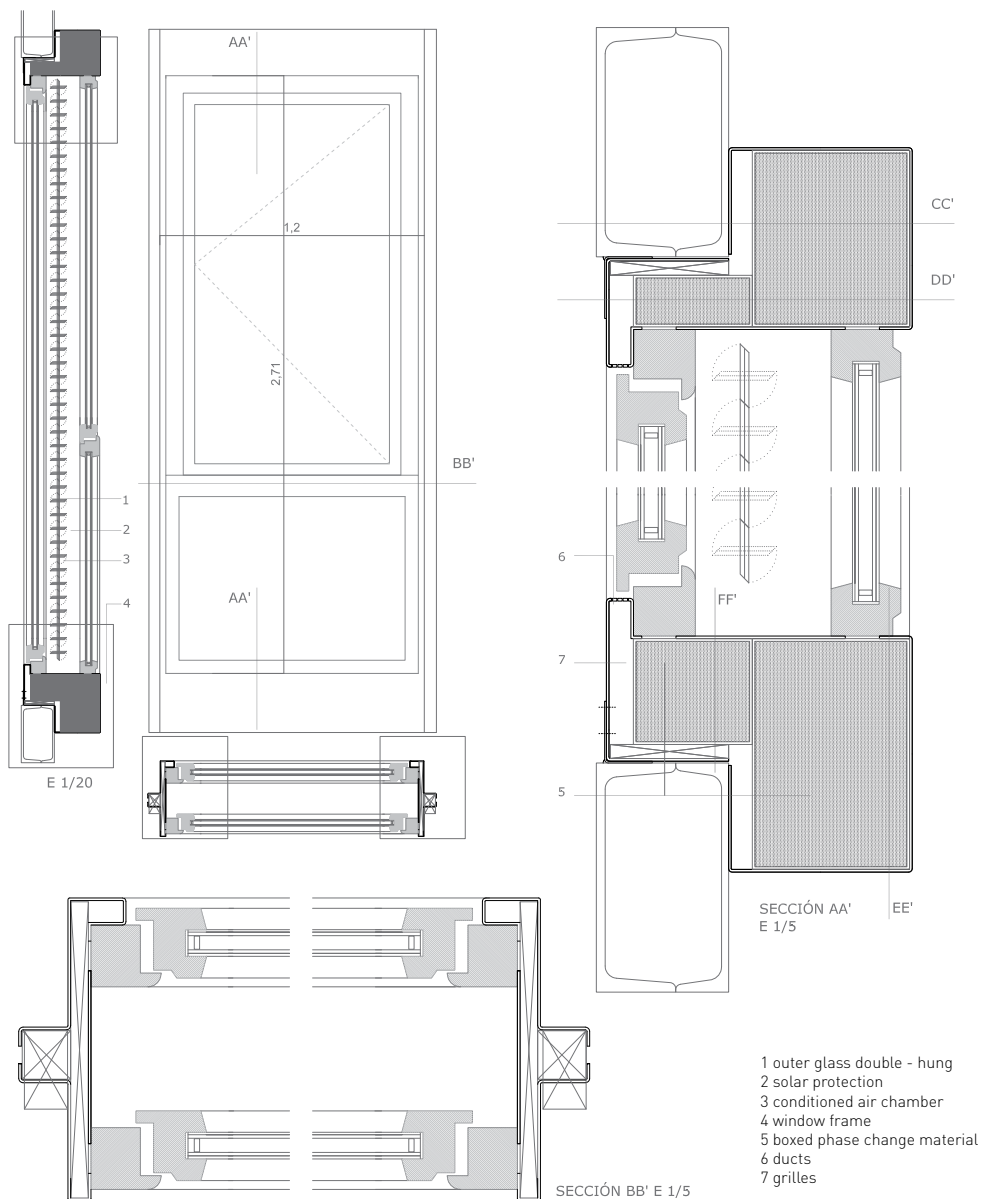

Detail of window

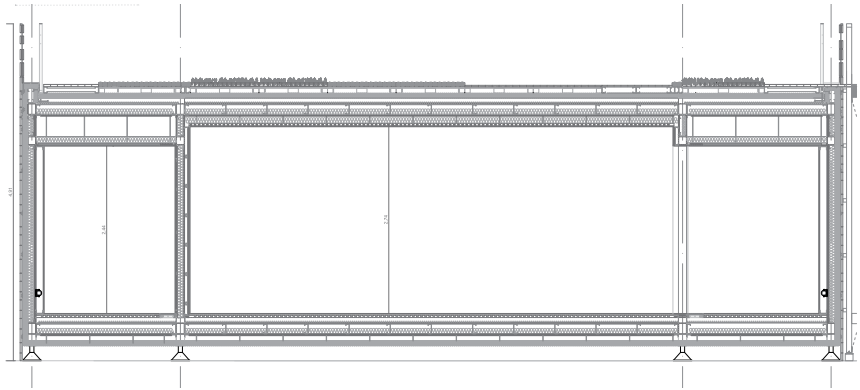

Longitudinal section

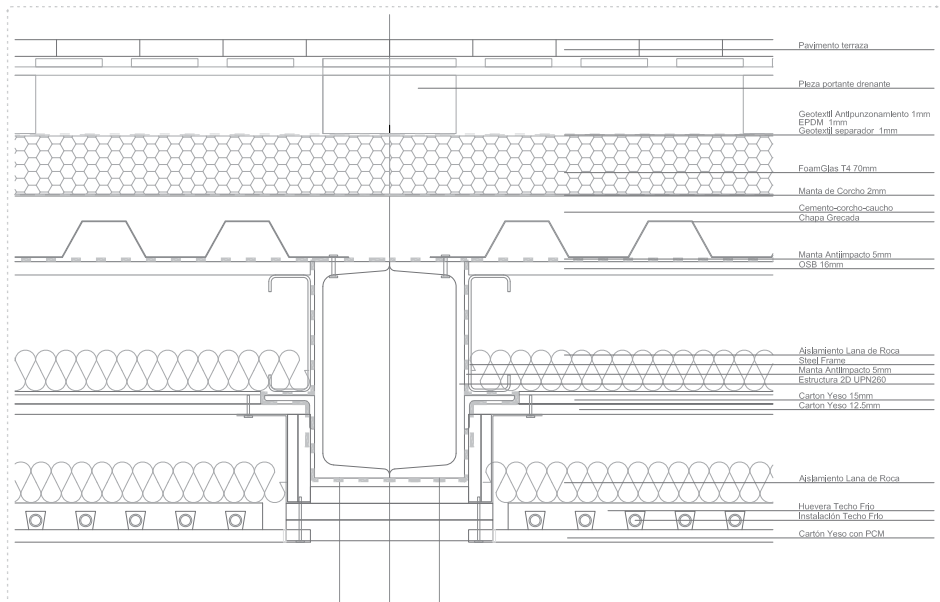
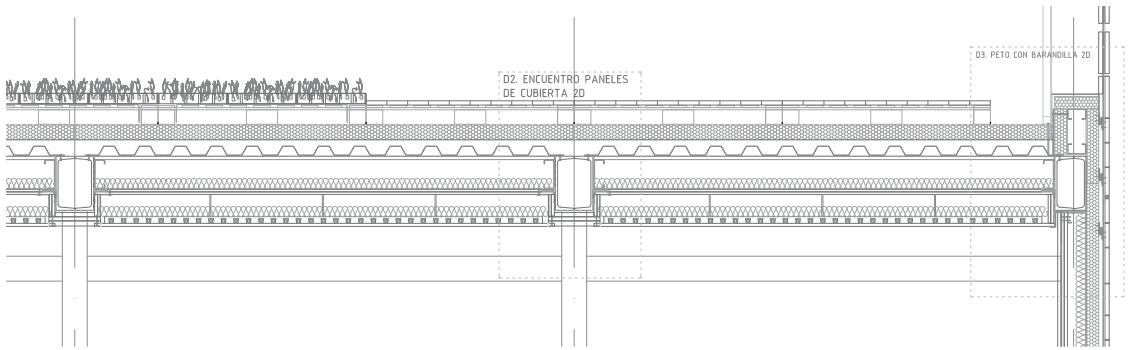

Details of modular green roof with cistern

TECHNICAL DATA OF THE HOUSE

Project name:
SDE 10

Construction area:
117,20m²

Conditioned area:
100,53m²

Conditioned Volume:
262,6m³

ENERGY BALANCE

Estimated energy balance:

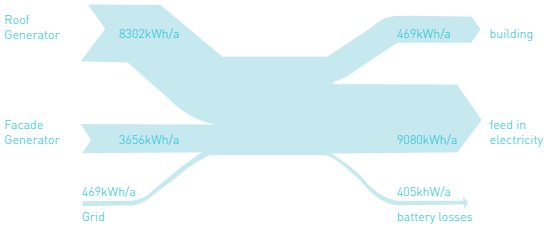

ROFF + FACADE:
12063 kWh/a
GRID:
497 kWh/a
3897 kWh/a bulding
8276 kWh/a feed in electricity
387 kWh/a battery losses

Estimated CO₂ emissions:
These modules generate electricity with no air emissions, no waste production, and no water use.

Estimated energy production:
12.560 kWh/a

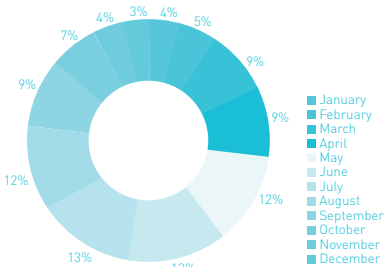

Information provided by the university

Photovoltaic system:
Total installed PV power (kW)::
9.1 kW

Types of PV Modules:
Roof: 130 high-performance modules with "CdTe" Cadmium Telluride.

ENERGY CONSUMPTION

Estimated energy consumption:
3897 kWh/a

Estimated electrical consumption:
38,76 kWh/ m²a

Characterization of energy use:
standard conditions 3897 kWh/a

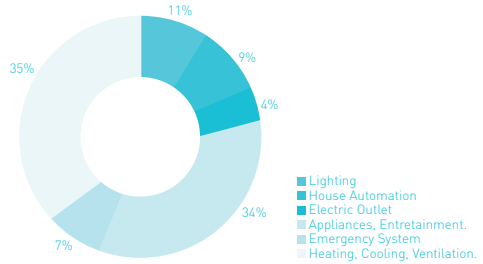

CONSTRUCTION ENVELOPE

Insulation types (type and thickness):
Fiberglass insulation , thickness 80 mm.

Constructive Systems thermal transmittance characterized by item e.g. floor, ceiling, façade):
Façade 0,38 W/m2K
Floor 0,30 W/m2K
Ceiling 0,30 W/m2K

COSTS

Construction Cost:
350.000 €

Industrialized Estimate Cost:
250.000 €

Credits

members of the SDEurope 2010 teams



CREDITS

Final Ranking

01. LUMENHAUS Virginia Polytechnic Institute & State University, United States of America
02. IKAROS_BAVARIA, University of Applied Sciences Rosenheim, Germany
03. STUTTGART TEAM, Hochschule für Technik Stuttgart, Germany
04. ARMADILLO BOX, Ecole Nationale Supérieure d'architecture de Grenoble, France
05. LUUKKU, Helsinki University of Technology, Finland
06. TEAM WUPPERTAL, Bergische Universität Wuppertal, Germany
07. NAPEVOMO HOUSE, Arts et Métiers Paris Tech, France
08. RE FOCUS, University of Florida, United States of America
09. SMLHOUSE, Universidad CEU Cardenal Herrera, Spain
10. LIVING EQUIA, Fachhochschule für Technik und Wirtschaft Berlin, Germany
11. BAMBOO HOUSE, Tongji, China
12. SOLARKIT, Universidad de Sevilla, Spain
13. LOW3, Universidad Politécnica de Cataluña, Spain
14. LA ENVOLVENTE DEL URCOMANTE, Universidad de Valladolid, Spain
15. NOTTINGHAM HOUSE, University of Nottingham, United Kingdom
16. SUNFLOWER, Tianjin University, China
17. FABLABHOUSE, Instituto de Arquitectura Avanzada de Cataluña, Spain



VIRGINIA POLYTECHNIC INSTITUTE & STATE UNIVERSITY

Final Location: (Currently) Plano, Illinois. Displayed alongside Mies Van der Rohe's Farnsworth house for Spring/Summer 2011 exhibition.

Faculty Members: Joseph Wheeler (Lead Project Coordinator, School of Architecture + Design), Robert Dunay (Director, Center for Design Research, School of Architecture + Design), Robert Schubert (Associate Dean for Research, College of Architecture + Urban Studies), *Design Responsible: Architecture:* David Clark, Alden Haley, Corey McCalla, Allison Ransom, John Black, Casey Reeve, Christian Truitt, Osam Osawa, Jonathan Grinham, Chris Taylor, Matthew Vibberts, Florence Graham, Travis Rookstool, Megan Sunderman. *Electrical System:* Roddy DeHart, Paul Gherardi, Richard Gilker, Kenny Johnson, Damion Logan, Justin Reyes, Josh Schaefer, John Shields, Danny Slover, Zack Zaremski. *Mechanical System:* Bridget Beurhle, Andrew Camardella, Robert Decarolis, Tony Fuchs, Curtis Manson, Matt McDaniel, Jonathan Metzman, Kevin Smith, Dewey Spangler, Bill Stewart,

Brendan Wayman. **Team Members:** *Student Leaders:* Alden Haley (Architecture), Corey McCall (Architecture), David Clar (Architecture), *Communications Team:* Stacy Adamson, Christine Burke, Lauren Castoro, Marissa Ferrara, Jen Neuville, Mike Payne, Dawn Roseberry, Matt Shuba, Kristin Washco, *Landscape Architecture:* Josh Franklin, Joseph Paredes, Christopher Ritzcovan, Allison Scott, Autumn Visconti, *Computer Sciences Team:* Ji-Sun Kim, Kenny Neal, Peter Radics, Patrick Sheridan, Mike Sutjipto, *Building Construction:* Mojtaba Taiebat, Will Cook, Safety Team: Irene John, Kara Vonder Reith

Extended Team Members: Corey Akers, Naif Altahlaw, Evan Arbogast, Meredith Baber, Zachary Bacon, Florence Graham, Michael Gultneh, Lindsey Jones, Gabriel Oliver, Kevin Schafe, Derek Belcher, Chelsea Berg, Margy Bozicevich, Jacob Bruch, Ian Buchanan, Justin Burnett, Kyle Butta, Jerry Case, Ryan Chamberlain, Jacob Chance, Kongkun Charoenvisal, George Cincala, Lauren Cline, Kyle Cooper, Clay Copeland, David Cotter, Anton Davelstein, Nicholas Denney, Peter Dunne, Drew Dunsten, Sujit Ekka, Vidya Gowda, Jenn Hare, Liz Haro, Kent Hipp, Wiley Horn, Shamim Javed, Kevin Jones, Jamal K. A., Danny King, Nathan King, Moly Malby, Luis Mantilla, John May, Nathan Melenbrink, Alexandra Militano, Bryan Murray, Peter Nettelbeck,

Alicia Nolden, Timothy Owen, Tofan Rafati, Rehanna Rojiani, Jon Runge, Dan Sargent, Paykon Sarmadi, Beth Sasso, Jeff Stolz, Diana Sullivan, Mike Sutjipto, Stephen Talley, Zach Taylor, Railesha Tiwari, Paul Toler, Ben Turpin, Tanner Versage, Caroline Wallace, Greg Wilds, Andrew Williams, Nick Wilson, Logan Yengst, Mellissa Lauer.

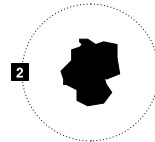

UNIVERSITY OF APPLIED SCIENCES ROSENHEIM

Final Location: Rosenheim.

Faculty Members: *Representative Professors:* Prof. Heinrich Köster, Oliver Heller, Kanzler (Regierungs Direktor), Prof. Mathias Wambsgans (Vicepresident for research and development), Prof. Dr. Stefanie Winter (Vicepresident for studies), Marcus Wehner (Master Engineer), Jan Peters (Dipl. Ing.), *Professors:* Dr. Gerd Beneken, Werner Braazt, Jürgen Buchner, Regine Falk, Dr. Harald Krause, Dr. Franz Feldmeier, Dr. Ulrike Förschler, Dr. Michael Krödel, Martin Lepsky, Dr. Franz Feldmeier. **Team Members:** Sylvie Altner, Benedikt Auer, Simon Barth, Johannes Bayer, Michaela Becker, Ferdinand Beljung, Thilo Bellingner, Stefanie

Berger, Stefan Bertagnolli, Alexandra Biederer, Josef Brinkmann, Johannes Donaubauer, Constantin Ebel, Phillip Eigl, Nico Engmann, Anja Epp, Miriam Felkel, Andreas Fessler, Stefan Finkelke, Sebastian Frass, Stefan Fronauer, Max Fronhöfer, Sebastian Füngener, Kathrin Gansinger, Benedikt Gassner, Phillip Groß, Paul Haacke, Mona Hain, Christoph Handwerker, Katrin Hartl, Gitte Henning, Björn Henseler, Daniel Henzold, Alexandra Herrmann, Angelika Hess, Michael Huber, Leonardo Ibacache, Mario Karl, Tobias Katzenberger, Vera Kießling, Tarek Kilani, Siad Kilani, Daniel Klaus, Michael Kolb, Carolin Köppel, Anton Koslow, Julian Krafft, Andrea Kraus, Jonas Krol, Daniel Kurzius, Johannes Maderspracher, Sara Miethe, Sebastian Mortimer, Markus Müller, Markus Neuburg, Christine Palm, Malte Pannecke, Oliver Pausch, Sebastian Preißler, Dominik Reif, Andreas Rudolph, Jonas Schneider, Adrian Schwarz, Johanna Seelhorst, Robert Spang, Björn Stankowitz, Anna Storm, Christian Syndicus, Hans-Martin Tröbs, Philipp Trojandt, Martina Wagner, Sebastian Wassermann, Barbara Wehle, Sascha Weidlich, Sindy Wember, Roxana Wilytsch.

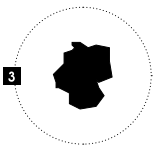

HOCHSCHULE FÜR TECHNIK STUTTGART

Final Location: Stuttgart.

Faculty Members: *Project Management and Development:* Jan Cremers (Prof. Dr. Eng. Architect), Sebastian Fiedler (Dipl.-Eng. Architect), **Team Members:** Design process (Total): Michael Bauz, Dalet Bodan, Simon Bütgenbach, Saskia Bulut, Maximilian Martin, Nalan Okumus, Nansi Palla, Claudia Röttinger, Jens Rossenauer, Sebastian Schmidt, Thilo Sprenger, Sonya Unrch, Daniel Walter, Matthias Wurst, Design process (Single Issues):

Elena Bagaeva, Mark Fandrich, Christiane Feil, Simone Ilder, Alen Lorenz, Micha Schneider, Construction: Ante Bosnjak, Jonas Frammelsberger, Jasmin Janiak, Pierre Keller, Matthias Klempf, Matthias Kraiss, Flavius Panic, Franziska Schall, Heiko Scheller, Andreas Schmid, Tim Schmitt, Kerstin Sieber, Winfried Speth, Christina Steil, Florian Steinlechner. **Project Staff:** Jürgen Aldinger (Dipl.-Eng; Furniture), Silvio Barta (Dipl.-Eng; Translations, Web Design), Siegfried Baumgartner (Dipl. -Eng. Building control, PV, Electrical Engineer), Romano Bianchi (Carpenter), Markus Blinder (Dipl. -Eng. building physics, energy technology), Antoine Dalibard (Dipl. -Eng. Energy supply, engineering and simulation), Andreas Drechsler (Dipl. -Eng. Room acoustics and sound insulation), Ole Fach (M.A.; co-construction management, Stuttgart, Madrid), Heiner Gußmann (Carpenter), Dominik Hahne (M.A. Architect; co-construction management, Stuttgart), Ulrich Handfest (Fundraising), Heiner Hartmann (Prof. Dr.-Eng. Structural engineering.), Christiane Kloss (Dipl.-Eng. Fundraising), Annette Kunz-Engesser (M. Eng. Dipl.-Eng. architect, cost and schedule planning), Dennis Mattner (co-construction management, Stuttgart, Madrid), Domenico Robertazzi (Workshop Foreman), Phillip Spoun (Workshop Foreman), Albert Stöcker (construction management, Stuttgart, Madrid) **Consultants:** Andreas Beck (Prof. Dr.), Ursula Eicker (Prof. Dr.), Klaus-Peter Goebel (Prof.), Christine Kappei (Prof.), Harald Roser (Prof.), Stefan Zimmermann (Prof.)

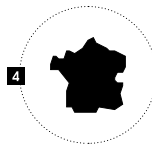

ÉCOLE NATIONALE SUPÉRIEURE D'ARCHITECTURE DE GRENOBLE

Final Location: Grenoble.

Faculty Members: *Faculty Advisor:*

Pascal Rollet (Professor, Architect), *Project Manager:* Nicolas Dubus (Assistant Professor Architect), *Construction Manager:* Nicolas Dubus (Assistant Professor, Architect), *Project Architect:* Pascal Rollet (Professor, Architect), *Project Engineer:* Olivier Baverel (Assistant Professor Engineer), *Structural Engineer:* Jacques Anglande (Engineer), *Primary Student Contact:* Basile Cloquet (Mathilde Chamodot Architects, PHD students), *Public Relations:* Vincent Jaques Le Seigneur (General secretary of INES), *Instrumentation:* Jean-Christophe Fluhr, Laurent Tochon (Polytech-Savoie students), Cost Estimator: Sebastien Freitas, (Architect, teaching assistant). **Team Members:** *Grenoble University:* Collin Michel, Sebastian Freitas, Anaïde de Pachtere, Justine Dufour, Fabrice Tessier, Laurent Arnaud, Sylvie Wheeler, Olivier Baverel, Pascal Gantet, Nicolas Dubus, Vincent Jacques le Seigneur, Jean Christophe Fluhr, Thomas Jusseime, Manuel Henry, Fabrice Baumann, Nessler Fellmann, Paul Leandri, Patrice Doat, Nathalie Doat, Rosseau Duborg, Nathalie Mounoussamy, Marc Desplanches, Sylvia Bardos, Alain Romeas, Andrée Roméas, Estelle Bonhomme, Maire-Laure Chatelain *Team Crew:* Simon Thibaut Cruyenninck, Ogiso Hiroko, Bernard Gimenez, Naoki Kusumi, Yuki Kusumi, Tomoumi Suzuki, Joao Casanova, François Rozay, Ferry Christelle, Palomo Team, Christophe Darlot, Paula Casanova, Kinua Mauyama, Bernard Ribière Decathlete: Mathieu Biberon, Javier Herrero Rodrigo, Elsa Pillon, Christophe de Tricaud, Alexandre Vial-Tissot, Maud Laronze, Valentine Vaupré, Pauline Suhr, Jean-Luc Beauseigle, Benjamin Camerino, Charlotte Cany, Lucie Cretin, Sarah Kerdraon, Anthony Sintes, Jérémie Henry, David Reymond, Romain Berdiel, Camillo Hiche Schwarzhaupt, Elvire Leylavergne, Ivan Mazel, Samuel Nemoz, Marine Potonnier, Vivian Vial, Léa Viricel, Quentin Chansavang, Guillaume Pradelle, Josselin Guillo, Olivier des Rieux, Jeanne Dé-

nier, Odette Fuentes Urrutia, Luc Lacroix, Rollet Anais, Martin Dorothee, Maxime Bonnevie, Cédric Gaillard, Hugo Gasnier, Grégory Landraud, Marie Roméas, Laurent Tochon, Aurélien Messa, Samuel Chapuis-Breyton, Mariana Gomez Bentos, Marc Parlange, Thienneau Lauriane, Boris Bosdevigie, Faculty Advisor: Pascal Rollet.& Danielle Ruffin, Benjamine Jeunehomme, Joelle Ceroni, Vincent Delpy.



HELSINKI UNIVERSITY OF TECHNOLOGY

Final Location: Helsinki.

Faculty Members: *Faculty Advisor:* Pekka Heikkinen, *Construction Manager:* Mikko Alekski Merz **Team Members:** Luka Jonjic, Yrsa Cronhjort, Mikko Teerenhovi, Ting Ting Dong Martti Paakkinen Team Crew: Pauli Åberg, Heikki Mustikkamaa, Reino Pitkänen, Juha Wikman, Erik Tapani Helenius, Invitado: Hanna Korsberg Decathlete: Liisa Jokinen, Harri Nuora, Jaakko-Parkkonen, Ulla Weckman, Ransu Helenius, Laura Mattila & Sarlota Narjus, Anna Herlin, Mikko Raikonen, Antti Juhan Herlin, Mikko Raikonen, Tiina Herlin.

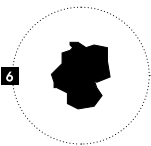

BERGISCHE UNIVERSITÄT WUPPERTAL

Final Location: Wuppertal.

Faculty Members: *Chair in building construction and designing:* Anett-Maud Joppien (Prof. Dipl.-Ing. M.Arch.), Martin Hochrein (Dipl.-Ing.) *Chair in environmental building design:* Karsten Voss (Prof. Dr.-Ing.), Soara Bernard (M.Sc. Dipl.-Ing.) *Collaboration with:* Department for Economics – Schum-

peter School of Business and Economics Chair in Foundation of an enterprise and Economic Development, Christiane Blank (M.BA), Holger Berg (Dipl.-Ök). **Team Members:** Cristina Amaral (Architecture, Master) *Concept, planning of execution facade, Communication, Sponsoring, Construction and Competition*, Simon Arbach (Mechanical Engineering RWTH Aachen) *House automatization, Monitoring, Construction and Competition*, Dominik Bamberger (Civil Engineering) *Construction management, Logistics, Construction and Competition*, Sarah Baust (B.Sc. Architecture) *Planning of execution, planning of Construction, Construction and Competition*, Rebecca Bechem (Architecture, Master) *Building climate control and energy, planning of execution curtain and facade, Construction and Competition*, Jörn Gertenbach (Architecture, Bachelor) *Planning of execution interior, Construction and Competition*, Dennis Hagen (Architecture Master), *Building climate control and energy, Communication, Construction and Competition*, Armin Kartal (Architecture, Bachelor) *Concept, planning of execution, Construction and Competition*, Birgit Kasten (Civil Engineering) *Health and Safety, Construction and Competition*, Oliver Kling (Architecture, Bachelor) *Planning of execution, Construction and Competition*, Seyfullah Köse (Media-design) *Communication, Layout, Film, Competition*, Miriana Kostova (Architecture, Bachelor) *Planning of execution interior, Acquisition, Construction and Competition*, Damian Kwoczala (Architecture, Bachelor) *Modeling, Construction and Competition*, Jan Liffers (Architecture, Bachelor) *Planning of execution interior, Construction and Competition*, Julius Otto (Architecture, Master) *Building climate control and energy, planning of light concept, Construction and Competition*, Melina Schulz (Architecture Master) *Building climate control and energy, life cycle analysis, Construction and Competition*, Daniela Steinhaus (Architecture,

Master) *Building climate control and energy, Construction and Competition*, Bettina Titz (Architecture, Master) *Concept, planning of execution, Building climate control and energy, planning of kitchen concept, Construction and Competition*, Bernd Wroblewski (Architecture, Master) *Concept, planning of execution, Construction and Competition*. **Specific Areas:** Anna Bamberger, *Theology Catering during competition*, Daniel Bechem, *Economics Construction*, Ariane Dehghan M.Sc. *Architecture, Planning of execution, Competition*, Carolin Herrmann, Robin Höke, Daniela Nählen, *Communication design Exhibition concept and Competition*, Philipp Kompch, *Architecture Visualization*, Rebecca Sehy, *Economics Public relations*, Gordan Stanic, Sebastian Stenzel, *Civil Engineering Measurement and Construction*, Florian Siegmund, *Economics Organization*, Max Schilling, *Civil Engineering Planning of the kitchen, Construction and Competition*, Kathrin Poethke, *Economics Market Viability, Construction and Competition*, Benedikt Völkel B. Sc, *Architecture Visualization, Film/Animation*, Arno von Weidenfeld, *Civil Engineering Logistics, Construction and Competition*, Tiana Wiebusch, *Economics Public Relations*, Anja Wolking, *Economics Organisation*. **Collaboration:** Ruth Knoth (Dipl.-Ing. (FH) Architect), Manuel Loesaus (M.Sc. Dipl.-Ing. Architect), *Planning and Building inspection*, Cecilia Torres Rodríguez (Dipl.-Ing.), *PR and Communication*, Hedwig Wiedemann-Tokarz (Dipl.-Ing. Architect), *Planning and project management*, Michael Döring (Dipl.-Ing. Architect), *Planning*, Sven Schulz (Dipl.-Des), *Planning of interior concept*, Oliver Hans (M.Sc. Dipl.-Ing), Eike Musall (M.Sc.), *Support on site*.

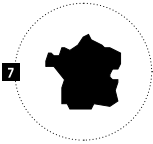

ARTS ET MÉTIERS PARIS TECH

Final Location: Bordeaux, France.

Faculty Members: Denis Bruneau (Teacher-researcher in Arts et Métiers ParisTech), Philippe Lagiere (Scientific director in Nobatek). *Design Responsible:* Architecture: Gonzalo Rodriguez (Architect), Benoit Beaupty (Designer), Stéphanie Armand (Last year student in Arts et Métiers ParisTech), Julien Bodennec (Last year student in Arts et Métiers ParisTech), *Structure:* Mathieu Condamin (Last year student in Arts et Métiers ParisTech), Emmanuel Marion (Last year student in Arts et Métiers ParisTech), *Electrical System:* Alexandre Renaudie (Second year student in Arts et Métiers ParisTech), Joël Duprat (Second year student in Arts et Métiers ParisTech), *Photovoltaic System:* Benjamin Andre (Last year student in Arts et Métiers ParisTech), Erwan Etienne (Last year student in Arts et Métiers ParisTech), *Mechanical System:* Florent Dubois (Last year student in Arts et Métiers ParisTech), Adrien Lizinczyk (Last year student in Arts et Métiers ParisTech). **Team Members:** Last year student in Arts et Métiers ParisTech: Gaetan Bourgogne, Julien Grimault, Arthur Davodeau, Second year student in Arts et Métiers ParisTech: Zineb Antar, Antoine Baron, David Gaspard, Guillaume Bonnet, Simon Crampe, Alexis de Gall, Mikael Gros, Valérie Ho Hio Hen, Nicolas Kerguignas, Pierre Lavie-Cambot, Charline Malandain, Alexandre Paquet. **Industrial Partners:** The project team gathers companies with higher education and research institutions for the design, construction and monitoring of the solar house prototype Napevomo. Leading companies: Aldes/Exosun/Kerco/Menuiserie Goisnard Frères/Sun H2O, Architecture, interior design and furniture: Atelier Bois Production/Les Ateliers

de Guyenne/Bon Sens/IUT Génie Civil/Lycée des Métiers de Blanquefort/MC Décoration/Mobilier Goisnard Frères, *Timber construction and envelope:* ABOVE/ Batiécoco/Beynel/Blum/Fermacell/Foussier/Grès de Gascogne/Lamecol/Ouateco Tremco Illbruck/Pavatex Energy systems: Alliantz/Moeller/SunPower, *Electricity, domotic and lighting:* Laboratoire CERE/Domotic Xperience/Icelec/ Luxener Vegetalization: Casa Verde/Epiphyte/O'fertil/Vertige, *Natural water treatment and storage:* Lombritek/Reserveo, *Virtual visit, communication advisory, and video production:* Keonys/SoGreen Communication/VSave Visual identity and graphic design: nicomnico.

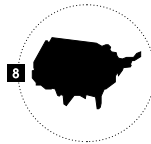

UNIVERSITY OF FLORIDA

Final Location: University of Florida, Gainesville, FL.

Faculty Members: Mark McGlothlin, Robert Ries, Jim Sullivan, Maruja Torres, Bradley Walters, Russell Walters. *Design Responsible:* Architecture: Chris Sorce, Clay Anderson, David To, *Structure:* Jason Parker, *Electrical System:* Jeff Humpal, *Photovoltaic System:* Kevin Priest, *Mechanical System:* Alex Palomino. **Team Members:** Aaron Hynds, Alex Palomino, Alex Rhunau, Amanda Young, Amy Guidos, Amy Long, Andrew Herbert, Brian Kim, Brooks Ballard, Chris Anderson, Chris Chappell, Chris Sorce, Clay Anderson, Crystal Torres, Dale Freel, Darren Hargrove, David Cowan, David To, David Wasserman, Dereck Winning, Erika Zayas, Erin White, Geoff Miller, Ian Trunk, Isaac Church, Isabel Quintana, Jacky Ramos, Jacob Beebe, Jake Landreneau, Janette Holloway, Jason Parker, Jeff Humpal, Jessica Tomaselli, Joanna Brighton, John Atkinson, Jordan Wise, Kathryn Watson, Katie Huber, Kevin Priest, Laura Ettetdgui,



UNIVERSIDAD CEU CARDENAL HERRERA

Final Location: Escuela Superior de Enseñanzas Técnicas Universidad CEU Cardenal Herrera, Alfara del Patriarca, Valencia.

Faculty Members: Fernando Sánchez López, Guillermo Mocholí Ferrándiz, Andrés Ros Campos, Pedro Verdejo, Alfonso Díaz Segura, Manuel Martínez Córcoles, Elisa Marco, Víctor García Peñas, Nicolás Montés Sánchez, Luís Doménech Ballester, Jordi Renau Martínez, Borja García, Aurelio Pons. *Team Officers:* Architecture: Guillermo Mocholí, *Structure and construction:* Alfonso Díaz Segura, Pedro Verdejo, Manuel Martínez Córcoles, *Electrical systems and home automation systems:* Jordi Renau Martínez, Nicolás Montés Sánchez PV Systems: Jordi Renau Martínez, Víctor García Peñas, Luís Doménech Ballester, Nicolás Montés Sánchez *Mechanical systems:* Víctor García Peñas, Luis Doménech Ballester, *Communication and marketing:* Elisa Marco, Aurelio Pons. **Team Members:** Architecture: Alberto Mocholí Fernández, Ana González Rovira, Antonio Orero Tarazaga, Bernat Ferrer Pons, David Carceller Capella, Davinia Catalá Carrió, Estefanía Pérez Gómez, Ferrán Gregori Climent, Francisco Gordo Martín, Gonzalo Aragón Olalla, Irene Lledó Martínez, Jesús Alfaro García, Jesús Jiménez Mateo, Jesús

Madrid Quesada, José Gambín Lorenzo, José García Alamar, José Javier Gómez Díaz, José María Serra Soriano, Juan Antonio Araque Marín, Juan Farina Cuevas, Juan Luís Miravalls Rubio, Juan Pablo Tur Guillém, Laura Ros Gorrochategui, Lorena Quiles Escudero, Loreto Navarro Arcos, Manuel Calleja Molina, María Antón Barco, M^a Pilar Amigo Doménech, M^a Pilar Barambio Martín, M^a Pilar Arnal Alonso, Pedro Terrades Zorrilla, Santiago Escobedo Soto, Sergio Pérez Llompарт, Teresa Blasco Vicente, Víctor Masip Gimeno, José Vicente Navarro Díaz, Jesús Madrid Quesada, José M^a Serra Soriano, Sergio Pérez Llompарт, Antonio Orero Tarazaga, José Javier Gómez Díaz, David Carceller Capella, Teresa Blasco Vicente, Loreto Navarro Arcos, Pedro Terrades Zorrilla, José García Alamar, Bernat Ferrer Pons, Esteban Belmonte Zamora, Gloria Ituren Girona, Carlos de Inés Aragó, Carla Casanova Pardo, Maribel Villar Abril, Jesús Jiménez Mateo, Oreto Pina Gómez, Lorena Quiles Escudero, Santiago Escobedo Soto, Ana González Rovira, Pilar Amigó Doménech, M^a Isabel Gonzalvo Campos, Luisa Hernández Martín. *Systems*: José Vicente Navarro Díaz, Angelo Massa, Carla Casanova Pardo, Carlos de Inés Aragó, Clara Lidia Fuentes Magraner, Esteban Belmonte Zamora, Gloria Ituren Girona, Javier Ibáñez Martínez, José Alabau Casaña, M^a Elena Genovés Marchuet, M^a Isabel Villar Abril, M^a Pilar Asensio Herrero, Marta Lara García, Oreto Pina Gómez, Patricia Sanz Nuez, Susana Peñalver Mir IT: José Miguel Casaña, Juan Antonio Ventura, Pedro Saiz Banaclocha, Rafael Báguena Girbes, Saimon Matéu Bello, Vicente Presencia Gresa. *Design*: Alberto Silla Morales, Aleix V. Sala Sanchis, Ana Navarro Barber, Analía Blanco, Antonio Benlloch Garrido, Borja Martos Medina, Carles Rodrigo Monzón, Carlos Martín Valls, Clara Blasco López, Daniel Salvador Esteve, Iker Prieto Espuña, Inmaculada Fenech Chordá, Jorge Juan Prieto Campos, Juan Soriano Blanco, Laura

Blasco Ortí, Lucía Muñoz Vázquez, Manuel Díaz Redondo, María Navarro Diego, Marta Guerrero Coloma, Noelia Ruiz Teruel, Raúl Blanco García, Sara Gabarda Alegre, Sara Pascual de Frutos, Silvia Córdoba Pérez. *Communication*: Mayte Pascual Pérez (coordinator), Beatriz Sevillano Álvarez (coordinator), María Isabel Gonzalvo Campos, Luisa Hernández Martín, Juan J. Campos Martín, Mamen Monzó Gallego, Gisela Torrente Román, Raquel Villarroya Casinos, Kike Benedito Ballester, Susana Martín Regidor, Benjamín Serra Bosch, Leyre García Alcalá, Inma Barona, Rocío Mendoza, Miriam González Pardo, Luiza Arcalean, Silvia Guardiola de Fez, María Vila Prada, Patricia Gallardo Verdú, Mar Navarro Gutiérrez, Tamara García Raga Decathletes: José Vicente Navarro Díaz, Jesús Madrid Quesada, José M^a Serra Soriano, Sergio Pérez Llompарт, Antonio Orero Tarazaga, José Javier Gómez Díaz, David Carceller Capella, Teresa Blasco Vicente, Loreto Navarro Arcos, Pedro Terrades Zorrilla, José García Alamar, Bernat Ferrer Pons, Esteban Belmonte Zamora, Gloria Ituren Girona, Carlos de Inés Aragó, Carla Casanova Pardo, Maribel Villar Abril, Jesús Jiménez Mateo, Oreto Pina Gómez, Lorena Quiles Escudero, Santiago Escobedo Soto, Ana González Rovira, Pilar Amigó Doménech, M^a Isabel Gonzalvo Campos, Luisa Hernández Martín.

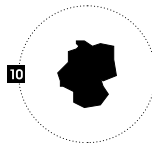

FACHHOCHSCHULE FÜR TECHNIK UND WIRTSCHAFT BERLIN

Final Location: Berlin.

Faculty Members: Professors: Dipl. Ing. Frank Arnold (HTW Berlin), Prof. Dr. Habil. Petra Bittrich (HTW Berlin), Prof. Dr. Ing. Hannelore Damm (HTW Berlin), Prof. Dr. Ing. Christoph Geynagel (UDK Berlin), Prof. Dr. Ing. Christoph Nytsch-Geusen (UDK Berlin),

Prof. Dr. Ing. Habil. Volker Quaschnig (HTW Berlin), Prof. Dr. Ing. Friedrich Sick (HTW Berlin) Prof. Dr. Jochen Twele (HTW Berlin), Anke Engel (HTW Berlin), Heidemarie Brümmer (HTW Berlin). **Team Members:** *Organization and Communication: Regenerative Energie:* Marcus Bui, Sebastian Dietz, Nora Exnere, Martin Hofmann, Michael Krapf, Michael Richter Matthias Schwärzle, Simon Winiger *Architecture:* Christoph Hey, Linda Wortmann *Project Management:* Robert Quednau *Economics:* Arlett Ruhtz *Architecture and Structures: Architecture:* Florentine Dreier, Christoph Hey, Anja Neupert, Stefan Panier, Rico Schubert, Linda Wortmann. *Energy and electrical systems: Regenerative energie:* Marcus Bui, Sebastian Dietz, Nora Exner, Alex Carstens, David Düver, Matthieu Ebert, Maximilian Friese, Tim Grossmann, Hagen Hartmann, Martin Hofmann, Achim Kraft, Felix Liebe, Friedermann Leopold, Maik Matthus, Janis Jeanne Merkel, Niklas Netzel, Henning Opitz, Michael Richter, Simon Sutter, Christian Wagner, Simon Winiger *Technical Development:* Manuel B. Dhom, Thomas Dittmann *Mechatronik:* Felix Laug. *Project Management:* Robert Quednau & Dr. Ing Susanne Rexroth, Christian Hodgson.



TONGJI UNIVERSITY SHANGHAI

Final Location: Not Assembled.

Faculty Members: Hongwei Tan, Quian Feng. *Design Responsible: Architecture:* Zhongqi Yu. *Structure:* Tao Lu. *Electrical Systems:* Peng Li. *Photovoltaic Systems:* Xiang Wang, Qiang Li. *Mechanical Systems:* Dongwei Yu. **Team Members:** Zhonglai Ben, Shenghua Chu, Lizhen Wang, Weinan Ma, Fengxin Xi, Chen Li, Jiawei Wu, Wang Zhen, Chen Lin, Zeng Qun, Baocheng Luo, Xiangdong Chu, Sulong Cheng,

Jixin Zhong, Linhui Jin, Tao Lu, Hairong Tian, Zhengrong Fei, Yuanlong Liu, Tianping Xu, Xiaojun Zhang, Rong Zhou, Jianhui Zhou, Xiao Hui, Wang Xiang, Lei Jlang, Guo Xia, WeiWei Sun, Haitian Liu.



UNIVERSIDAD DE SEVILLA

Final Location: Not Assembled.

Faculty Members: Francisco Javier Terrados Cepeda. *Design responsible: Architecture:* Francisco Javier Terrados, José Miguel Tineo Sánchez, Rodrigo Morillo-Velarde Santos, *Structure:* José Antonio López Martínez, Francisco Javier Terrados Cepeda, *Electrical System:* Juan Emilio Ballesteros Zaldivar, Constantino García Sánchez, *Photovoltaic System:* Constantino García Sánchez, Eugenio Domínguez Amarillo, *Mechanical System:* Javier García López, Salvador Muñoz Muñoz.

Team Members: *Management Area:* Javier Terrados Cepeda (Project Principal), Antonio Guillén López (Project Manager), José Miguel Tineo Sánchez (General Coordinator), *Students:* Manuel Ogalla Larramendi, Jesús Suárez Caparrós *Architecture Area:* Javier Terrados Cepeda (Architecture Manager), *Architects:* José Miguel Tineo Sánchez, Rodrigo Morillo-Velarde Santos, *Collaborators:* Israel Moreno Torres, Margarita Calero Santiago, Luz Baco Castro, Juan Pérez Parras, *Students:* José Miguel Ternerero, Gil Carmen Muñoz Cauqui, Beatriz Osuna Ruiz, Adrian Auth *Construction Area:* José Antonio López Martínez (Construction Development Manager), Carmen Galán Marín (Construction Research Manager), *Collaborators:* Juan Carlos Camacho Vega, Javier Caro Domínguez, Reyes Caro Domínguez, Carmen Llatas Oliver, Antonio García Martínez, *Student:* David Villegas Cerrado, Isabel Pablo-Romero Carran-

za, Carmen Navarrete Elorduy, Cristina Rosa Roncero *Engineering Area:* Javier García López (Engineering Manager), Salvador Muñoz Muñoz (Deputy Engineering Manager), *Collaborators:* Juan Emilio Ballesteros Zaldivar, Samuel Domínguez Amarillo, Manuel Ordóñez Martín, *Students:* Ana María Gómez Gómez Juan Mora Gómez, Ignacio Márquez Martín *Photovoltaic Solar System Area:* Eugenio Domínguez Amarillo (Development Manager), José Ignacio León Galván (Research Manager), Constantino García Sánchez (Deputy Solar Manager), *Collaborators:* Isaac Gil Mera, Oliver Martínez Vitoriano, Daniel Morales Muñoz, David Rosales Acosta (student) *Comunication Area:* Sergio Fernández García (Comunication Manager), *Students:* María del Mar Gamero Sánchez, Nuria Rodríguez Ruiz, Francisco Ramos Ordóñez (Fashion Designer), *Estudio de Comunicación Martín Moreno & Altozano* (Plan Media), *Taller de Realidad Virtual* (Models), Fernando Donoso (Models) *Subject in Higher Technical School of Architecture of Seville* (students): Konstantino Tousidonis Rial, Blanca del Espino Hidalgo, Manuel Medina González, Rafael Rodero Mínguez, Lourdes Moreno Garrido, Antonio Quesada Ávalos, Sara Santamaría Cuevas, Daniel Díaz Regodón, Francisco Javier Pozas Robles, José Luis Castillo Ramos, Ana Correa Martín-Arroyo, Juan Manuel Infante Ruíz.

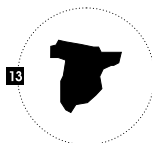

UNIVERSIDAD POLITÉCNICA DE CATALUNYA

Final Location: Campus ETSAV, Sant Cugat del Vallès, Barcelona.

Faculty Members: Torsten Masseck (Director / Project Manager), Monica Tarrega (Co-direction) *Collaboration:* Coque Claret, Dani Calatayud, Robert Brufau, Enrique Corbat, J.M. Nacen-

ta. *Design Responsible, Architecture:* Marc Diaz, Alejandro Ribas (LOW3), Torsten Masseck (UPC) *Structure:* Sergio Díaz (LOW3), Antoni Domènech i Albiach (OCTSA) *Electrical System:* Lorena Cardenas, Marianna Carminati (LOW3) Juan Gallosta Isern (JG Ingeniería) *Photovoltaic System:* Torsten Masseck (LOW3), Moises Martinez Felix (TFM Ingeniería) *Mechanical System:* Ludovica Rossi, Miguel Brand (LOW3), J.M Nacenta (UPC), Joan Cubedo (REHAU) **Team Members:** Marc Díaz, Manel Romero, Sergi Díaz, Isacio García, Ludovica Rossi, Aurora Suñol, Alejandro Ribas, Joan Encuentra, Oriol Troyano, Miguel Brand, Xavi Mallorqui, Martín Negri, Alba Romera, Georgina Casanova, Marianna Carminati, Lorena Cardenas, Humberto Carneiro, Glauca Pimentel, Virginia Carrasquer, Clara Ortiz, Renato Prandina, Marta Banach, Luis R. Borunda, Francesc Capdevila, Francisco Carballo, Bernat Colomé, Guillem Daviu, Aida El Kabbaj, Elisa Ferrando, Anna Homs, Aitor Iturralde, Simone Lorenzon, Andrei C. Mihalache, Jordi Mitjans, Natalia Pérez, Antoni Poch, Eduard Resina, Roc Serra, Adrià Vilajoana, Francisco Pérez, Matthew Earle, Chloe Georgiou, Elena Giannotti, Alice Melita, Rosella Longavita, Oscar Galeote.



UNIVERSIDAD DE VALLADOLID

Final Location: Escuela Técnica Superior de Arquitectura. Universidad de Valladolid. Valladolid, España.

Faculty Members: *Faculty Advisor:* Jesús Feijó, *Project Manager:* Alfonso Basterra, *Architecture:* Pedro Luis Gallego, *Construction:* M^a Soledad Camino, Félix Jové, *Structure:* Mariano Salazar, *Heating / cooling systems and installations:* Fernando Frechoso, Jaime Gómez *Costs and Security:* Luis De la Riva. *Design Responsible:* Héctor

Otero (Team leader), Beatriz Alcalde (Architecture Coordinator), Laura Casanova (Facades Responsible), Miguel Ángel García (Construction Coordinator), Tomas González (Coordinador Industrialización), Cesar Nieto (Global Studies Responsible), Pedro Retortillo (Engineering Coordinator), Andrés Iglesias (Electricity Responsible) Noel Manzano (Sustainability Responsible), Javier Hernández (Communication Coordinator), José Antonio Balmori (Security and Safety Coordinator), Bruno Cañedo (Interior and Furniture Responsible), Israel San José (Domotics Coordinator), Miguel Herrero (Software Responsible) Leyre Morán (Hardware Responsible). **Team Members:** Laura Fernández, José Miguel Morales, Jesús Feijó, Eduardo Bermejo, Pablo García, Carlos Herrero, Álvaro Fraile, Alberto Cerro, Fernando Contreras, Miguel A. Padilla, Ana Ruth Grande, Marta Cuadrado, Enrique Garzón, Lidia Carrillo, Javier Rodríguez, Clara Puente, M^a Victoria Valero

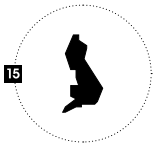

UNIVERSITY OF NOTTINGHAM

Final Location: Green Street, University Park, Nottingham, UK.

Faculty Members: Mark Gillott, Robin Wilson, Guillermo Guzman, David Oliver, Michael Stacey, Brian Ford, Lucelia Rodrigues, John Ramsey, Lyn Shaw, Mike Siebert. *Design Responsible:* **Architecture:** Ben Hopkins, Rachael Lee, Chris Dalton (Working in partnership with Marsh Grochowski Architects). **Structure:** Architecture team team working in partnership with Dewhurst Macfarlane Partners. **Electrical System:** Student team working in partnership with Evo Energy. **Photovoltaic System:** Student team working in partnership with Evo Energy **Mechanical System:** Student Team. **Team Members:**

Nina Hormazabal, Ben Hopkins, Rachael Lee, Chris Dalton, Jonathan Barron, Peter Blundy, Ashley Evans, Victoria Fillingham, Samuel Fullerteed, Alisdair Gray, Hannah Griffiths, Benjamin Heed, Simon Kinvig, Joe Leach, Stephen Lloyd, Daniel Mckie, Janet Pang, Trusha Patel, Elizabeth Vincent, Jose Andre, Christian Brailey, Tom Corbett, Emily Costain, Rebecca Ford, Philip Gilder, Teuta Hasani, Shui Hui, Chapman Kan, Unjulee Karadia, Frances Kirk, Manya Krishnaswamy, Frances Lister, Stephen Lovejoy, Rebecca Mak, Gareth Marriott, William Marshall, Bhavik Morar, Will Slack, Mustafa Tekman, Katherine Tokarski, Louise Vitty, Mang Wang, Long Xiang, Joseph Yates, Timeka Beecham.



TIANJIN UNIVERSITY

Final Location: Beijing.

Faculty Members: *Faculty Advisor:* Zhihua Chen, Yiping Wang. **Team Members:** Wangcheng Wang, Li Dan, Aiguo Wu, Xiangyu Yan, Hongsheng Wang, Hui Liu, Wenpeng Zhai, Dan Li, Zhihua Chen **Team Crew:** Jiming Li, Yufeng Liu **Faculty Advisor:** Yiping Wang, Zhihua Chen, Hui Gao, Kun Song **Decathlete:** Baoquan Yin, Zhen Wu, Yang Li, Sun Delong, Qian Liu, Yasha Zhang, Xiang-Gun Yang, Chi Li, Qiao Ning, Haotian Sun, Sumei Yang, Jiupeng Yu, ChunChang Wang, Guo Hu Ren, Binbin Ren, Hua Zhao, Jin Wang, Yuanpeng Gao, Shi Ying, Tao Fang, Zhangang Yang, Liang Jia, Jie Jia, Yingying Dai, Juanli Guo, Ben Niu, Wenbo Wang, Wei Wu, Yue Ren, Sheng Zhang, Yu Xiang, Wei Yang.



INSTITUTO DE ARQUITECTURA AVANZADA DE CATALUÑA

Final Location: Shanghai, China.

Faculty Members: Vicente Guallart (IaaC Director), Neil Gershenfeld (MIT-CBA Director), Daniel Ibañez (Co-Director de investigación del proyecto), Rodrigo Rubio (Project Investigation Co-Director). *Design Responsible:* **Architecture:** Vicente Guallart (IaaC Director), Neil Gershenfeld (MIT-CBA Director), Daniel Ibañez (Project Investigation Co-Director), Rodrigo Rubio (Project Investigation Co-Director). **Structure:** Diego Velayos (XTSarquitectura estructural) **Electrical System:** Juan Quero (Schneider Electric), Sergio Cantos (ADR), Ignacio de Ros (ADR) **Photovoltaic System:** Oscar Aceves (TFM energía solar fotovoltaica), Oliver Anzizu (Azimut360) **Mechanical System:** Joan Figueras (PGIGroup), Daniel Vilavendra (PGIGroup), Jordi Llosa (PGIGrou) **Researchers:** James Brazil, Cesar Daoud, Minnie Jan, Daisuke Nagamoto, Romuald Spilevski, Jezi Stankevici, Ricardo Zaldivar, David Moreno Rubio (external researcher), **Iaac Board:** Areti Markopoulou, Laia Pifarré, Willy Muller, Marta Malé-Aleman, Lucas Cappelli, Fernando Meneses, Daniela Frogheri, Hemant Purhoit, Cesar Cruz Casares, Luis Fraguada, Jorge Ramirez, *Fab Lab Barcelona:* Tomas Diez, Guillem Camprodon, Benito Juarez, Victor Frenundt, Aysheshim Tilahun, Melat Asefa, Susanna Tesconi, MAA Thesis Project **Students:** Melissa Mazik, Gopal Garg, Nicholas Waissbluth, Pedro Precedo, Mia Gorretti Layco, Paula Lucía López González, Fabio Andres Lopez Mora, Javier Palacios, Brian Miller, Natalija Boljsakov MIT Center For Bits and Atoms Kenny Cheung, Nadya Peek, David Kopp, Kerry Lynn, Amy Sun. **Students:** Gianluca Santosuosso, Leonidas Patarakis, Jeffrey Christopher Clarke, Jun

Huang, Marianne Villalobos Emonet, Ander Gortazar Balerdi, Jacek Markusiowicz, Georgia Kotsari, Eftychia Papatasiou, Paula Lucía López, María Lucía Mogollon, Kfir Gluzberg, Matheus Lopes, Viraj Kataria, Hristo Topchiev, Iliaria La Manna, Tamara Obradovic, Diana Bauder, Pedro Precado, Tomasz Starczewski, Eleni Kolovou, Veronica Lorenzo Luaces Pico, Emil Burulyanov, Kathleen Anderson, Ali Gharakhani, Edgar Bove, Michael Aaron Harrison Solar Energy Students: Qiuxiao Jian, Katerina Agorastaki, Jose Alvarez, Tatiana Anagnostara, Shradha Bhandari, Gianmatteo Cossu, Anastasia Fotopoulou, Rodolfo Baiz, Katerina Karagianni, Niovi Ketonis, Maria Koutsari, Karolina Kurzak, Sergio Leone, Guo Liang, Javier Martinez, Larisa Melnikova, Vangelis Moschonas, Vinay Patil, Christina Tsompanoglou, Alejandro Vega, Nathaniel Velez Summer Workshop Students: Slobodan Radoman, Athina Stamatopoulou, Rodrigo Toledo, Gabriel Ochoa, Kevin Vervuurt, Lourdes Marcano, Luis Odiaga, María Claudia Levy.



SOLAR DECATHLON EUROPE 2010 ORGANIZATION

General Management: *SDEurope Director:* Javier Serra María Tomé. *Institutional Director UPM:* José Manuel Páez. *UPM Architecture School Director:* Luis Maldonado Ramos. *SDEurope General Director, Project Manager:* Sergio Vega Sánchez. **Economic area:** *Administrative and Financial Management:* Responsible: Cristina Miró Pino, Team: Stefanía Montecé Aguirre, Kleber Chilán Loor, Dave Boyes, Mark Hallett, Verónica Franco Herrero, Alfredo Álvarez, Julián Chaparro, Ángel Hernandez, Antonio Rojo. **Communication area:** *Communication Manager:* Ismael Martínez Martín, *Team Coordinator:* Pablo

Villarejo Fernández. *Internal Communication:* Responsible: Jon Valdivia Merello, *Team:* David Sigüenza Pérez. *External Communication:* Responsible: Yolanda San Román Team: Claudia Estrella, Xiana Santos, María Felicidad Moreno, José Luis Rubial Moreno. **Marketing:** Responsible: Elena Gorostiza, Laura Reyero. *Team:* María Alberola, Helena Echavarrí. *Sponsors and Agents Coordination:* Responsible: Esther Garcés, *Team:* Manuel Gandarias Cebrián, Juan Ramón Sánchez Cifuentes, *Activities Organizers:* Responsible: Judith Martínez Martín, *Team:* Mónica Almagro Corpas, Blanca Fernández Megino, Katja Klinkenberg, Cristina Navas Perona. **Infrastructure area:** *Infrastructure manager:* Joara Cronemberger Ribeiro Silva, *Coordinator:* Juan Valero Muñoz. *Villa Solar Infrastructures:* Responsible: Raúl Rubio García, *Team:* José Miguel Reyes González, Jesús Pérez Aloe Mateos, Aitor Alarcía Mena, Enrique Avencio López Martínez, *Telecommunications:* Joaquín Ortigas, *Electrical Project:* Álvaro Zamora Morcillo, Santiago Romero Salgado, Juan Carlos Lafuente Sánchez. *Office building responsible:* Beatriz Arranz Arranz, Eva Gómez Aparicio. *Team:* Esther de Castro, Belén Sánchez Martínez, Elizabeth Magnolia Cuba Chara. *Site Operations:* Responsible: Diego Martínez Hernández, *Team:* Francisco Javier García Martínez, Miguel Ilundain. *Inspections and Safety:* Responsible: Letzai Ruiz Valero, *Team:* Pedro Antonio Beguería Latorre, Jesús Pérez Aloe Mateos, Cristóbal Contreras Pedraza, Juan Queipo del Llano Moya, Elena Frías. **Logistics and Services:** Responsible: Begoña Sabín Reina, *Team:* Marilyn López Gómez. **Competition area:** *Competition Manager:* Edwin Rodríguez Ubiñas. *Competition Strategies Manager:* Sergio Rodríguez Trejo. *Scientific Strategies Coordinator:* Claudio Montero Santos. *Competition, Rules and Regulations and Scientific Strategy team members:* María Porteros Mañueco, Claudia Zevallos, Jaime Promewongse Pérez, Gabriella Búlfa-

ro, Alicia Gimeno Blanco. *Participants Teams Coordination:* Responsible: María Barcia. *Monitoring:* Responsible: Sergio Rodríguez Requena. *Monitoring Team:* Andrea Ortiz Cuadros, Pablo González Cerame, Johan Gómez, Jorge Porro Bujedo, Elda Delgado, Juan Medina de Terán, Guillermo Temiño. *Competition Consultants:* Alfonso García Santos, Estefanía Caamaño Martín, Miguel Ángel Egido de Aguilera, Josep María Adell Argilés, Javier Neila González, César Bedoya Frutos, César Díaz Sanchidrián, Ignacio Valero Ubierna, Ramón Araujo, Manuel Castillo, Beatriz Rivela Carballal, Alvaro Gutiérrez Martín, Manuel Gandarias, Jorge Solórzano del Moral, Alberto Sánchez, Pablo Jiménez García, Carlos Espinosa Wilhemy, Domingo Guinea Díaz, Patriocio Alañón Olmedo, Eunat Buzunariz, José María Quero.



10ACTION TEAM

Project Leader: *Technical University of Madrid.* *Project Director:* Sergio Vega Sanchez. *Project Coordinator:* Katja Klinkenberg. *Team:* Mónica Almagro Corpas. **Project Partners:** *Austrian Energy Agency:* *Main Responsible:* Roland Hierzinger. *Team:* Marcus Hofmann, Alexandra Gros. *Technical University Darmstadt:* *Main Responsible:* Manfred Hegger. *Coordinator:* Caroline Faffolk. *Team:* Natalie Hajduk. *Institute for the Diversification and Saving of Energy:* *Main Responsible:* Virginia Vivanco Cohn. *Team:* Marcos González Álvarez. *Greece Energy Agency:* *Main Responsible:* Kiki Papadopoulou. *Coordinators:* Elena Taxeri, Giorgos Stathopoulos. *Portuguese Energy Agency:* *Main Responsible:* Luis Silva. *Marketing Company:* *Main Responsible:* Elena Gorostiza, Laura Reyero. *Team:* Maria Alberola, Helena Echavarrí.



Architecture Photo Workshop organized by SDEurope 2010 & PhotoEspaña 2010
Portraits by Juan Antonio Partal: One member of each team.



From left to right (page 248): Xu Tianping, Tongji University, China; Marcus Bui, Team Berlin, Germany; Noel Manzano, Universidad de Valladolid, Spain; Gloria Ituren, Ceu UCH Team Valencia, Spain; Brendan Wayman, Virginia Tech, USA; Baoquan Yin, Tianjin University, China; Jan Liffers, Team Wuppertal, Germany; Jeff Humpal, University of Florida, USA.

From left to right (page 249): Léa Viricel, Team Grenoble, France; Mathieu Condamine, ParisTech, France; Jaakko Pakkunen, Aalto University, Finland; Manuel Ogalla, Universidad de Sevilla, Spain; Andrei Mihalache, Universidad Politécnică de Catalunya, Spain; Pedro Precado, IAA de Catalunya, Spain; Michael Huber, Team Rosenheim, Germany; Unjulee Karadia, University of Nottingham, United Kingdom.



Architecture Photo Workshop organized by SDEurope 2010 & PhotoEspaña 2010

Pictures taken by some participants of the workshop: Walter Oscar, Angel Sampedro, Asier Rua, Luis Gomez Corona, Cristina Castro, Irene Castillo, Maria Jesus Huerta Arce.







sd europe

SOLAR DECATHLON

ORGANIZERS



MAIN SPONSOR



STRATEGIC SPONSOR



SPONSOR



COLLABORATORS





ten act10n

Supported by
INTELLIGENT ENERGY
EUROPE 

EUROPEAN PARTNERS



POLITÉCNICA



AUSTRIAN ENERGY AGENCY



AGÊNCIA PARA A ENERGIA



KAPE
CRES



TECHNISCHE
UNIVERSITÄT
DARMSTADT

emk
equipo de marketing